

Techniks CNC Tooling Solutions

- *CNC Toolholders*
- *Indexable Cutting Tools*
- *Magnetic Workholding*



TECHNIKS
BUILT FOR SPEED
www.techniksusa.com



An American
Company

2012

Techniks CNC Toolholders and Accessories

Collet & Nut Holders



CAT40 Holders

ER Collet Chucks	18
ER CoolFLEX.....	19
ER Mini Nut.....	20
ER SuperRIGID	21
ER DualDRIVE.....	22
SlimFIT Narrow Nose.....	23

CAT50 Holders

SlimFIT Holders	23
ER Collet Chucks	24
ER CoolFLEX.....	25
ER Mini Nut.....	26
ER SuperRIGID.....	27
ER DualDRIVE.....	28

BT30 Holders

ER Holders	29
ER Mini Nut	29
ER DualDRIVE.....	30
BT30, BT40 SlimFIT	31

BT40 Holders

BT40 ER Holders	32
BT40 ER CoolFLEX.....	33
BT40 ER Mini Nut.....	34
BT40 ER SuperRIGID.....	35

BT50 Holders

ER Holders	36
------------------	----

HSK Holders

HSKA ER Holders	37
HSK63A SlimFIT	38

CNC Router Holders

ISO ER, SK SYOZ Holders....	39
BT30, BT 35 Holders.....	40
HSKE & F ER Holders.....	41

Straight Shank Holders

ER Straight Shank Holders..	42
ER Coolant Straight Shanks	43

TG Holders

TG75, TG100 Holders.....	44
--------------------------	----

Set Screws & Specials

Set Screws & Torque Chart.	45
Special Order Holders.....	46

Collets and Nuts



ER Collets

ER Inch Sizes	48
ER Metric Sizes	50
DNA "Dead Nuts" ER	52

ER Coolant Collets

ER Steel Sealed Inch	54
ER Steel Sealed Metric	55
ER Sealed Collets	56

Tap Collets

ER Floating Tap Collets	57
ER Rigid Tap Collets.....	58
ER Quick-Change Collets....	60
Collet Storage Trays.....	61

Collet Nuts

PowerCOAT Nuts	62
PowerCOAT Mini Nuts.....	63
PowerCOAT Bearing Nuts....	63
Black Gold Coolant Rings....	64

TG Collets

TG75 Collets and Nut.....	66
TG100 Collets and Nut.....	67
TG100 Coolant Collets	68
TG150 Collets.....	69

Other Collets

SYOZ / EOC Collets.....	70
Double Angle DA Collets	71
Collet Identification Guide ...	72

Collet Specifications

Torque & Special Orders.....	72
------------------------------	----

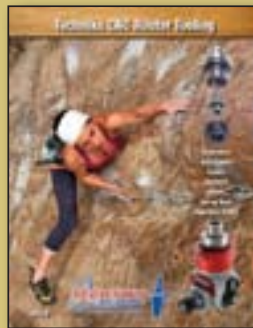

Call to get our 75 page
CNC Router Tooling catalog.

End Mill Holders



CAT40

Stubby Length	74
Regular Length.....	74
Extended Lengths.....	75
Rigid Reach	75



CoolBLAST Holders.....	76
CoolFLEX Holders	77
CoolBLAST & CoolFLEX.....	78
DualDRIVE Dual-Contact	79



CAT50

Stubby Length	80
Regular Length.....	80
Extended Length.....	81
Rigid Reach	81
CoolBLAST	82
CoolFLEX.....	83
DualDRIVE Dual-Contact	84

BT30

DualDRIVE Dual-Contact	85
Regular Length	85

BT40

Regular Length.....	86
Extended Length	87
Rigid Reach	87
CoolFLEX.....	88

BT50

Standard Length.....	89
----------------------	----



End Mill Lock Screws

End Mill Lock Screws	89
----------------------------	----



HSK

HSK63A, HSK100A.....	90
----------------------	----

ShrinkFIT Holders



CAT40

Regular Length.....	92
Extended Length.....	93
SlimLINE	93
Metric Size	94
CoolBLAST Holders	95
CoolFLEX Holders	95
CoolBLAST & CoolFLEX.....	96
DualDRIVE Dual-Contact	97



ShrinkLOC for PowerLOC ..	101
---------------------------	-----

CAT50

Regular Length.....	98
Extended Length.....	98
Metric Size	99
CoolBLAST Holders	100
ShrinkLOC for PowerLOC ..	101

BT30, BT40

Inch and Metric Sizes	102
-----------------------------	-----

HSKE

HSK40E Inch and Metric ...	103
HSK40E SlimLINE	103
HSK50E Holders	103

HSKA

HSK63A Regular Length....	104
HSK63A Extended Length .	104
HSK63A SlimLINE	104
HSK63A Metric Sizes	105
HSK63A CoolBLAST	105
HSK100A Holders	106

CNC Router ShrinkFIT

HSK63F and ISO30	107
------------------------	-----

ShrinkFIT Extensions

ShrinkFIT Extensions	108
----------------------------	-----

ShrinkFIT Case-Study

Cutting Test Results.....	109
---------------------------	-----

ShrinkFIT Machines

ShrinkSTATION	110
ShrinkPRO	111
ShrinkPRO Quencher	111

Techniks CNC Toolholders and Accessories

Other Holders



Face Mill Arbors

CAT40 Face Mill Arbors.....	114
CAT40 DualDRIVE	115
CAT50 Face Mill Arbors.....	116
CAT50 DualDRIVE	117
BT30 DualDRIVE	118
BT30 Face Mill Arbors.....	118
BT40 Face Mill Arbors.....	119
BT50 Face Mill Arbors.....	119
HSK Face Mill Arbors	120
Face Mill Arbor Screws	121



Milling Chucks

CAT40, 50, CoolBLAST	122
CAT40, 50 DualDRIVE	123
HSK63A, 100A,	122
Reduction Sleeves	124



Morse Taper

CAT40, CAT50	125
BT30, BT40, BT50	125



Hydraulic

CAT40, CAT50	126
Reduction Sleeves	127



SIMIS Toolholders

CAT40, 50 Collet Chucks...	128
CAT40, 50 Endmill Holders	129



Drill Chucks

Keyless Jacobs Chucks	130
HP3 High Precision	130
CAT, BT, SPU Chucks.....	130
CAT, BT Chuck Holders	131

Tap Holders



MicroFLOAT Tap System

About MicroFLOAT System	134
MicroFLOAT Tap Chucks ...	136
MicroFLOAT Extensions.....	137



Tension/Compression

CAT, BT Tap Chucks	138
HSK, Straight Shank	139

Rigid Tap

CAT, BT Tap Chucks	140
HSK, Straight Shank	141

ANSI Spec Tap Collets

Clutch Drive	142
Rigid Tap	143

Torque Chart

Tightening Specifications....	72
-------------------------------	----

Setup Equipment



Retention Knobs

CAT Retention Knobs	200
BT Retention Knobs	201
DAT Knobs (DIN 69871) ...	202
CNC Router Knobs	203
Torque Specifications	144

Wrenches

Hand Wrenches	204
Torque Wrenches.....	205
Torque Wrench Adapters ..	205

Other Setup Equipment

Tightening Fixtures	206
Spindle Wipers	207
Preset Gauges	207
Set Screws.....	208



HSK Coolant Pipe.....	37
-----------------------	----

Boring Tools



BohrSTAR Boring Kits

About BohrSTAR Kits.....	146
BohrSTAR 100 Kit.....	148
BohrSTAR 170 Kit.....	149
BohrSTAR 210 Kit.....	150
BohrSTAR Kit Toolholders..	151



Pinzbohr Modular Tools

About Modular System.....	152
Choosing A Boring Head ...	155
Boring Bars	157
Boring Bar Heads	159
Rough Heads	160
Finish Heads.....	164

Cartridges & Inserts

Indexable Cartridges	168
----------------------------	-----



HIGH-PERFORMANCE

Nexus Lamina Inserts	169
----------------------------	-----

Boring Head Toolholders

CAT40, 50 Holders.....	172
BT30, 40, 50 Holders.....	176
HSK 50A, 63A, 100A.....	178
Weldon and R8 Holders	179
Large Head Holders	180

Extensions & Reducers

Extensions & Reducers	182
Chamfering Heads	183

Modular Toolholders

End Mill Holder	184
Face Mill Arbor	184

Miscellaneous

Feeds and Speeds	185
Spare Parts	186

Capto Compatible*



Collet Chucks

C4 Collet Chucks	192
C5 Collet Chucks	192
C6 Collet Chucks	192



End Mill Holders

C4 End Mill Holders	193
C6 End Mill Holders	193



ShrinkFIT Holders

C4 ShrinkFIT Holders	194
C5 ShrinkFIT Holders	194
C6 ShrinkFIT Holders	194



SlimFIT Holders

C4 SlimFIT Holders	195
C6 SlimFIT Holders	195



Face Mill Arbors

C4 Face Mill Arbors	196
C5 Face Mill Arbors	196
C6 Face Mill Arbors	196



C6 External Turning

C6 External Turning Tools .	197
-----------------------------	-----

HIGH-PERFORMANCE

Distributors Only

Distributor's Webstore

Call us for webstore access.

Part No. / Page No.

Products by part number .. 286

*Compatible with the Capto tool system. Techniks products are not affiliated with or endorsed by Sandvik AB.

Nexus Face Mills



ShrinkMILL Face Mills

About ShrinkMILL	209
90° ShrinkMILL	212
45° ShrinkMILL	213
High-Feed ShrinkMILL	214



Nexus Face Mills

90° Face Mills	216
45° Face Mills	217
High-Feed Face Mills	218



HIGH-PERFORMANCE

High-Feed Inserts

Nexus Lamina 8-edge Inserts	219
-----------------------------------	-----



Cast Iron Cutter

Decagon Cutter	220
----------------------	-----



Positive High-Feed

Tetrad Cutter	221
---------------------	-----

Nexus Milling Inserts

Nexus Lamina Inserts	222
Nexus Milling Inserts	223
Machining Guides	224-228

Nexus End Mills



PowerLOC Indexable End Mills

About PowerLOC	229
PowerLOC End Mills	232

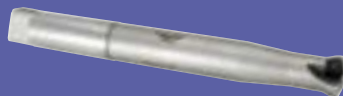

PowerLOC High-Feed	233
--------------------------	-----

PowerLOC Adapter



PowerLOC Adapters	234
PowerLOC Toolholders	234



High-Feed Inserts

Nexus Lamina 8-edge	235
---------------------------	-----

Nexus End Mills

Indexable End Mills	236
Positive High-Feed	237



HIGH-PERFORMANCE

Nexus Milling Inserts

Nexus Milling Inserts	238
Machining Guides	239-243



Nexus Indexable Drills

4WD Indexable Drills	244
----------------------------	-----

Nexus Turning Tools



Negative Turning Tools

MCLNR & MDJNR	246
MVJNR & MWLNR	247

Negative Boring Bars

PCLNR & PDUNR	248
PVUNR & PWLNR	249

Negative Turning Inserts



HIGH-PERFORMANCE

Nexus Lamina Inserts	250
Nexus Negative Turning Inserts	251

Positive Turning Tools

SCLCR, STGCR, SDJCR	252
---------------------------	-----

Positive Boring Bars

SCLCR, SDUCR	253
STFCR	254

Positive Turning Inserts

Nexus Lamina Inserts	255
Nexus Positive Turning Inserts	256
Machining Guides	257
Master Insert List	258-260

Product Cross-Reference

Products by Part No.	262
Products by Description	266
Replacement Hardware	270



Earth-Chain Magnetic Products

Magnetic Workholding



EEPM Workholding Chucks
 About EEPM Workholding Chucks..... 272
 EEPM Workholding Chucks 274

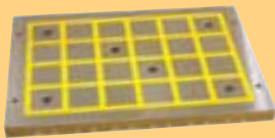

EEPM Subplates 274

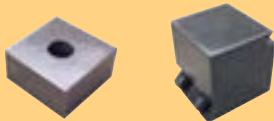

EEPM Chuck Induction Blocks..... 275
 EEPM Tombstone Solutions..... 275

ECB Magnetic Vises



About ECB Workholding Vises 276
 ECB Workholding Vises 277
 ECB Chuck Induction Blocks 277



Lifting Magnets



ELM Lifting Magnets
 About ELM Lifting Magnets..... 278
 ELM Application Examples 279
 ELM Lifting Magnets..... 280
 Calculating Maximum Loads..... 280

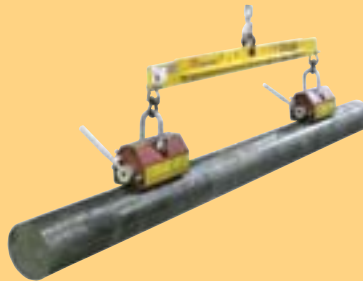

EZ-Lift Spreader Bars 281



Vertical Lifters 281



Magnetic Deburring



SPINner Deburring Machine
 About Magnetic Deburring 282



Typical Deburred Parts..... 283
 Deburring Examples 283
 SPINner Deburring Machines..... 285



Replacement Media..... 284



PFS-747 Deburring Solution 284

Call (800) 597-3921 for fast, friendly answers to your questions.

New! Capto-Compatible* Tools – C4, C5, C6

The same great Techniks Certified toolholders you are used to... now Capto-Compatible*



ER Collet Chucks

- *Balanced at 25,000 RPM*
- *See page 192*



End Mill Holders

- *H5 precision bore*
- *See page 193*



SlimFIT Holders

- *Nose diameter .55"*
- *See page 195*



ShrinkFIT

- *.0001" T.I.R.*
- *See page 194*



Face Mill Arbors

- *H6 arbor spec*
- *See page 196*



Turning Tools

- *External turning*
- *See page 197*



*Compatible with the Capto tool system. Techniks products are not affiliated with or endorsed by Sandvik AB.

NEW! – MicroFLOAT Modular Tapping System

Techniks MicroFLOAT: 0.0008" compression / 0.040" tension

see pg. 134



MicroFLOAT is the most flexible, modular tapping system available.

Features

- Increase tap life
- decrease scrap
- reduce breakage



Up to 9" of extension with all MicroFLOAT modular parts

Advantages

- Great for machines with backlash in spindle
- Great for production tapping and high tolerance tapping

MicroFLOAT Tension / Compression

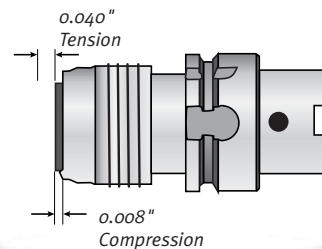

High-Pressure Coolant Enabled



Featured Technology – DualDRIVE Toolholders

Techniks DualDRIVE for Dual-Contact Machines



see pg. 22

DualDRIVE
ER Collet Chucks



see pg. 79

DualDRIVE
Endmill Holders



see pg. 97

DualDRIVE
ShrinkFIT Holders



see pg. 115

DualDRIVE
Face mill Arbors

DualDRIVE for DUAL-CONTACT Machining

- **DUAL-CONTACT** improves rigidity, reduces vibration
- Increase feed rates up to 20%
- Available CAT40, CAT50, BT30 spindles
- CoolFLEX DIN B coolant feature on ER Collet Chucks and ShrinkFIT toolholders

DualDRIVE For Dual Contact

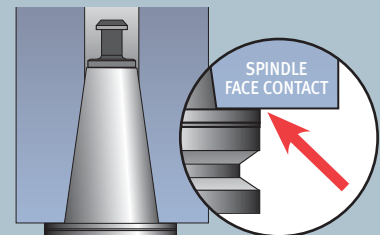
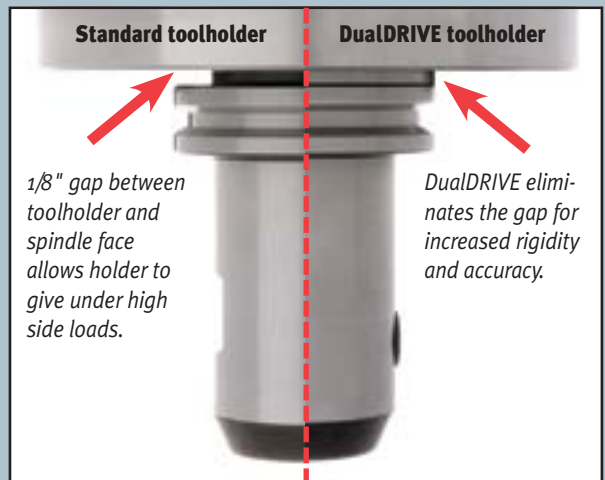

DualDRIVE eliminates gap between flange and spindle for increased rigidity.

For **DUAL CONTACT** spindles

DUAL-CONTACT with spindle taper and face provides increased rigidity.

Use when high metal removal rates, high-speed, and/or machining at extended lengths is desired.



IMPROVES T.I.R.

Featured Technology – CoolBLAST and CoolFLEX

CoolBlast Puts Coolant Right on Toolpath

- No need for coolant-thru tools
- CoolFLEX for DINB coolant-thru flange

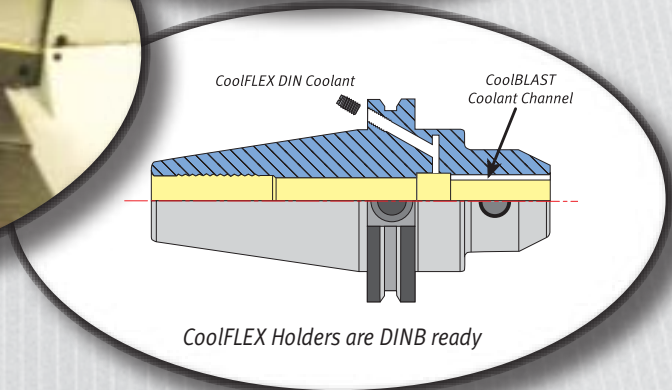
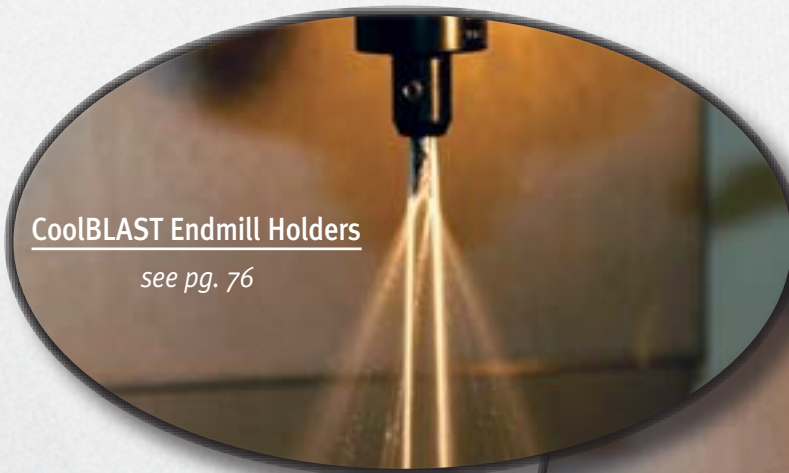

What Does Techniks Certified Mean?

Techniks Certified = Manufactured to The Highest Standards



Techniks Certified Tooling means the critical features of each holder has been individually lab tested, measured and inspected for quality. Depending on the holder this can include: balance, dimensional accuracy, collet pocket runout (T.I.R.), bore I.D. and taper accuracy. Techniks Certified guarantees your holder will meet or beat our published specifications.

Lab Certified Accuracy

Each toolholder is lab certified for accuracy and balance.

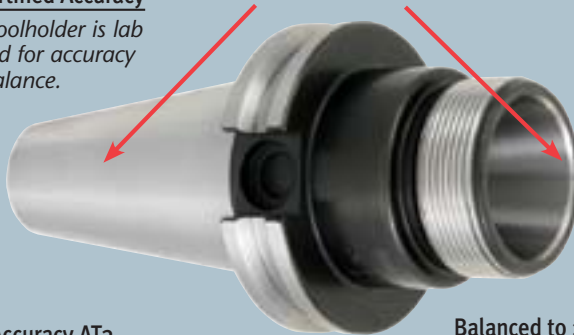

Taper-to-Pocket T.I.R. 0.0001"

Measured from taper O.D. to collet pocket I.D.

Ultra Precision Collet

Each collet hand inspected. T.I.R. only 0.0002"

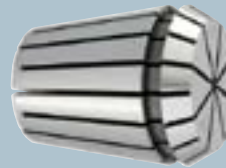

PowerCOAT Nuts

Our PowerCOAT nut holds 70% tighter than standard nuts for best T.I.R. and rigidity.



Taper Accuracy AT3

Taper ground to AT3 accuracy for maximum contact with spindle.

Balanced to 25,000 RPM

Factory balanced to 25,000 RPM at G2.5
Custom balancing to 60,000 RPM available.

Balanced Nut

Balanced nut reduces vibration to extend cutting tool life.

Endmill Holder Bore Tolerance is H5 – Best in The Industry Improves Accuracy and Tool Life



Others T.I.R. .0008"

Techniks .0002"

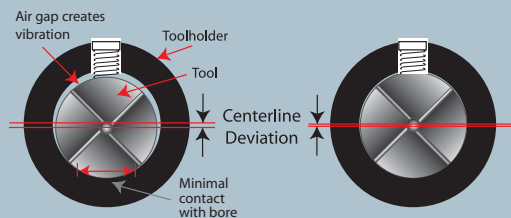

A full report comes with each holder

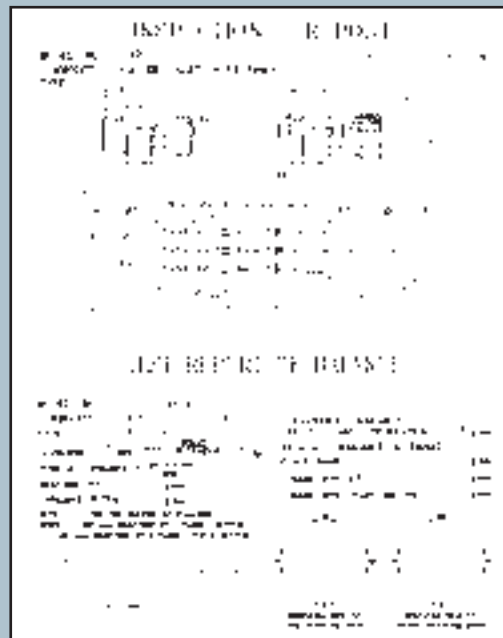

Use Techniks Certified for improved performance and extended cutting tool life.

Save Big With Techniks Tooling Packages



We have tooling packages available for practically every CNC machine made. Call (800) 597-3921 and ask about a package for your machine and spindle type. (...ask about our Tooling Certificates for new machine toolup)

CAT40 – Sale: \$1,690 (original price \$2,409)
No. TP-C40, 43 piece CAT40 Tooling Package

Save \$719



Qty.	Part No.	Description	Cost	Extension
4	22253	CAT40 x ER 32 - 2.76	\$153.00	\$612.00
2	22225	CAT40 x ER 16 - 2.76	\$143.00	\$286.00
1	04212 (set)	ER 32 x 18 piece collet set - Inch	\$486.00	\$486.00
1	04209 (set)	ER 16 x 10 piece collet set - Inch	\$233.50	\$233.50
1	22911	CAT40 x SLN 1/4" - 3"	\$85.00	\$85.00
1	22915	CAT40 x SLN 3/8" - 3"	\$85.00	\$85.00
1	22917	CAT40 x SLN 1/2" - 3"	\$85.00	\$85.00
1	22919	CAT40 x SLN 5/8" - 3"	\$85.00	\$85.00
1	22921	CAT40 x SLN 3/4" - 3.5"	\$95.00	\$95.00
1	22925	CAT40 x SLN 1" - 4"	\$95.00	\$95.00
1	22403	CAT40 x SPU 1/2" - 4"	\$228.00	\$228.00
1	04616	ER 32 - E WRENCH	\$20.00	\$20.00
1	04609	ER 16 - A WRENCH	\$13.50	\$13.50

CAT50 – Sale: \$2,370 (original price \$2,976)
No. TP-C50, – 45 piece CAT50 Tooling Package

Save \$606



Qty.	Part No.	Description	Cost	Extension
5	22291	CAT50 x ER 20 - 4	\$180.00	\$900.00
5	22311	CAT50 x ER 32 - 4	\$170.00	\$850.00
1	04212(set)	ER 32 x 18 piece collet set - in.	\$486.00	\$486.00
1	04210(set)	ER 20 x 12 piece collet set - in.	\$306.00	\$306.00
2	22945	CAT50 x SLN 1- 4	\$130.00	\$260.00
1	22947	CAT50 x SLN 1-1/4 - 4.6	\$134.00	\$134.00
1	04610	ER 20 - A wrench	\$20.00	\$20.00
1	04616	ER 32 - E wrench	\$20.00	\$20.00

BT40 – Sale: \$1,598 (original price \$2,078)
No. TP-B40, – 41 piece BT40 Tooling Package

Save \$480



Qty.	Part No.	Description	Cost	Extension
2	06151	BT40 X ER 16-70	\$140.00	\$280.00
1	04209(set)	ER16 X 10 pc. collet set - inch	\$233.50	\$233.50
4	06177	BT40 X ER 32-70	\$150.00	\$600.00
1	04212(set)	ER 32 x 18 piece collet set - inch	\$486.00	\$486.00
1	07140-3/8	BT40 x SLN 3/8" - 2-1/2"	\$89.00	\$89.00
1	07140-1/2	BT40 x SLN 1/2" - 2-1/2"	\$89.00	\$89.00
1	07140-5/8	BT40 x SLN 5/8" - 2-1/2"	\$89.00	\$89.00
1	07140-3/4	BT40 x SLN 3/4" - 2-1/2"	\$89.00	\$89.00
1	07140-1	BT40 x SLN 1" - 3-9/16"	\$89.00	\$89.00
1	04609	ER 16 - A wrench	\$13.50	\$13.50
1	04616	ER 32 - E wrench	\$20.00	\$20.00

Solutions that are innovative, accurate, and simple.

Techniks Toolholders

- *Minimize T.I.R.*
- *Maximize rigidity*
- *Increase tool life*



Accurate

High-Performance Inserts

- *Eliminate insert guesswork*
- *Minimize set up time*
- *Maximize machine time*



Simplify

PowerLOC

- *Eliminate milling chucks*
- *Minimize set up time*
- *Maximize machine time*

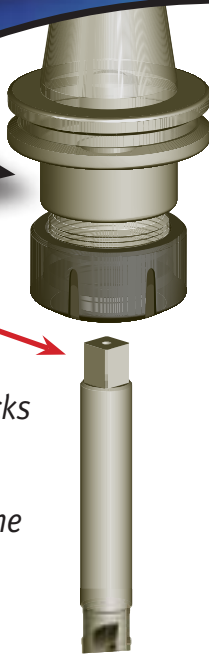

ShrinkMILL

- *Perfect ShrinkFIT connection*
- *30% less runout*
- *Longer insert life*

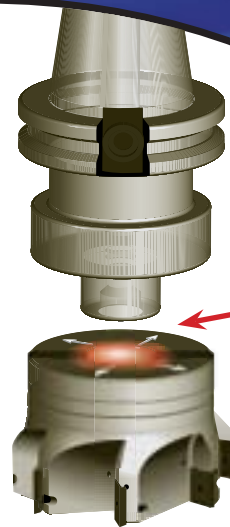

Innovative

**We're Making a Better Connection
Between the Cutting Tool and Spindle.**

Attacking Heat & Vibration is in Our DNA.

Solutions that are innovative, accurate, and simple.

The LAMINA Difference

- Milling
- Boring
- Turning

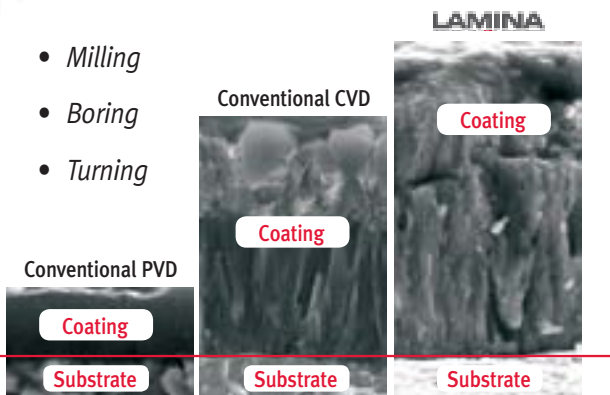

- High-Performance Inserts eliminates insert guesswork and reduces insert inventory
- Thickest PVD coating in the industry
- Far stronger than standard CVD coating
- Unique edge preparation improves consistency of coating
- Excellent results in high temp alloys

HIGH-PERFORMANCE
3x the Thickness of Conventional PVD!

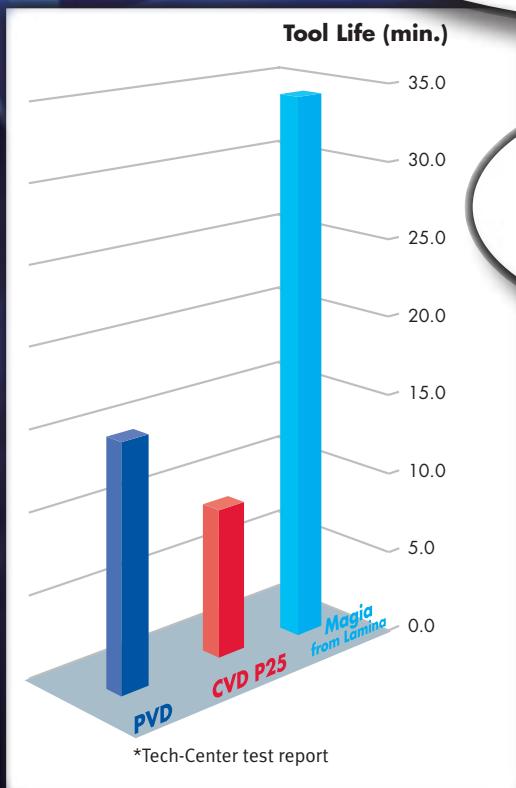

Greater Tool Life with Nexus Lamina Inserts



Solutions that are innovative, accurate, and simple.



ShrinkMILL Face Mills

- The holding power and rigidity of ShrinkFIT applied to a face mill
- Coolant thru tool
- Extended insert life

see pg. 209



SHRINKMILL
PATENTED TECHNOLOGY

Innovative



**We're Making a
Better Connection
Between the Cutting Tool
and Spindle.**

HIGH-PERFORMANCE
3x the Thickness of Conventional PVD!



Simplify

Attacking Heat & Vibration is in Our DNA.

Solutions that are innovative, accurate, and simple.

PowerLOC Indexable End Mills

- *Much better accuracy*
- *Better balance*
- *Positively grips the tool shank*



**Simplify
Innovative**

**We're Making
a Better Connection
Between the Cutting Tool
and Spindle.**

see pg. 229



Features

- *High-Performance inserts eliminates guesswork*
- *Exceptional performance in high temp alloys*

HIGH-PERFORMANCE
3x the Thickness of Conventional PVD!



Negative turning & boring tools

Positive turning & boring tools



see pg. 245



Earth-Chain MagVISE Workholding



see pg. 272

- 26 sizes standard
- Turnkey workholding solutions

EEPM Magnetic Chucks

- *Slash setup and part change over times*
- *Machine 5 sides and through hole drilling*
- *For large and small workpieces*

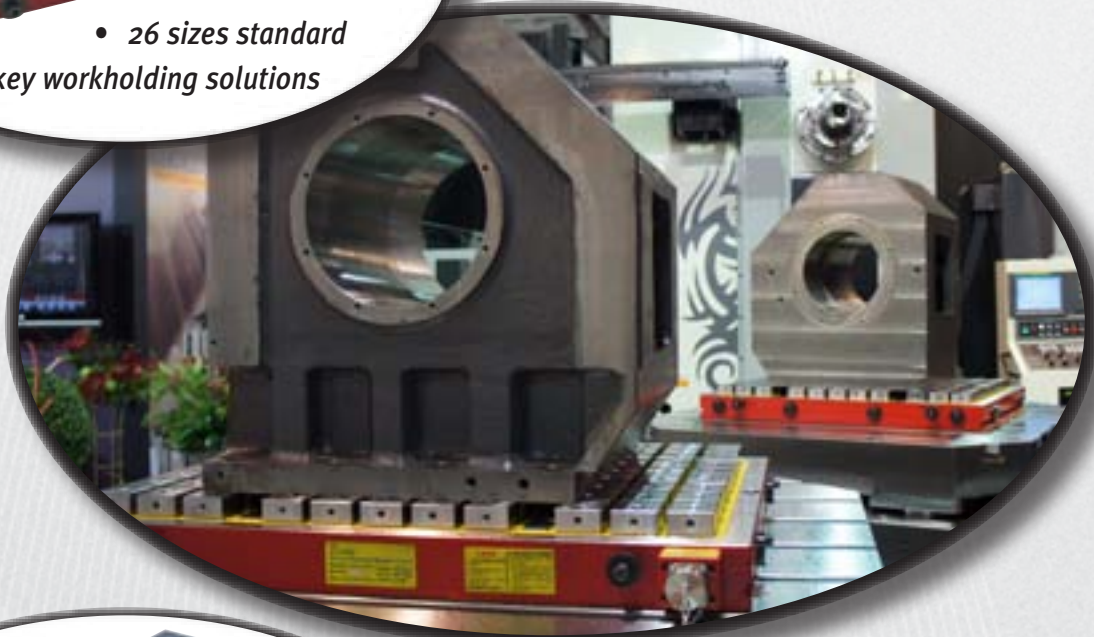

- 4 sizes available
- see pg. 276

ECB Magnetic Vises

- *Slash setup and part change over times*
- *Machine 5 sides and through hole drilling*





The Safest and Fastest Way to Move Stock and Workpieces

6 Sizes Available

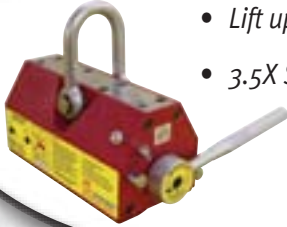

- Lift up to 6,600 lbs
- 3.5X Safety Factor

see pg. 278



Featured Technology – PowerCOAT Nut

PowerCOAT Nuts provide 75% more holding power than bearing nuts.

Our PowerCOAT nut *reduces friction between the nut and collet shoulder, and on all threaded surfaces*, so the nut can compress the collet deeper into the pocket and hold the shank tighter. This is why PowerCOAT nuts hold 75% tighter than standard collet nuts. (see table below)

Watch the holding power testing video at:
www.techniksusa.com/pcnut

Features

- Increases holding power by 75%
- Balanced to 25,000 RPM
- Better rigidity and less T.I.R. (runout)



PowerCOAT Nut Benefits

- Cutting tools last longer – reduced costs
- Less scrap and better surface finish
- High holding power reduces tool breakage

Holding Power Testing – ft./lbs

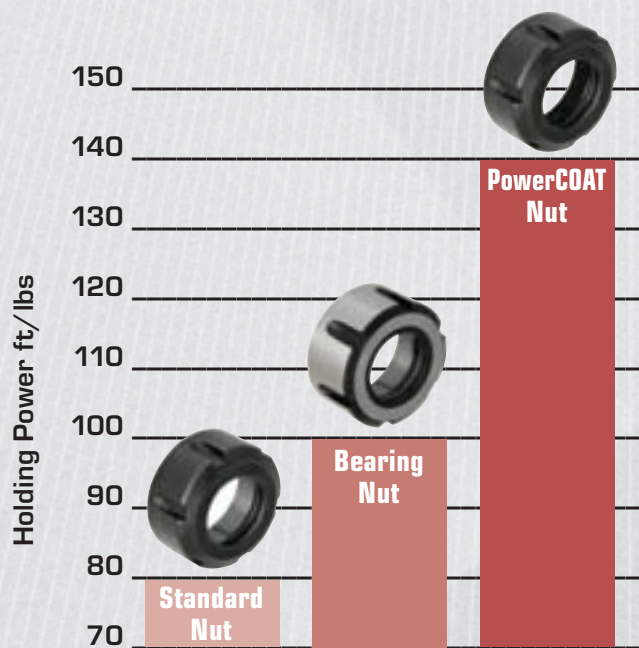

Each nut was tightened to 70 ft/lbs recommended torque before break-free testing of holding power.

How Rigidity Affects Cutting Tool Life

T.I.R. (runout) of a toolholder/cutting tool assembly can be perfect on the test stand, but if the toolholder is not rigid enough to withstand the lateral pressure of cutting metal, “in the cut” tool life will be poor, and tooling costs high. Techniks PowerCOAT nut provides the highest holding power for maximum rigidity and accuracy (T.I.R.) to extend cutting tool life.

You lose 10% tool life with every .0001" runout.

Precision Collet and Nut Style Toolholders

Techniks toolholders improve performance and extend tool life.

Balanced to 25,000 RPM
Balanced to 25,000 RPM at G2.5. Custom balancing to 60,000 RPM available.

Taper Accuracy AT3
Taper ground to AT3 accuracy for maximum contact with spindle.

TECHNIKS CERTIFIED ACCURACY BALANCE

T.I.R. 0.0001" or better!
Measured from taper O.D. to collet pocket I.D.

Lab Certified Accuracy
Each toolholder is lab certified for accuracy and balance.

Inch and Metric Sizes

Sealed

Steel Sealed

T.I.R. 0.0002"

Quick-Change Tap

Floating Tap

Rigid Tap

PowerCOAT Nuts
Special PowerCOAT nut holds up to 75% tighter for best T.I.R., rigidity, and safety.

Extend Tool Life
PowerCOAT nut is balanced for reduced vibration at high speed to extend tool life.

You lose 10% of tool life for every .0001" of T.I.R. The rigidity and accuracy of Techniks toolholders minimizes T.I.R. and extend cutting tool life.

Built for Speed.

CAT40 Precision ER Toolholders



Techniks Certified for accuracy and balance
Each holder comes with a complete lab report

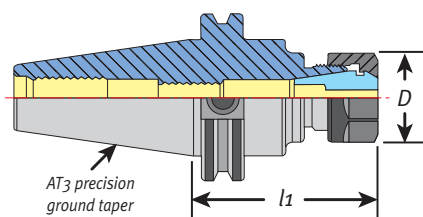

Features

- Balanced to 25,000 RPM at G2.5
- T.I.R. 0.0001" measured from taper to collet pocket
- PowerCOAT nut included for 75% more clamping power



Collets
pg. 48



Nuts
pg. 62



Coolant
Rings
pg. 64



Retention
Knobs
pg. 200



Wrenches
pg. 204



Tightening
Stands
pg. 206

For ER16 and 20 slotted nuts, simply add **SLOTNUT** to the end of the part number. For holders with coolant nut included add **-C** to the end of the part number. Coolant nuts are not available for ER11 or ER50.

CAT40 ER Toolholders

Part No.	Description	l1	D	Max. Shank	Stop Screw	Wrench
22213-3	CAT40 x ER11 - 3", hex nut	3"	.748"	.275"	06081	04608
22225	CAT40 x ER16 - 2.76", hex nut	2.76"	1.08"	.406"	06083	04609
22227	CAT40 x ER16 - 4", hex nut	4"	1.08"	.406"	06083	04609
22231	CAT40 x ER16 - 6", hex nut	6"	1.08"	.406"	06083	04609
22233	CAT40 x ER16 - 8", hex nut	8"	1.08"	.406"	06083	04609
22235	CAT40 x ER20 - 2.76", hex nut	2.76"	1.34"	.512"	06087	04610
22237	CAT40 x ER20 - 4", hex nut	4"	1.34"	.512"	06087	04610
22239	CAT40 x ER20 - 6", hex nut	6"	1.34"	.512"	06087	04610
22243-2.5	CAT40 x ER25 - 2.5", slotted nut	2.5"	1.65"	.630"	06089	04615
22243	CAT40 x ER25 - 2.76", slotted nut	2.76"	1.65"	.630"	06089	04615
22245	CAT40 x ER25 - 4", slotted nut	4"	1.65"	.630"	06089	04615
22247	CAT40 x ER25 - 6", slotted nut	6"	1.65"	.630"	06089	04615
22251	CAT40 x ER25 - 8", slotted nut	8"	1.65"	.630"	06089	04615
22253	CAT40 x ER32 - 2.76", slotted nut	2.76"	1.97"	.788"	06089	04616
22255	CAT40 x ER32 - 4", slotted nut	4"	1.97"	.788"	06089	04616
22257	CAT40 x ER32 - 6", slotted nut	6"	1.97"	.788"	06089	04616
22259	CAT40 x ER32 - 8", slotted nut	8"	1.97"	.788"	06089	04616
22261	CAT40 x ER40 - 3.15", slotted nut	3.15"	2.48"	1.023"	06091	04617
22263	CAT40 x ER40 - 4", slotted nut	4"	2.48"	1.023"	06091	04617
22265	CAT40 x ER40 - 6", slotted nut	6"	2.48"	1.023"	06091	04617
22269	CAT40 x ER50 - 4", slotted nut	4"	3.07"	1.338"	06093	04618

CAT40 Precision CoolFLEX ER Toolholders



PowerCOAT nut is included with each holder.
Techniks Certified for accuracy and balance
Each holder comes with a complete lab report

Features

- Coolant-thru spindle or thru flange (DIN B)
- Balanced to 25,000 RPM at G2.5
- T.I.R. 0.0001" or better from taper to collet pocket

CoolFLEX Feature

CoolFLEX holders are factory set for coolant-thru spindle. Simply remove 2 stop screws for DIN B coolant-thru flange.

For ER16, and 20 slotted nuts, simply add SLOTNUT to the end of the part number. For holders with coolant nut included add -C to the end of the part number.

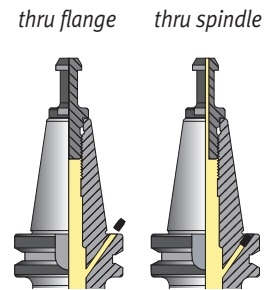
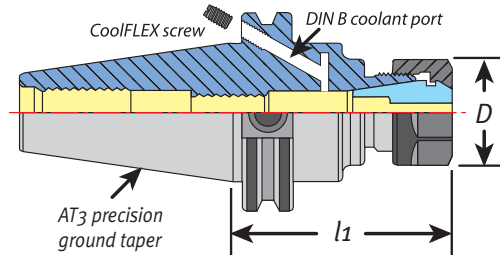

Replacement CoolFLEX Screws

Part No. Description

HSA-4-6 40 taper DIN B screw

Coolant Set Screws page 45.

CAT40 CoolFLEX Coolant -Thru Spindle or Flange (DIN B)

Part No.	Description	l1	D	Max. Shank	Stop Screw	Wrench
22225F	CAT40 x ER16 - 2.76", hex nut	2.76"	1.08"	.406"	06083	04609
22227F	CAT40 x ER16 - 4", hex nut	4"	1.08"	.406"	06083	04609
22231F	CAT40 x ER16 - 6", hex nut	6"	1.08"	.406"	06083	04609
22233F	CAT40 x ER16 - 8", hex nut	8"	1.08"	.406"	06083	04609
22235F	CAT40 x ER20 - 2.76", hex nut	2.76"	1.34"	.512"	06087	04610
22237F	CAT40 x ER20 - 4", hex nut	4"	1.34"	.512"	06087	04610
22239F	CAT40 x ER20 - 6", hex nut	6"	1.34"	.512"	06087	04610
22243F	CAT40 x ER25 - 2.76", slotted nut	2.76"	1.65"	.630"	06089	04615
22245F	CAT40 x ER25 - 4", slotted nut	4"	1.65"	.630"	06089	04615
22247F	CAT40 x ER25 - 6", slotted nut	6"	1.65"	.630"	06089	04615
22251F	CAT40 x ER25 - 8", slotted nut	8"	1.65"	.630"	06089	04615
22253F	CAT40 x ER32 - 2.76", slotted nut	2.76"	1.97"	.788"	06089	04616
22255F	CAT40 x ER32 - 4", slotted nut	4"	1.97"	.788"	06089	04616
22257F	CAT40 x ER32 - 6", slotted nut	6"	1.97"	.788"	06089	04616
22259F	CAT40 x ER32 - 8", slotted nut	8"	1.97"	.788"	06089	04616
22261F	CAT40 x ER40 - 3.15", slotted nut	3.15"	2.48"	1.023"	06091	04617
22263F	CAT40 x ER40 - 4", slotted nut	4"	2.48"	1.023"	06091	04617



All Techniks products are backed by our 100% satisfaction guarantee!

CAT40 Precision ER Mini Nut Holders



PowerCOAT nut is included with each holder.
Techniks Certified for accuracy and balance
Each holder comes with a complete lab report

Features

- Narrow nut diameter for better clearance
- Balanced to 25,000 RPM at G2.5
- T.I.R. 0.0001" measured from taper to collet pocket



Collets
pg. 48



Nuts
pg. 62



Coolant
Rings
pg. 64



Retention
Knobs
pg. 200



Wrenches
pg. 204



Tightening
Stands
pg. 206

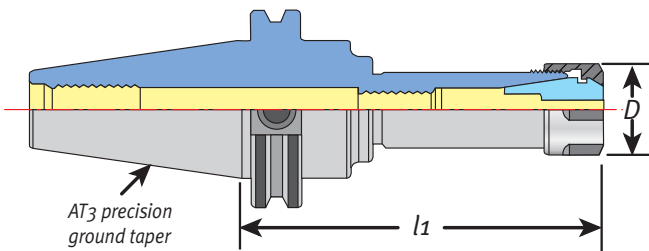

Coolant Options

- ER coolant rings (pg. 64)
- ER Steel Sealed collets (pg. 54)
- ER coolant collets (pg. 56)

CAT40 ER Mini Nut Holders

Part No.	Description	l1	D	Max. Shank	Stop Screw	Wrench
22352	CAT40 x ER11 - 2.75", mini nut	2.75"	.63"	.275"	06081	04621
22354	CAT40 x ER11 - 4", mini nut	4"	.63"	.275"	06081	04621
22354-6	CAT40 x ER11 - 6", mini nut	6"	.63"	.275"	06081	04621
22354-8.5	CAT40 x ER11 - 8.5", mini nut	8.5"	.63"	.275"	06081	04621
22356	CAT40 x ER16 - 2.76", mini nut	2.76"	.87"	.406"	06083	04622
22358	CAT40 x ER16 - 4", mini nut	4"	.87"	.406"	06083	04622
22359	CAT40 x ER16 - 6", mini nut	6"	.87"	.406"	06083	04622
22359-8	CAT40 x ER16 - 8", mini nut	8"	.87"	.406"	06083	04622
22360	CAT40 x ER20 - 2.76", mini nut	2.76"	1.102"	.512"	06087	04623
22362	CAT40 x ER20 - 4", mini nut	4"	1.102"	.512"	06087	04623

CAT40 Precision ER32 SuperRIGID Holders



Collet nut is included with each holder.
Techniks Certified for accuracy and balance
Each holder comes with a complete lab report

Features

- *Balanced to 25,000 RPM at G2.5*
- *Best T.I.R. of any collet chuck*
- *Best Z axis clearance of any collet chuck*
- *SuperRIGID design is great for heavy side loads*



Standard collet chuck



SuperRIGID collet chuck



Use SuperRIGID holders with ER32 collets.
For coolant applications use our ER32 Steel Sealed coolant collets (page 54).



Standard collet chucks have more than double the projection of SuperRIGID chucks.



Minimal projection maximizes rigidity. SuperRIGID holders are an ideal choice for high speed or high torque machining.

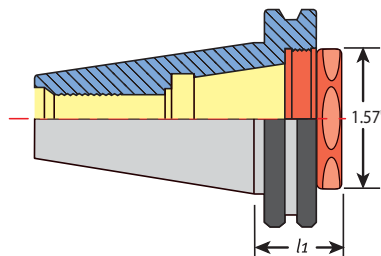

PowerCOAT Replacement Nut

CAT40 SuperRIGID ER Toolholders

Part No.	Description	l1	Collet	Max. Shank	Wrench
22253S	CAT40 x ER32	1.10"	ER32	3/4" or 20mm	894-36
TE-22HN	hex style nut				



All Techniks products are backed by our 100% satisfaction guarantee!

CAT40 Precision DualDRIVE Toolholders



PowerCOAT nut is included with each holder.
Techniks Certified for accuracy and balance
Each holder comes with a complete lab report

Benefits

- Better rigidity and reduced vibration
- Improved performance at high metal removal rates and when machining at extended lengths
- Provides the benefits of dual-contact machining on standard spindles too!

CoolFLEX Feature

CoolFLEX holders are factory set for coolant-thru spindle. Simply remove 2 stop screws for DIN B coolant-thru flange.

Coolant Set Screws page 45.

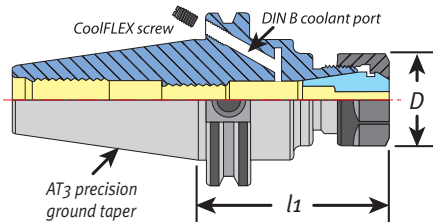

CAT40 DualDRIVE Coolant -Thru Spindle or Flange (DIN B)

Part No.	Description - L1	L1	D	Collet	Max. Shank	Set Screw	Wrench
72225	CAT40 x ER16 -2.76" DualDRIVE	2.76"	1.08"	ER16	.406"	06083	04609
72227	CAT40 x ER16 - 4" DualDRIVE	4"	1.08"	ER16	.406"	06083	04609
72231	CAT40 x ER16 - 6" DualDRIVE	6"	1.08"	ER16	.406"	06083	04609
72233	CAT40 x ER16 - 8" DualDRIVE	8"	1.08"	ER16	.406"	06083	04609
72253	CAT40 x ER32 - 2.76" DualDRIVE	2.76"	1.97"	ER32	.788"	06089	04616
72255	CAT40 x ER32 - 4" DualDRIVE	4"	1.97"	ER32	.788"	06089	04616
72257	CAT40 x ER32 - 6" DualDRIVE	6"	1.97"	ER32	.788"	06089	04616
72261	CAT40 x ER40 - 3.15" DualDRIVE	3.15"	2.48"	ER40	1.023"	06091	04617

Features

- Use with existing dual-contact spindles
- Coolant-thru spindle or thru flange (DIN B)
- Balanced to 25,000 RPM at G2.5

DualDRIVE For dual contact

Standard toolholder

1/8" gap between toolholder and spindle face allows holder to give under high side loads.

DualDRIVE toolholder

DualDRIVE eliminates the gap for increased rigidity and accuracy. Works with any CAT40 spindle.

US Patent 7393166B23

See an on machine demonstration video of DualDRIVE compared to standard toolholders at: www.techniksusa.com/videos2008/DD

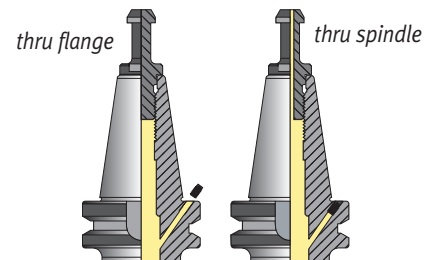

Replacement CoolFLEX Screws

Part No.	Description
HSA-4-6	40 taper DIN B screw

CAT40, 50 Precision SlimFIT Toolholders



Internal drawbar collet eliminates need for clamping nut to permit narrow nose diameter. 4° collet provides greater holding power and improved accuracy.



Coolant-thru design

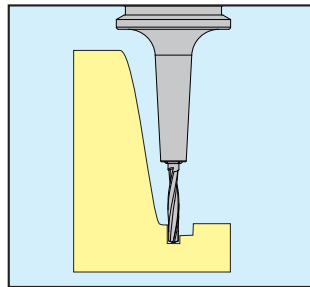

Maximum nose clearance

Features

- Maximum T.I.R. 0.0001" from taper to collet pocket
- Balanced to 25,000 RPM at G2.5
- Nose diameter only .55"
- Use with SlimFIT collets for shank sizes 3/32" – 1/4"



Collet Set

Part No.	Description
18743-12IMS	SlimFIT 6 - 12 pc. set

1/8" – 1/4" by 64ths (except no 5/32 or 7/32) 3mm – 6mm by 1mm

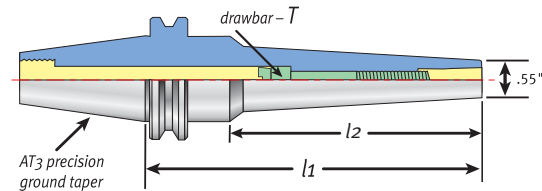

SlimFIT CAT40, CAT50 Toolholders

Part No.	Description	l1	l2	Drawbar-T
23654	CAT40 x SBL6 - 3" SlimFIT	3"	1.625"	SYIC-SBL-M6C-60
23656	CAT40 x SBL6 - 4" SlimFIT	4"	2.625"	SYIC-SBL-M6C-35
23658	CAT40 x SBL6 - 6" SlimFIT	6"	4.625"	SYIC-SBL-M6C-75
23659	CAT40 x SBL6 - 8" SlimFIT	8"	6.622"	SYIC-SBL-M6C-130
23672	CAT50 x SBL6-3.5" SlimFIT	3.5"	2.12"	SYIC-SBL-M6C-70
23676	CAT50 x SBL6-6" SlimFIT	6"	4.622"	SYIC-SBL-M6C-75



Features

- Use with any toolholder
- Extremely accurate drawbar collet
- Use with SlimFIT 6 collets

SlimFIT Extensions

Part No.	Description	L	l1	C
06032-3	1/2" x OLP6-3" extension	3"	1.89"	.50"
06032	1/2" x OLP6-5" extension	5"	1.89"	.50"
06034	1/2" x OLP6-6" extension	6"	1.89"	.50"
06038	5/8" x OLP6-5" extension	5"	1.89"	.625"
06040	5/8" x OLP6-6" extension	6"	1.89"	.625"
06042	5/8" x OLP6-8" extension	8"	1.89"	.625"

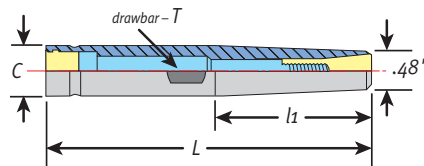

SlimFIT Inch Size Collets

Part No.	Description
18851-3/32	SlimFIT 6 - 3/32" collet
18851-7/64	SlimFIT 6 - 7/64" collet
18851-1/8	SlimFIT 6 - 1/8" collet
18851-9/64	SlimFIT 6 - 9/64" collet
18851-5/32	SlimFIT 6 - 5/32" collet
18851-11/64	SlimFIT 6 - 11/64" collet
18851-3/16	SlimFIT 6 - 3/16" collet
18851-13/64	SlimFIT 6 - 13/64" collet
18851-7/32	SlimFIT 6 - 7/32" collet
18851-15/64	SlimFIT 6 - 15/64" collet
18851-1/4	SlimFIT 6 - 1/4" collet

SlimFIT Metric Size Collets

Part No.	Description
18851-03	SlimFIT 6 - 3mm collet
18851-04	SlimFIT 6 - 4mm collet
18851-05	SlimFIT 6 - 5mm collet
18851-05.5	SlimFIT 6 - 5.5mm collet
18851-06	SlimFIT 6 - 6mm collet



Distributors – Call to register for our Distributors Webstore for full online access.

CAT50 Precision ER Toolholders



PowerCOAT nut is included with each holder.
Techniks Certified for accuracy and balance
Each holder comes with a complete lab report

Features

- *Balanced to 25,000 RPM at G2.5*
- *T.I.R. 0.0001" measured from taper to collet pocket*
- *PowerCOAT nut included for 75% more clamping power*



Collets
pg. 48



Nuts
pg. 62



Coolant
Rings
pg. 64



Retention
Knobs
pg. 200



Wrenches
pg. 204



Tightening
Stands
pg. 206

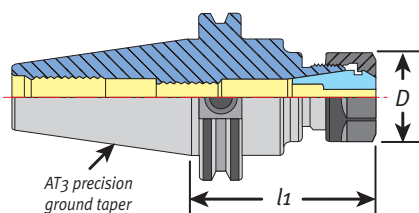

For ER16 and 20 slotted nuts, simply add SLOTNUT to the end of the part number. For holders with coolant nut included add -C to the end of the part number. Coolant nuts are not available for ER50.

CAT50 ER Toolholders

Part No.	Description	l1	D	Max. Shank	Stop Screw	Wrench
22281	CAT50 x ER16 - 4", hex nut	4"	1.08"	.406"	06083	04609
22285	CAT50 x ER16 - 6", hex nut	6"	1.08"	.406"	06083	04609
22287	CAT50 x ER16 - 8", hex nut	8"	1.08"	.406"	06083	04609
22291	CAT50 x ER20 - 4", hex nut	4"	1.34"	.512"	06087	04610
22293	CAT50 x ER20 - 6", hex nut	6"	1.34"	.512"	06087	04610
22295	CAT50 x ER20 - 8", hex nut	8"	1.34"	.512"	06087	04610
22303	CAT50 x ER25 - 4", slotted nut	4"	1.65"	.630"	06089	04615
22305	CAT50 x ER25 - 6", slotted nut	6"	1.65"	.630"	06089	04615
22307	CAT50 x ER25 - 8", slotted nut	8"	1.65"	.630"	06089	04615
22307-9	CAT50 x ER25 - 9", slotted nut	9"	1.65"	.630"	06089	04615
22311	CAT50 x ER32 - 4", slotted nut	4"	1.97"	.788"	06089	04616
22313	CAT50 x ER32 - 6", slotted nut	6"	1.97"	.788"	06089	04616
22317	CAT50 x ER32 - 8", slotted nut	8"	1.97"	.788"	06089	04616
22321	CAT50 x ER40 - 4", slotted nut	4"	2.48"	1.023"	06091	04617
22325	CAT50 x ER40 - 6", slotted nut	6"	2.48"	1.023"	06091	04617
22327	CAT50 x ER40 - 8", slotted nut	8"	2.48"	1.023"	06091	04617
22331	CAT50 x ER50 - 4", slotted nut	4"	3.07"	1.338"	06093	04618
22335	CAT50 x ER50 - 6", slotted nut	6"	3.07"	1.338"	06093	04618
22337	CAT50 x ER50 - 8", slotted nut	8"	3.07"	1.338"	06093	04618

CAT50 Precision CoolFLEX Toolholders



PowerCOAT nut is included with each holder.
Techniks Certified for accuracy and balance
Each holder comes with a complete lab report

Features

- Coolant-thru spindle or thru flange (DIN B)
- Balanced to 25,000 RPM at G2.5
- T.I.R. 0.0001" or better from taper to collet pocket

CoolFLEX Toolholders

CoolFLEX holders are factory set for coolant-thru spindle.
Simply remove 2 stop screws for DIN B coolant-thru flange.

Coolant Set Screws page 45.

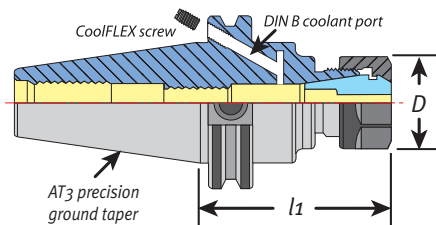

thru flange thru spindle

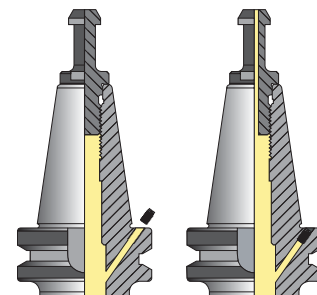

Replacement CoolFLEX Screws

Part No.	Description
HSA-6-6	50 taper DIN B screw

CAT50 CoolFLEX Coolant -Thru Spindle or Flange (DIN B)

Part No.	Description	l1	D	Max. Shank	Stop Screw	Wrench
22281F	CAT50 x ER16 - 4", hex nut	4"	1.08"	.406"	06083	04609
22285F	CAT50 x ER16 - 6", hex nut	6"	1.08"	.406"	06083	04609
22291F	CAT50 x ER20 - 4", hex nut	4"	1.34"	.512"	06087	04610
22293F	CAT50 x ER20 - 6", hex nut	6"	1.34"	.512"	06087	04610
22295F	CAT50 x ER20 - 8", hex nut	8"	1.34"	.512"	06087	04610
22303F	CAT50 x ER25 - 4", slotted nut	4"	1.65"	.630"	06089	04615
22311F	CAT50 x ER32 - 4", slotted nut	4"	1.97"	.788"	06089	04616
22313F	CAT50 x ER32 - 6", slotted nut	6"	1.97"	.788"	06089	04616
22317F	CAT50 x ER32 - 8", slotted nut	8"	1.97"	.788"	06089	04616
22321F	CAT50 x ER40 - 4", slotted nut	4"	2.48"	1.023"	06091	04617
22327F	CAT50 x ER40 - 8", slotted nut	8"	2.48"	1.023"	06091	04617



All Techniks products are backed by our 100% satisfaction guarantee!

CAT50 Precision ER Mini Nut Holders



PowerCOAT nut is included with each holder.
Techniks Certified for accuracy and balance
Each holder comes with a complete lab report

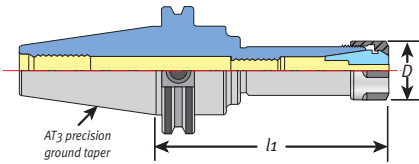

Features

- Narrow nut diameter for better clearance
- Balanced to 25,000 RPM at G2.5
- T.I.R. 0.0001" measured from taper to collet pocket



Collets
pg. 48



Nuts
pg. 62



Coolant
Rings
pg. 64



Retention
Knobs
pg. 200



Wrenches
pg. 204



Tightening
Stands
pg. 206



Coolant Options

- ER coolant rings (pg. 64)
- ER Steel Sealed collets (pg. 54)
- ER coolant collets (pg. 56)

CAT50 ER Mini Nut Holders

Part No.	Description	l1	D	Max. Shank	Stop Screw	Wrench
22364	CAT50 x ER16 - 4", mini nut	4"	.87"	.406"	06083	04622
22366	CAT50 x ER16 - 6", mini nut	6"	.87"	.406"	06083	04622
22368	CAT50 x ER20 - 4", mini nut	4"	1.102"	.512"	06087	04623
22370	CAT50 x ER20 - 6", mini nut	6"	1.102"	.512"	06087	04623

CAT50 Precision ER32 SuperRIGID Holders



Features

- *Balanced to 25,000 RPM at G2.5*
- *Best T.I.R. of any collet chuck*
- *Best Z axis clearance of any collet chuck*
- *SuperRIGID design is great for heavy side loads*



Collet nut is included with each holder.
Techniks Certified for accuracy and balance
Each holder comes with a complete lab report



Standard collet chuck



SuperRIGID collet chuck



Use SuperRIGID holders with ER32 collets.
For coolant applications use our ER32 Steel Sealed coolant collets (page 54).



Standard collet chucks have more than double the projection of SuperRIGID chucks.



Minimal projection maximizes rigidity. SuperRIGID holders are an ideal choice for high speed or high torque machining.

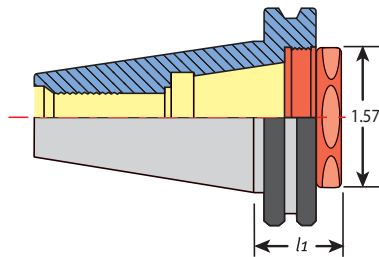

PowerCOAT Replacement Nut

CAT50 SuperRIGID ER Toolholders

Part No.	Description	I1	Collet	Max. Shank	Wrench
22311S	CAT50 x ER32	1.10"	ER32	3/4" or 20mm	894-36
TE-22HN	hex style nut				

CAT50 Precision ER DualDRIVE Toolholders



PowerCOAT nut is included with each holder.
Techniks Certified for accuracy and balance
Each holder comes with a complete lab report

Benefits

- Better rigidity and reduced vibration
- Improved performance at high metal removal rates and when machining at extended lengths
- Provides the benefits of dual-contact machining on standard spindles too!

CoolFLEX Feature

CoolFLEX holders are factory set for coolant-thru spindle. Simply remove 2 stop screws for DIN B coolant-thru flange.

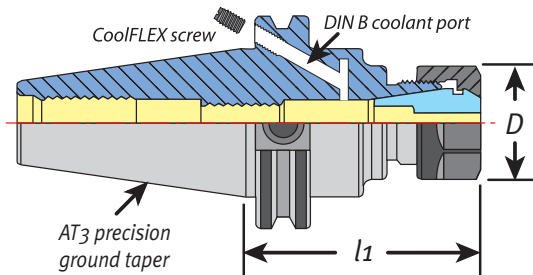

Coolant Set Screws page 45.

CAT50 ER DualDRIVE Coolant -Thru Spindle or Flange (DIN B)

Part No.	Description - l1	l1	D	Collet	Max. Shank	Set Screw	Wrench
72281	CAT50 x ER16 - 4" DualDRIVE	4"	1.08"	ER16	.406"	06083	04609
72285	CAT50 x ER16 - 6" DualDRIVE	6"	1.08"	ER16	.406"	06083	04609
72287	CAT50 x ER16 - 8" DualDRIVE	8"	1.08"	ER16	.406"	06083	04609
72311	CAT50 x ER32 - 4" DualDRIVE	4"	1.97"	ER32	.788"	06089	04616
72313	CAT50 x ER32 - 6" DualDRIVE	6"	1.97"	ER32	.788"	06089	04616
72317	CAT50 x ER32 - 8" DualDRIVE	8"	1.97"	ER32	.788"	06089	04616
72321	CAT50 x ER40 - 4" DualDRIVE	4"	2.48"	ER40	1.023"	06091	04617

Features

- Use with existing dual-contact spindles
- Coolant-thru spindle or thru flange (DIN B)
- Balanced to 25,000 RPM at G2.5

DualDRIVE For dual contact

Standard toolholder

1/8" gap between toolholder and spindle face allows holder to give under high side loads.

DualDRIVE toolholder

DualDRIVE eliminates the gap for increased rigidity and accuracy. Works with any CAT50 spindle.

US Patent 7393166B23

See an on machine demonstration video of DualDRIVE compared to standard toolholders at: www.techniksusa.com/videos2008/DD

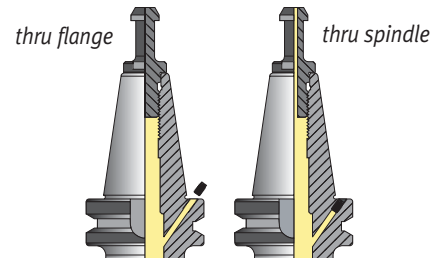

Replacement CoolFLEX Screws

Part No.	Description
HSA-6-6	50 taper DIN B screw

BT30 Precision ER Toolholders and Mini Nut Holders



PowerCOAT nut is included with each holder.
Techniks Certified for accuracy and balance.

Features

- Balanced to 25,000 RPM at G2.5
- T.I.R. 0.0001" measured from taper to collet pocket
- Taper ground to AT3 accuracy or better

NOTE: ER16 and 20 toolholders come with hex nut as standard.
For slotted nuts simply add SLOTNUT to the end of the part number.
For holders with coolant nut included add -C to the end of the part number.

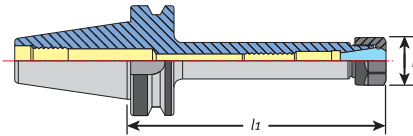

BT30 Precision ER Toolholders

Part No.	Description	l1	D	Max. Shank	Stop Screw	Wrench
16102	BT30 x ER16 - 60mm, hex nut	60mm	1.08"	.406"	06083	04609
16101	BT30 x ER16 - 70mm, hex nut	70mm	1.08"	.406"	06083	04609
16103	BT30 x ER16 - 90mm, hex nut	90mm	1.08"	.406"	06083	04609
16104	BT30 x ER16 - 100mm, hex nut	100mm	1.08"	.406"	06083	04609
16105	BT30 x ER16 - 120mm, hex nut	120mm	1.08"	.406"	06083	04609
16106	BT30 x ER20 - 70mm, hex nut	70mm	1.34"	.512"	06087	04610
16107	BT30 x ER20 - 135mm, hex nut	135mm	1.34"	.512"	06087	04610
16108-2.5	BT30 x ER20 - 63.5mm, hex nut	63.5mm	1.34"	.512"	06087	04610
16109	BT30 x ER25 - 70mm, slotted nut	70mm	1.65"	.63"	06089	04615
16110	BT30 x ER25 - 60mm, slotted nut	60mm	1.65"	.63"	06089	04615
16111-90	BT30 x ER25 - 90mm, slotted nut	90mm	1.65"	.63"	06089	04615
16111	BT30 x ER25 - 135mm, slotted nut	135mm	1.65"	.63"	06089	04615
16112	BT30 x ER32 - 60mm, slotted nut	60mm	1.97"	.788"	06089	04616
16113	BT30 x ER32 - 70mm, slotted nut	70mm	1.97"	.788"	06089	04616
16114	BT30 x ER32 - 100mm, slotted nut	100mm	1.97"	.788"	06089	04616
16115	BT30 x ER40 - 80mm, slotted nut	80mm	2.48"	1.023"	06091	04617



Features

- Narrow nut diameter for better clearance
- Balanced to 25,000 RPM at G2.5
- T.I.R. 0.0001" measured from taper to collet pocket



BT30 Precision ER Mini Nut Holders

For coolant applications use ER16 or ER20 coolant mini nut (pg. 63)

Part No.	Description	l1	D	Max. Shank	Stop Screw	Wrench
16302	BT30 x ER11 - 70mm, mini nut	70	.63"	.275"	06081	04621
16304	BT30 x ER11 - 100mm, mini nut	100mm	.63"	.275"	06081	04621
16308	BT30 x ER16 - 70mm, mini nut	70mm	.87"	.406"	06083	04622
16312	BT30 x ER16 - 120mm, mini nut	120mm	.87"	.406"	06083	04622
16313	BT30 x ER20 - 70mm, mini nut	70mm	1.34"	.512"	06087	04610
16314	BT30 x ER20 - 100mm, mini nut	100mm	1.102"	.512"	06087	04623
16318	BT30 x ER20 - 150mm, mini nut	150mm	1.102"	.512"	06087	04623

BT30 Precision ER DualDRIVE Toolholders



PowerCOAT nut is included with each holder.
Techniks Certified for accuracy and balance
Each holder comes with a complete lab report

Benefits

- Better rigidity and reduced vibration
- Improved performance at high metal removal rates and when machining at extended lengths
- Provides the benefits of dual-contact machining on standard spindles too!

See an on machine demonstration video of DualDRIVE compared to standard toolholders at: www.techniksusa.com/videos2008/DD

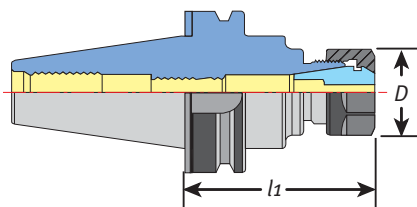

BT30 ER DualDRIVE Toolholders

Part No.	Description - l1	l1	D	Collet	Max. Shank	Set Screw	Wrench
66102	BT30 x ER16 - 60mm DualDRIVE	60mm	1.08"	ER16	.406"	06083	04609
66103	BT30 x ER16 - 90mm DualDRIVE	90mm	1.08"	ER16	.406"	06083	04609
66104-105	BT30 x ER16 - 105mm DualDRIVE	105mm	1.08"	ER16	.406"	06083	04609
66106-105	BT30 x ER20 - 105mm DualDRIVE	105mm	1.34"	ER20	.512"	06087	04610
66106-60	BT30 x ER20 - 60mm DualDRIVE	60mm	1.34"	ER20	.512"	06087	04610
66106-90	BT30 x ER20 - 90mm DualDRIVE	90mm	1.34"	ER20	.512"	06087	04610
66109-60	BT30 x ER25 - 60mm DualDRIVE	60mm	1.65"	ER25	.63"	06089	04615
66113-60	BT30 x ER32 - 60mm DualDRIVE	60mm	1.97"	ER32	.788"	06089	04616
66113-90	BT30 x ER32 - 90mm DualDRIVE	90mm	1.97"	ER32	.788"	06089	04616
66115	BT30 x ER40 - 80mm DualDRIVE	80mm	2.48"	ER40	1.023"	06091	04617

Features

- Use with existing dual-contact spindles
- Improves rigidity and reduces vibration
- Balanced to 25,000 RPM at G2.5

DualDRIVE For dual contact

Standard toolholder

1/8" gap between toolholder and spindle face allows holder to give under high side loads.

DualDRIVE toolholder

DualDRIVE eliminates the gap for increased rigidity and accuracy. Works with any BT30 spindle.

US Patent 7393166B23



Collets
pg. 48



Nuts
pg. 62



Coolant
Rings
pg. 64



Retention
Knobs
pg. 200



Wrenches
pg. 204



Tightening
Stands
pg. 206



Coolant Options

- ER coolant rings (pg. 64)
- ER Steel Sealed collets (pg. 54)
- ER coolant collets (pg. 56)

BT30 and BT40 Precision SlimFIT Toolholders



Features

- Maximum T.I.R. 0.0001" from taper to collet pocket
- Balanced to 25,000 RPM at G2.5
- Nose diameter only .55"
- Use with SlimFIT collets for shank sizes 3/32" – 1/4"



Internal drawbar collet eliminates need for clamping nut to permit narrow nose diameter. 4° collet provides greater holding power and improved accuracy.



Collet Set

Part No.	Description
18743-12IMS	SlimFIT 6 - 12 pc. set

1/8" – 1/4" by 64ths (except no 5/32 or 7/32) 3mm – 6mm by 1mm



Coolant-thru design

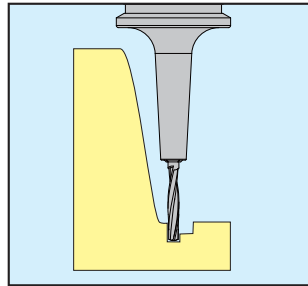

Maximum nose clearance

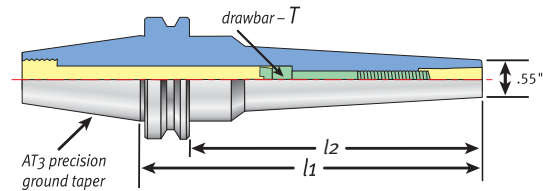

SlimFIT BT30, BT40 Toolholders

Part No.	Description	l1	l2	Drawbar
18854	BT30 x SBL6-70	70mm	48mm	SYIC-SBL-M6C-45
18856	BT30 x SBL6-100	100mm	78mm	SYIC-SBL-M6C-70
18866	BT40 x SBL6-70	70mm	43mm	SYIC-SBL-M6C-45
18868	BT40 x SBL6-100	100mm	73mm	SYIC-SBL-M6C-75
18868-150	BT40 x SBL6-150	150mm	123mm	SYIC-SBL-M6C-70
18869	BT40 x SBL6-200	200mm	173mm	SYIC-SBL-M6C-130



Features

- Use with any toolholder
- Extremely accurate drawbar collet
- Use with SlimFIT 6 collets

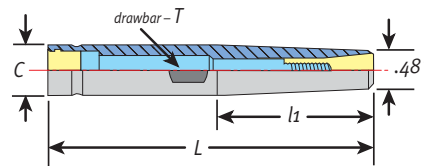

SlimFIT Extensions

Part No.	Description	L	l1	C
06032-3	1/2" x OLP6-3" extension	3"	1.89"	.50"
06032	1/2" x OLP6-5" extension	5"	1.89"	.50"
06034	1/2" x OLP6-6" extension	6"	1.89"	.50"
06038	5/8" x OLP6-5" extension	5"	1.89"	.625"
06040	5/8" x OLP6-6" extension	6"	1.89"	.625"
06042	5/8" x OLP6-8" extension	8"	1.89"	.625"

SlimFIT Inch Size Collets

Part No.	Description
18851-3/32	SlimFIT 6 - 3/32" collet
18851-7/64	SlimFIT 6 - 7/64" collet
18851-1/8	SlimFIT 6 - 1/8" collet
18851-9/64	SlimFIT 6 - 9/64" collet
18851-5/32	SlimFIT 6 - 5/32" collet
18851-11/64	SlimFIT 6 - 11/64" collet
18851-3/16	SlimFIT 6 - 3/16" collet
18851-13/64	SlimFIT 6 - 13/64" collet
18851-7/32	SlimFIT 6 - 7/32" collet
18851-15/64	SlimFIT 6 - 15/64" collet
18851-1/4	SlimFIT 6 - 1/4" collet

SlimFIT Metric Size Collets

Part No.	Description
18851-03	SlimFIT 6 - 3mm collet
18851-04	SlimFIT 6 - 4mm collet
18851-05	SlimFIT 6 - 5mm collet
18851-05.5	SlimFIT 6 - 5.5mm collet
18851-06	SlimFIT 6 - 6mm collet

BT40 Precision ER Toolholders



PowerCOAT nut is included with each holder.
Techniks Certified for accuracy and balance
Each holder comes with a complete lab report

Features

- *Balanced to 25,000 RPM at G2.5*
- *T.I.R. 0.0001" measured from taper to collet pocket*
- *PowerCOAT nut included for 75% more clamping power*



Coolant Options

- *ER coolant rings (pg. 64)*
- *ER Steel Sealed collets (pg. 54)*
- *ER coolant collets (pg. 56)*

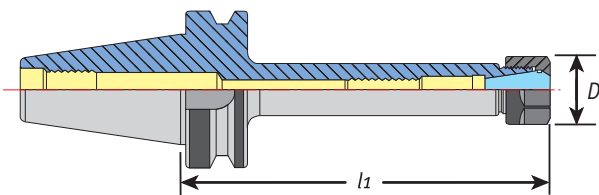

Collets
pg. 48



Nuts
pg. 62



Coolant
Rings
pg. 64



Retention
Knobs
pg. 200



Wrenches
pg. 204



Tightening
Stands
pg. 206

For ER16 and 20 slotted nuts, simply add **SLOTNUT** to the end of the part number. For holders with coolant nut included add **-C** to the end of the part number.

BT40 ER Toolholders

Part No.	Description	l1	D	Max. Shank	Stop Screw	Wrench
16151	BT40 x ER16 - 70mm, hex nut	70mm	1.08"	.406"	06083	04609
16153	BT40 x ER16 - 100mm, hex nut	100mm	1.08"	.406"	06083	04609
16155	BT40 x ER16 - 125mm, hex nut	125mm	1.08"	.406"	06083	04609
16157	BT40 x ER16 - 150mm, hex nut	150mm	1.08"	.406"	06083	04609
16158	BT40 x ER16 - 180mm, hex nut	180mm	1.08"	.406"	06083	04609
16159	BT40 x ER20 - 70mm, hex nut	70mm	1.34"	.512"	06085	04610
16162	BT40 x ER20 - 100mm, hex nut	100mm	1.34"	.512"	06085	04610
16165	BT40 x ER20 - 135mm, hex nut	135mm	1.34"	.512"	06085	04610
16167	BT40 x ER20 - 150mm, hex nut	150mm	1.34"	.512"	06085	04610
16169	BT40 x ER25 - 70mm, slotted nut	70mm	1.65"	.630"	06089	04615
16171	BT40 x ER25 - 100mm, slotted nut	100mm	1.65"	.630"	06089	04615
16175	BT40 x ER25 - 150mm, slotted nut	150mm	1.65"	.630"	06089	04615
16177	BT40 x ER32 - 70mm, slotted nut	70mm	1.97"	.788"	06089	04616
16179	BT40 x ER32 - 100mm, slotted nut	100mm	1.97"	.788"	06089	04616
16181	BT40 x ER32 - 150mm, slotted nut	150mm	1.97"	.788"	06089	04616
16183	BT40 x ER40 - 80mm, slotted nut	80mm	2.48"	1.023"	06089	04617
16185	BT40 x ER40, 100mm, slotted nut	100mm	2.48"	1.023"	06089	04617
16189	BT40 x ER40 - 150mm, slotted nut	150mm	2.48"	1.023"	06089	04617

BT40 Precision ER CoolFLEX Toolholders



PowerCOAT nut is included with each holder.
Techniks Certified for accuracy and balance
Each holder comes with a complete lab report

Features

- Coolant-thru spindle or thru flange (DIN B)
- Balanced to 25,000 RPM at G2.5
- T.I.R. 0.0001" or better from taper to collet pocket



Collets
pg. 48



Nuts
pg. 62



Coolant
Rings
pg. 64



Retention
Knobs
pg. 200



Wrenches
pg. 204



Tightening
Stands
pg. 206

CoolFLEX Feature

CoolFLEX holders are factory set for coolant-thru spindle.
Simply remove 2 stop screws for DIN B coolant-thru flange.

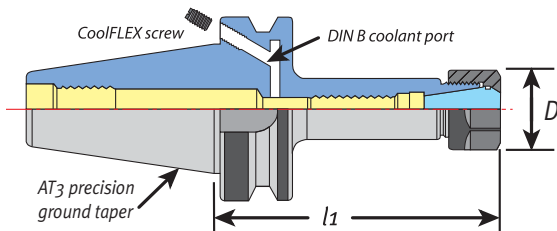

Coolant Set Screws page 45.

thru flange thru spindle

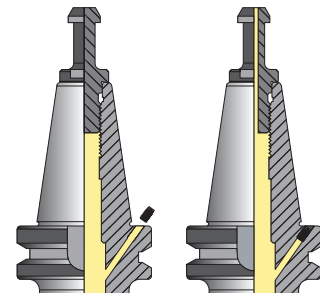

Replacement CoolFLEX Screws

Part No.	Description
HSA-4-6	40 taper DIN B screw

For ER16, and 20 slotted nuts, simply add SLOTNUT to the end of the part number. For holders with coolant nut included add -C to the end of the part number.

BT40 CoolFLEX Coolant -Thru Spindle or Flange (DIN B)

Part No.	Description	l1	D	Max. Shank	Stop Screw	Wrench
16151F	BT40 x ER16 - 70mm, hex nut, CoolFLEX	70mm	1.08"	.406"	06083	04609
16153F	BT40 x ER16 - 100mm, hex nut, CoolFLEX	100mm	1.08"	.406"	06083	04609
16157F	BT40 x ER16 - 150mm, hex nut, CoolFLEX	150mm	1.08"	.406"	06083	04609
16159F	BT40 x ER20 - 70mm, hex nut, CoolFLEX	70mm	1.34"	.512"	06085	04610
16162F	BT40 x ER20 - 100mm, hex nut, CoolFLEX	100mm	1.34"	.512"	06085	04610
16167F	BT40 x ER20 - 150mm, hex nut, CoolFLEX	150mm	1.34"	.512"	06085	04610
16177F	BT40 x ER32 - 70mm, slotted, CoolFLEX	70mm	1.97"	.788"	06089	04616
16181F	BT40 x ER32 - 150mm, slotted, CoolFLEX	150mm	1.97"	.788"	06089	04616



All Techniks products are backed by our 100% satisfaction guarantee!

BT40 Precision ER Mini Nut Holders



Features

- *Balanced to 25,000 RPM at G2.5*
- *T.I.R. 0.0001" measured from taper to collet pocket*
- *Taper ground to AT3 accuracy or better*



PowerCOAT nut is included with each holder.
Techniks Certified for accuracy and balance
Each holder comes with a complete lab report



See page 63 for replacement Mini Nuts.



Collets
pg. 48



Nuts
pg. 62



Coolant
Rings
pg. 64



Retention
Knobs
pg. 200



Wrenches
pg. 204



Tightening
Stands
pg. 206



Coolant Options

- *ER coolant rings (pg. 64)*
- *ER Steel Sealed collets (pg. 54)*
- *ER coolant collets (pg. 56)*

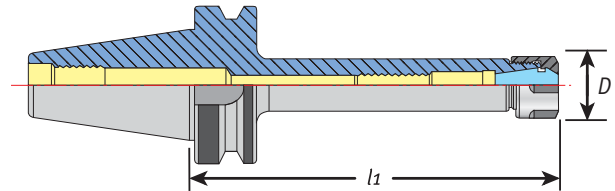

BT30, BT40 ER Mini Nut Holders

Part No.	Description	l1	D	Max. Shank	Stop Screw	Wrench
16321	BT40 x ER11 - 70mm, mini nut	70mm	16mm	.275"	06081	04621
16324	BT40 x ER11 - 150mm, mini nut	150mm	16mm	.275"	06081	04621
16325	BT40 x ER16 - 70mm, mini nut	70mm	22mm	.406"	06083	04622
16328	BT40 x ER16 - 150mm, mini nut	150mm	22mm	.406"	06083	04622
16328-200	BT40 x ER16 - 200mm, mini nut	200mm	22mm	.406"	06083	04622
16329	BT40 x ER20 - 70mm, mini nut	70mm	28mm	.512"	06087	04623
16330	BT40 x ER20 - 100mm, mini nut	100mm	28mm	.512"	06087	04623
16332	BT40 x ER20 - 150mm, mini nut	150mm	28mm	.512"	06087	04623

BT40 Precision SuperRIGID Holders



Collet nut is included with each holder.
Techniks Certified for accuracy and balance
Each holder comes with a complete lab report

Features

- Balanced to 25,000 RPM at G2.5
- Best T.I.R. of any collet chuck
- Best Z axis clearance of any collet chuck
- SuperRIGID design is great for heavy side loads



Standard collet chuck



SuperRIGID collet chuck



Use SuperRIGID holders with ER32 collets.
For coolant applications use our ER32 Steel Sealed coolant collets (page 54).



Standard collet chucks have more than double the projection of SuperRIGID chucks.



Minimal projection maximizes rigidity. SuperRIGID holders are an ideal choice for high speed or high torque machining.

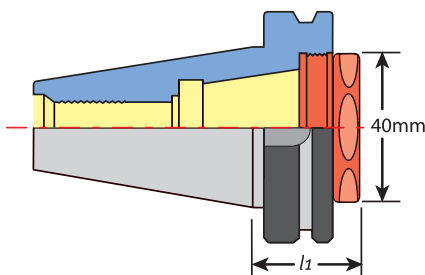

PowerCOAT Replacement Nut

BT40 SuperRIGID ER Toolholders

Part No.	Description	l1	Collet	Max. Shank	Wrench
16177S	BT40 x ER32 - 36mm	36mm	ER32	3/4" or 20mm	894-36
TE-22HN	hex style nut				

BT50 Precision ER Toolholders



PowerCOAT nut is included with each holder.
Techniks Certified for accuracy and balance
Each holder comes with a complete lab report

Features

- *Balanced to 25,000 RPM at G2.5*
- *T.I.R. 0.0001" measured from taper to collet pocket*
- *PowerCOAT nut included for 75% more clamping power*



Coolant Options

- *ER coolant rings (pg. 64)*
- *ER Steel Sealed collets (pg. 54)*
- *ER coolant collets (pg. 56)*

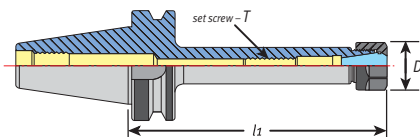

Collets
pg. 48



Nuts
pg. 62



Coolant
Rings
pg. 64



Retention
Knobs
pg. 200



Wrenches
pg. 204



Tightening
Stands
pg. 206

For ER16, and 20 slotted nuts, simply add **SLOTNUT** to the end of the part number. For holders with coolant nut included add **-C** to the end of the part number. Coolant nuts are not available for ER50.

BT50 Precision Toolholders

Part No.	Description	l1	D	Max. Shank	Stop Screw	Wrench
16251	BT50 x ER16 - 70mm, hex nut	70mm	1.08"	.406"	06083	04609
16252	BT50 x ER16 - 90mm, hex nut	90mm	1.08"	.406"	06083	04609
16253	BT50 x ER16 - 105mm, hex nut	105mm	1.08"	.406"	06083	04609
16254	BT50 x ER16 - 135mm, hex nut	135mm	1.08"	.406"	06083	04609
16255	BT50 x ER16 - 150mm, hex nut	150mm	1.08"	.406"	06083	04609
16263	BT50 x ER20 - 90mm, hex nut	90mm	1.34"	.512"	06087	04610
16265	BT50 x ER20 - 105mm, hex nut	105mm	1.34"	.512"	06087	04610
16267	BT50 x ER20 - 135mm, hex nut	135mm	1.34"	.512"	06087	04610
16271	BT50 x ER20 - 165mm, hex nut	165mm	1.34"	.512"	06087	04610
16275	BT50 x ER25 - 105mm, slotted nut	105mm	1.65"	.630"	06089	04615
16277	BT50 x ER25 - 135mm, slotted nut	135mm	1.65"	.630"	06089	04615
16279	BT50 x ER25 - 165mm, slotted nut	165mm	1.65"	.630"	06089	04615
16281	BT50 x ER32 - 80mm, slotted nut	80mm	1.97"	.788"	06089	04616
16283	BT50 x ER32 - 120mm, slotted nut	120mm	1.97"	.788"	06089	04616
16284	BT50 x ER32 - 150mm, slotted nut	150mm	1.97"	.788"	06089	04616
16285	BT50 x ER40 - 80mm, slotted nut	80mm	2.48"	1.023"	06091	04617
16289	BT50 x ER40 - 135mm, slotted nut	135mm	2.48"	1.023"	06091	04617
06291	BT50 x ER50 - 90mm, slotted nut	90mm	3.07"	1.338"	06093	04618

HSK32A, 40A, 50A, 63A, 100A Precision ER Toolholders



Techniks Certified for accuracy and balance
Each holder comes with a complete lab report

For ER11, 16 and 20 slotted nuts, simply add SLOTNUT to the end of the part number. For holders with coolant nut included add -C to the end of the part number. Coolant nuts not available for ER11.

Features

- Balanced to 25,000 RPM at G2.5
- T.I.R. 0.0001" measured from taper to collet pocket
- PowerCOAT nut included for 75% more clamping power

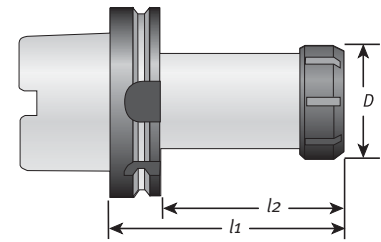

HSK32A, 40A, 50A, 63A, 100A Toolholders

Part No.	Description	l1	l2	D	Wrench
31278	HSK32A x ER20 - 80mm, slotted nut	80mm	60mm	34mm	04614
31284	HSK32A x ER25 - 80mm, mini nut	80mm	60mm	35mm	04624
31374	HSK40A x ER11 - 80mm, mini nut	80mm	60mm	16mm	04621
31376	HSK40A x ER16 - 80mm, hex nut	80mm	54mm	28mm	04609
31384	HSK40A x ER25 - 80mm, slotted nut	80mm	60mm	35mm	04624
31385	HSK40A x ER32 - 80mm, slotted nut	80mm	60mm	50mm	04616
31420	HSK50A x ER32 - 100mm, slotted nut	100mm	74mm	50mm	04616
31432	HSK63A x ER16 - 80mm, hex nut	80mm	54mm	28mm	04609
31434	HSK63A x ER16 - 100mm, hex nut	100mm	74mm	28mm	04609
31438	HSK63A x ER16 - 160mm, hex nut	160mm	134mm	28mm	04609
31446	HSK63A x ER20 - 160mm, hex nut	160mm	134mm	34mm	04610
31462	HSK63A x ER32 - 100mm, slotted nut	100mm	74mm	50mm	04616
31468	HSK63A x ER40 - 80mm, slotted nut	80mm	54mm	63mm	04617
31472	HSK63A x ER40 - 120mm, slotted nut	120mm	94mm	63mm	04617
31484	HSK100A x ER16 - 100mm, hex nut	100mm	74mm	28mm	04609
31486	HSK100A x ER16 - 160mm, hex nut	160mm	134mm	28mm	04609
31498	HSK100A x ER32 - 100mm, slotted nut	100mm	71mm	50mm	04616
31503	HSK100A x ER32 - 160mm, slotted nut	160mm	134mm	50mm	04616
31506	HSK100A x ER40 - 120mm, slotted nut	120mm	91mm	63mm	04617

HSKA Coolant Pipe and Wrench

Part No.	Description	HSK-A	D	T	Wrench
92002	Coolant Pipe	40	8mm	M12 x 1	91.11.026.002
92003	Coolant Pipe	50	10mm	M16 x 1	92.11.026.003
92004	Coolant Pipe	63	12mm	M18 x 1	93.11.026.004
92005	Coolant Pipe	100	16mm	M24 x 1.5	95.11.026.005

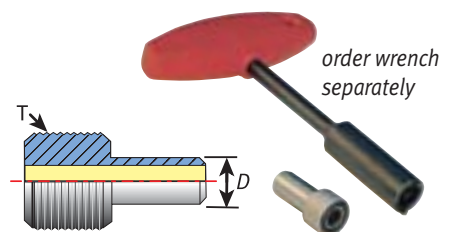

HSK63A Precision SlimFIT Toolholders



Internal drawbar collet eliminates need for clamping nut to permit narrow nose diameter. 4° collet provides greater holding power and improved accuracy.



Coolant-thru design

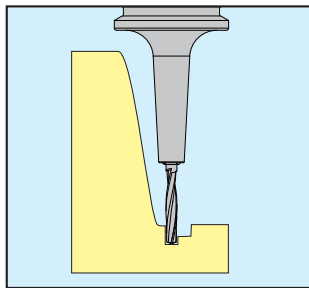

Maximum nose clearance

Features

- Maximum T.I.R. 0.0001" from taper to collet pocket
- Balanced to 25,000 RPM at G2.5
- Nose diameter only .55"
- Use with SlimFIT collets for shank sizes 3/32" – 1/4"



Collet Set

Part No.	Description
18743-12IMS	SlimFIT 6 - 12 pc. set

1/8" – 1/4" by 64ths (except no 5/32 or 7/32) 3mm – 6mm by 1mm

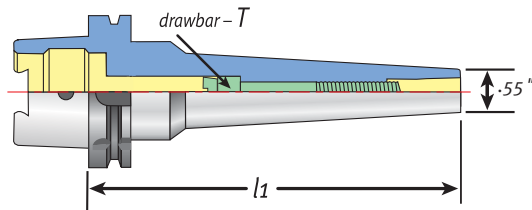

SlimFIT HSK63A Toolholders

Part No.	Description	l1	l2	Drawbar
35470	HSK63A x SBL6-80 SlimFIT	80mm	54mm	SYIC-SBL-M6C-15
35472	HSK63A x SBL6-120 SlimFIT	120mm	94mm	SYIC-SBL-M6C-50



Features

- Use with any toolholder
- Extremely accurate drawbar collet
- Use with SlimFIT 6 collets

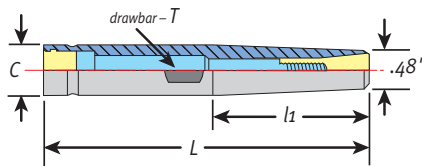

SlimFIT Extensions

Part No.	Description	L	l1	C
06032-3	1/2" x OLP6-3" extension	3"	1.89"	.50"
06032	1/2" x OLP6-5" extension	5"	1.89"	.50"
06034	1/2" x OLP6-6" extension	6"	1.89"	.50"
06038	5/8" x OLP6-5" extension	5"	1.89"	.625"
06040	5/8" x OLP6-6" extension	6"	1.89"	.625"
06042	5/8" x OLP6-8" extension	8"	1.89"	.625"

SlimFIT Inch Size Collets

Part No.	Description
18851-3/32	SlimFIT 6 - 3/32" collet
18851-7/64	SlimFIT 6 - 7/64" collet
18851-1/8	SlimFIT 6 - 1/8" collet
18851-9/64	SlimFIT 6 - 9/64" collet
18851-5/32	SlimFIT 6 - 5/32" collet
18851-11/64	SlimFIT 6 - 11/64" collet
18851-3/16	SlimFIT 6 - 3/16" collet
18851-13/64	SlimFIT 6 - 13/64" collet
18851-7/32	SlimFIT 6 - 7/32" collet
18851-15/64	SlimFIT 6 - 15/64" collet
18851-1/4	SlimFIT 6 - 1/4" collet

SlimFIT Metric Size Collets

Part No.	Description
18851-03	SlimFIT 6 - 3mm collet
18851-04	SlimFIT 6 - 4mm collet
18851-05	SlimFIT 6 - 5mm collet
18851-05.5	SlimFIT 6 - 5.5mm collet
18851-06	SlimFIT 6 - 6mm collet

ISO and SK Precision CNC Router Toolholders



Techniks Certified for accuracy and balance
Each holder comes with a complete lab report

Features

- *Balanced to 40,000 RPM at G2.5*
- *T.I.R. 0.0001" or better from taper to collet pocket*
- *PowerCOAT nut and retention knob included*

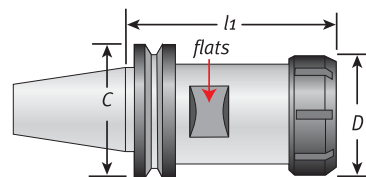

ISO 20 and ISO 25 Toolholders for CNC Routers

Part No.	Description	l1	C	D	Nut	Wrench	Flats
16000-2016MC	*ISO 20 x ER16 - 52mm, HS mini nut & pull stud	52mm	30mm	22mm	53116	04622	17
16000-2516	ISO 20 x ER16 - 52mm, slotted nut & pull stud	52mm	30mm	32mm	46116	04613	17
16000-2520	ISO 20 x ER20 - 52mm, slotted nut & pull stud	52mm	30mm	35mm	46120	04614	17
12194-IS025	ISO 25 x ER25 - 50mm, slotted nut & pull stud	50mm	38mm	42mm	46125	04615	27
25077	ISO 25 x ER25 - 65mm, slotted nut & pull stud	65mm	38mm	42mm	23111	04615	27

*Balanced to 40,000 RPM. Use for Haas OM-1A, OM-2A Office Mills. Haas is trademark of Haas Automation and used here for identification only.



Features

- *Balanced to 25,000 RPM at G2.5*
- *T.I.R. 0.0001" or better from taper to collet pocket*
- *PowerCOAT nut included for 75% more clamping power*

Taper ground to AT3 accuracy or better
Techniks Certified for accuracy and balance

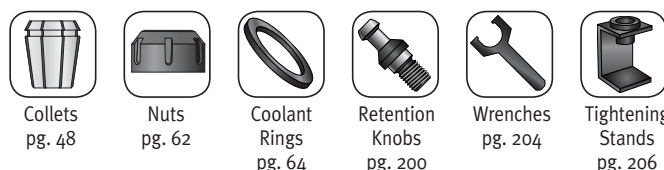

Collets
pg. 48

Nuts
pg. 62

Coolant
Rings
pg. 64

Retention
Knobs
pg. 200

Wrenches
pg. 204

Tightening
Stands
pg. 206

ISO 30 and SK 30 Toolholders for CNC Routers

Part No.	Description	l1	C	D	Nut	Wrench	Flats
42407-W	ISO 30 x ER11 - 100mm, mini nut	100mm	50mm	16mm	23111	04621	14
42213-W-50	ISO 30 x ER32 - 50mm, slotted nut	50mm	50mm	50mm	46132	04616	47
42213-W-63	ISO 30 x ER32 - 63mm, slotted nut	63mm	50mm	50mm	46132	04616	36
42213-W-90	ISO 30 x ER32 - 90mm, slotted nut	90mm	50mm	50mm	46132	04616	36
12000-CMS	ISO 30 x ER32 - CMS toolholder	58mm	46mm	50mm	46132	04616	36
12040-CMS	ISO 30 x ER40 - CMS toolholder	66mm	46mm	63mm	46140	04617	42
42215-W-57	ISO 30 x ER40 - 57mm, slotted nut	57mm	50mm	63mm	46140	04617	47
42261-W	ISO 40 x ER40 - 70mm, slotted nut	70mm	63.55mm	63mm	46140	04617	46
NT-54300130	SK-30 x SYOZ 25 toolholder	63mm	50mm	60mm	83632	03691	38



Distributors - Call to register for our Distributors Webstore for full online access.

BT30 and BT 35 Precision CNC Router Toolholders



PowerCOAT nut is included with each holder.
Techniks Certified for accuracy and balance
Each holder comes with a complete lab report

Features

- Balanced to 25,000 RPM at G2.5
- T.I.R. 0.0001" measured from taper to collet pocket
- PowerCOAT nut included for 75% more clamping power



Collets
pg. 48



Nuts
pg. 62



Coolant
Rings
pg. 64



Retention
Knobs
pg. 200



Wrenches
pg. 204



Tightening
Stands
pg. 206

Don't see what you are looking for? See page 29 for the rest of our BT30 collet chucks, or you can request a special order if needed.

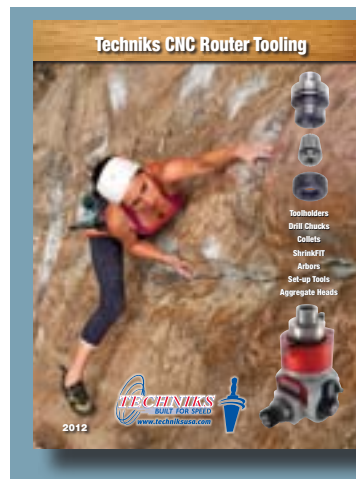
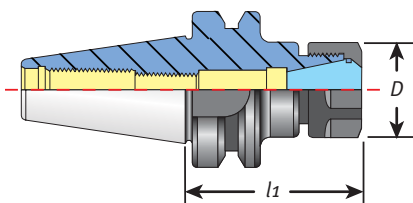

Scan the QR code with a smartphone or enter this url: http://delivr.com/1ioe6_qr to request our new 76 page CNC Router Tooling catalog. Or, you can call us at (800) 597-3921 to have it sent to you.



BT30, ER Toolholders

Part No.	Description	l1	D	Collet Nut	Stop Screw	Wrench
16106-W	BT30 x ER20 - 70 without slots	70mm	34mm	41120	06087	04614
16121	BT30 x ER32 - 60, 41mm flats - Komo	60mm	50mm	46132	06089	04616
16131	BT30 x ER32 - 90 38mm flats - Komo	90mm	50mm	46132	06089	04616

BT30, SYOZ 25 Toolholders

Part No.	Description	l1	D	Collet Nut	Wrench
16001-W	BT30 x SYOZ 25 - 70, 38mm flats	70mm	60mm	83632	03691
16001	BT30 x SYOZ 25 - 70 with nut	70mm	60mm	83632	03691

BT 35, ER32, SYOZ 25 Toolholders for Heian Routers

Part No.	Description	l1	D	Collet Nut	Wrench
16010	BT 35 x SYOZ 25 - 76 with nut	76mm	60mm	83632	03691
161-BT35-ER32 76	BT 35 x ER32 - 76	76mm	50mm	46132	04616

HSK E and HSK F Precision CNC Router Toolholders



Techniks Certified for accuracy and balance

Features

- Balanced to 25,000 RPM at G2.5
- T.I.R. 0.0001" measured from taper to collet pocket
- PowerCOAT nut included for 75% more clamping power

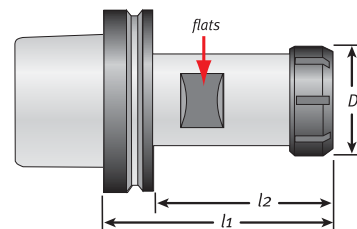

HSK32E, 40E, 50E, 63E Toolholders for HSK E Type Spindle

Part No.	Description	l1	l2	D	Nut	Stop Screw	Wrench	Flats
31374-60-E	HSK32E x ER25 - 60mm, slotted nut	60mm	27mm	42mm	46125	06089	04615	22mm
31376-E	HSK40E x ER16 - 65mm, slotted nut	65mm	45mm	32mm	46116	06083	04613	24mm
31383-E	HSK40E x ER25 - 75mm, slotted nut	75mm	55mm	42mm	46125	06089	04615	27mm
31386-E	HSK40E x ER32 - 100mm, slotted nut	100mm	80mm	50mm	46132	06089	04616	35mm
31402-E	HSK50E x ER16 - 80mm, slotted nut	80mm	60mm	28mm	46116	06083	04613	27mm
31419-E	HSK50E x ER32 - 85mm, slotted nut	85mm	59mm	50mm	46132	06089	04616	36mm
31456-E	HSK63E x ER32 - 90mm, slotted nut	90mm	64mm	50mm	46132	06089	04616	36mm
31472-E	HSK63E x ER40 - 120mm, slotted nut	120mm	94mm	63mm	46140	06091	04617	46mm
50001	HSK63E x ER40 -75mm, slotted nut	75mm	49mm	63mm	46140	06091	04617	46mm



Features

- Balanced to 25,000 RPM at G2.5
- T.I.R. 0.0001" or better from taper to collet pocket

PowerCOAT nut is included with each holder.
Techniks Certified for accuracy and balance
Each holder comes with a complete lab report

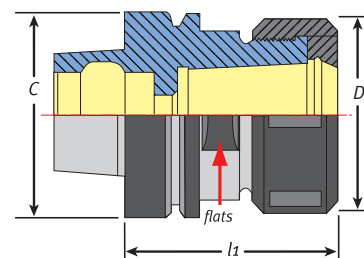

HSK50F, 63F Toolholders for CNC Routers

Part No.	Description	l1	D	Nut	Wrench	Flats
31419-F	HSK50F x ER32 - 80mm, slotted nut	80mm	50mm	46132	04616	36mm
31431-F	HSK63F x ER16 - 60mm, slotted nut	60mm	32mm	46116	04613	26mm
31434-F	HSK63F x ER16 - 100mm, slotted nut	100mm	32mm	46116	04613	26mm
30000	HSK63F x ER32 - 70mm, slotted nut	70mm	50mm	46132	04616	36mm
30001	HSK63F x ER40 - 76mm, slotted nut	76mm	63mm	46140	04617	46mm
30001-L	HSK63F x ER40 - 75mm, left-hand thread	75mm	63mm	46140-L	04617	46mm
30002	HSK63F x ER40 - 90mm, slotted nut	90mm	63mm	46140	04617	46mm
30003	HSK63F x ER40 - 115mm, slotted nut	115mm	63mm	46140	04617	46mm
30005	HSK63F x ER40 - 125mm, slotted nut	125mm	63mm	46140	04617	46mm
31025F	HSK63 F x SYOZ 25 - 80mm, slotted nut	80mm	60mm	83632	03691	38mm

Precision ER Mini-Nut and Straight Shank Extensions



Features

- Collet pocket T.I.R. 0.0001"
 - All surfaces precision ground
- Extension length should not exceed a 4 : 1 ratio of length to diameter. For example, a 1/2" shank should not extend more than 2" in front of the holder.

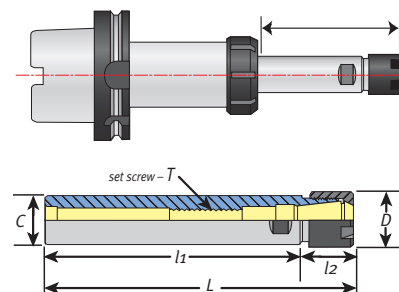

Mini-Nut ER Straight Shank Extensions

Part No.	Description	C	L	l1	l2	D	Stop Screw	Wrench
04889	3/8" x ER8, - 100mm	3/8"	124mm	100mm	24mm	12mm	-	04620
04891	1/2" x ER11, - 140mm	1/2"	166.5mm	140mm	26.5mm	16mm	-	04621
04893	5/8" x ER11, - 140mm	5/8"	158.5mm	140mm	18.5mm	16mm	-	04621
04895	1/2" x ER16, - 140mm	1/2"	177mm	140mm	37mm	22mm	-	04622
04896	3/4" x ER16, - 140mm	3/4"	165mm	140mm	25mm	22mm	06083	04622
04892	1/2" x ER20, - 140mm	1/2"	180mm	140mm	40mm	28mm	06083	04623
04894	3/4" x ER20, - 140mm	3/4"	180mm	140mm	40mm	28mm	06083	04623
04881	20mm x ER20, - 180mm	20mm	220mm	180mm	40mm	28mm	06083	04623
04897	1.0" x ER20, - 140mm	1.0"	168mm	140mm	28mm	28mm	06083	04623
04898	3/4" x ER25, - 100mm	3/4"	149mm	100mm	49mm	35mm	06087	04624
04888	1.0" x ER25, - 140mm	1.0"	190mm	140mm	50mm	35mm	06083	04624



Features

- Collet pocket T.I.R. 0.0001"
- All surfaces precision ground

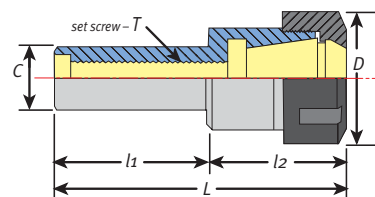

ER Straight Shank Extensions

Part No.	Description	C	L	l1	l2	D	Stop Screw	Wrench
04851	16mm x ER11, - 140mm, hex nut	16mm	174.5mm	140mm	21.6mm	19mm	-	04608
04855	1/2" x ER11, - 140mm, hex nut	1/2"	174.5mm	140mm	21.6mm	19mm	-	04608
04854	5/8" x ER11, - 140mm, hex nut	5/8"	174.5mm	140mm	21.6mm	19mm	-	04608
04832	5/8" x ER16, - 60mm, hex nut	5/8"	95.1mm	60mm	35.1mm	28mm	-	04609
04834	3/4" x ER16, - 50mm, hex nut	3/4"	85.1mm	50mm	35.1mm	28mm	06083	04609
04835	3/4" x ER16, - 100mm, hex nut	3/4"	135.1mm	100mm	35.1mm	28mm	06083	04609
04856	3/4" x ER16, - 140mm, hex nut	3/4"	175.1mm	140mm	35.1mm	28mm	06083	04609
04836-2.5	3/4" x ER20, - 2-1/2", hex nut	3/4"	100mm	2-1/2"	38mm	34mm	06083	04610
04858	1.0" x ER20, - 140mm, hex nut	1.0"	180.5mm	140mm	40.5mm	34mm	06083	04610
04837	1.0" x ER25, - 50mm, slotted nut	1.0"	101mm	50mm	51mm	42mm	06089	04615
04817	20mm x ER32, - 50mm, slotted nut	20mm	97.1mm	50mm	47mm	50mm	06089	04616
04818	20mm x ER32, - 100mm, slotted nut	20mm	146.5mm	100mm	47mm	50mm	06083	04616
04839	1.0" x ER32, - 50mm, slotted nut	1.0"	101.5mm	50mm	51.5mm	50mm	06089	04616
04839-140	1.0" x ER32, - 140mm, slotted nut	1.0"	191.5mm	140mm	51.5mm	50mm	06083	04616
04843	1-1/4" x ER32, - 60mm, slotted nut	1-1/4"	111.5mm	60mm	51.5mm	50mm	06089	04616
04841	1.0" x ER40, - 50mm, slotted nut	1.0"	115mm	50mm	65mm	63mm	06083	04617

Precision ER Coolant-Thru Shanks and ER Double Ended



No. 04805-C

Features

- For coolant up to 1,500 PSI
- Collet pocket T.I.R. 0.0001"
- PowerCOAT coolant nut included

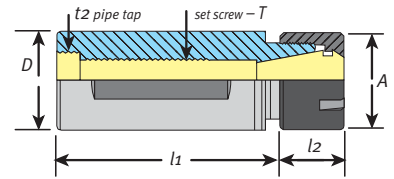

Use with Black Gold ER coolant rings for coolant-thru 04808C available with 1/8" NPT side entry coolant. Mini Coolant nuts page 63. Coolant-thru-tool set screws page 45.

Coolant-Thru Straight Shank Extensions

Part No.	Description	l1	l2	D	T	t2	A	Wrench
04802-C	3/4" x ER16, - 2" shank, coolant mini nut	1.65"	.916"	3/4"	m10 x 1.5	1/4" NPT	22mm	04622
04803-C	3/4" x ER16, - 3" shank, coolant mini nut	2.44"	.916"	3/4"	m10 x 1.5	1/4" NPT	22mm	04622
04804-C	3/4" x ER16, - 4" shank, coolant mini nut	3.42"	.916"	3/4"	m10 x 1.5	1/4" NPT	22mm	04622
04805-C	1.0" x ER20, - 3" shank, coolant mini nut	2.01"	1.07"	1.0"	m12 x 1.75	3/8" NPT	1.10"	04623
04806-C	1.0" x ER20, - 4" shank, coolant mini nut	3.31"	1.07"	1.0"	m12 x 1.75	3/8" NPT	1.10"	04623
04808-C	1.25" x ER32, - 2.36" shank, slotted nut	2.36"	2.16"	1-1/4"	m12 x 1.75	3/8" NPT	1.97"	04616



O-ring seals coolant

Features

- For coolant up to 1,500 PSI
- Collet pocket T.I.R. 0.0001"
- PowerCOAT coolant nut included

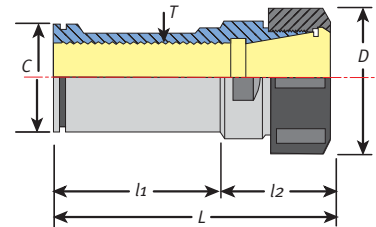

This ER collet chuck fits CNC lathes and can also be used for tapping applications. It seals coolant from the turret to the shank with an o-ring on the end of the shank.

CNC Lathe Coolant-thru Straight Shanks

Part No.	Description	C	l1	L	l2	D	T	Wrench
04782	1-1/4" x ER25, - 60mm shank	1-1/4"	60mm	97mm	37mm	42mm	M18 x 1.5	04615
04784	1-1/4" x ER32, - 60mm shank	1-1/4"	60mm	103mm	43mm	50mm	M22 x 1.5	04616
04788	1-1/2" x ER32, - 80mm shank	1-1/2"	80mm	118mm	38mm	50mm	M22 x 1.5	04616
04786	1-1/4" x ER40, - 60mm shank	1-1/4"	60mm	120mm	60mm	63mm	M28 x 1.5	04617
04790	1-1/2" x ER40, - 75mm shank	1-1/2"	75mm	135mm	60mm	63mm	M28 x 1.5	04617



Features

- Collet pocket T.I.R. 0.0001"
- Wrench flats extend full length of shank

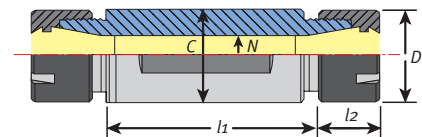

Double-Ended Straight Shank for CNC Swiss Machines

Part No.	Description	C	D	L1	L2	N	Wrench
04801-DE	3/4" x ER11, - 2.5" shank, double ended mini nut	3/4"	16mm	44mm	12mm	8mm	04621
04802-DE	3/4" x ER11, - 3.35" shank, double ended mini nut	3/4"	16mm	65mm	12mm	8mm	04621
04803-DE	3/4" x ER11, - 4.0" shank, double ended mini nut	3/4"	16mm	77mm	12mm	8mm	04621
04804-DE	3/4" x ER11, - 5.0" shank, double ended mini nut	3/4"	16mm	99.5mm	12mm	8mm	04621

TG75 and TG100 Precision Toolholders



Techniks Certified for accuracy and balance
Each holder comes with a complete lab report

Features

- Balanced to 25,000 RPM at G2.5
- T.I.R. 0.0001" measured from taper to collet pocket
- PowerCOAT nut included for 75% more clamping power

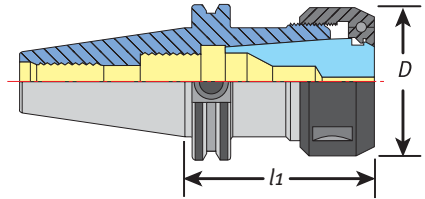

TG75 and TG100 Precision Toolholders

Part No.	Description	l1	D	Collet Range	Stop Screw	Wrench
23008	CAT40 x TG75 - 2.75"	2.75"	1.88"	.094 - .750"	06089	04616
23014	CAT40 x TG100 - 3"	3"	2.362"	.094 - 1.0"	06093	03691
23016	CAT40 x TG100 - 4"	4"	2.362"	.094 - 1.0"	06093	03691
23018	CAT40 x TG100 - 6"	6"	2.362"	.094 - 1.0"	06093	03691
23030	CAT50 x TG100 - 3"	3"	2.362"	.094 - 1.0"	06093	03691
23032	CAT50 x TG100 - 4"	4"	2.362"	.094 - 1.0"	06093	03691
23034	CAT50 x TG100 - 6"	6"	2.362"	.094 - 1.0"	06093	03691
23035	CAT50 x TG100 - 8"	8"	2.362"	.094 - 1.0"	06093	03691



Features

- Coolant-thru spindle or thru flange (DIN B)
- Balanced to 25,000 RPM at G2.5
- T.I.R. 0.0001" or better from taper to collet pocket

PowerCOAT nut is included with each holder.
Techniks Certified for accuracy and balance
Each holder comes with a complete lab report

CoolFLEX holders are factory set for coolant-thru spindle. Simply remove 2 stop screws for DIN B coolant-thru flange.

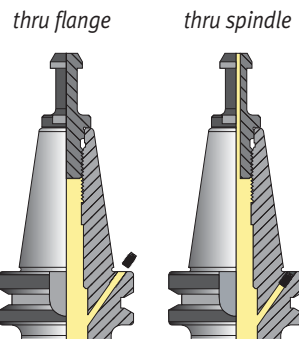
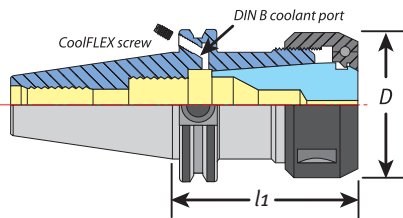

Part No.	CoolFLEX Screws
HSA-4-6	40 taper DIN B screw
HSA-6-6	50 taper DIN B screw

TG100 CoolFLEX Coolant -Thru Spindle or Flange (DIN B)

Part No.	Description	l1	D	Collet	Collet Range	Stop Screw	Wrench
23014F	CAT40 CoolFLEX x TG100 - 3"	3"	2.362"	TG100	.094 - 1.0"	06093	03691
23016F	CAT40 CoolFLEX x TG100 - 4"	4"	2.362"	TG100	.094 - 1.0"	06093	03691
23018F	CAT40 CoolFLEX x TG100 - 6"	6"	2.362"	TG100	.094 - 1.0"	06093	03691
23030F	CAT50 CoolFLEX x TG100 - 3"	3"	2.362"	TG100	.094 - 1.0"	06093	03691

Coolant Set Screws & Recommended Torque Values

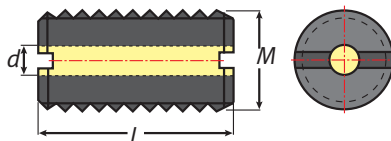

Coolant Set Screws

Part No.	Description	M	L	d
16080C-20	Coolant Set Screw	M5 x 0.8P	20mm	2.5
16082C-20	Coolant Set Screw	M8 x 1.25P	20mm	4
16083C-20	Coolant Set Screw	M10 x 1.5P	20mm	4
16085C-20	Coolant Set Screw	M12 x 1.75P	20mm	4
16089C-20	Coolant Set Screw	M16 x 02.0P	20mm	5
16091C-20	Coolant Set Screw	M20 x 2.0P	20mm	5



Collets
pg. 48



Nuts
pg. 62



Coolant
Rings
pg. 64



Retention
Knobs
pg. 200



Wrenches
pg. 204



Tightening
Stands
pg. 206

Recommended Collet & Retention Knob Tightening Torque

Collet	Nut Type	Collets I.D. OVER 1/16" (2mm)	Collets I.D. UNDER 1/16" (2mm)	Order Torque Wrench Adapter
ER16	slotted	42 ft/lbs	30 ft/lbs	04580-16
ER16	hex	42 ft/lbs	30 ft/lbs	04601-16
ER20	slotted	59 ft/lbs	24 ft/lbs	04580-20
ER20	hex	59 ft/lbs	24 ft/lbs	04602-20
ER25	slotted	77 ft/lbs	77 ft/lbs	04503-25
ER25	mini nut	25 ft/lbs	25 ft/lbs	04587
ER32	slotted	100 ft/lbs	100 ft/lbs	04604-32
ER40	slotted	130 ft/lbs	130 ft/lbs	04605-40
SYOZ 25	hook	90 ft/lbs	90 ft/lbs	03690-25
TG75	slotted	90 ft/lbs	90 ft/lbs	04604-32
TG100	hook	90 ft/lbs	90 ft/lbs	03690-25

Retention Knobs	Wrench Flats	Drive	Torque	Order Socket
BT30 Taper	0.535"	1/4"	36 ft/lbs	PSS-30BT
ISO 30 Taper	0.535"	3/8"	36 ft/lbs	PSS-30ISO
Any 40 Taper	0.750"	3/8"	76 ft/lbs	PSS-40
BT50 Taper	1.187"	1/2"	99 ft/lbs	PSC-50
CAT50 Taper	1.250"	1/2"	99 ft/lbs	PSC-50

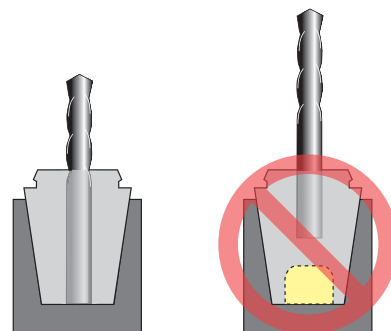

For maximum holding power fill the collet all the way with the tool shank (left) and use a PowerCOAT nut.

DIRECTIONS

1. Snap collet into nut.
2. Insert cutting tool into collet.
Make sure shank extends to the bottom of the collet.
3. Hand tighten collet nut assembly into toolholder.
4. Insert toolholder assembly into tightening fixture and secure it.
5. Tighten collet nut to recommended torque using a torque wrench and adapter.

Measurement Guide for Special Order Toolholders

V-flange CNC machine
make, model and spindle

v-flange tool #1 dimensions

D = _____
 F = _____
 W = _____
 A = _____
 N = _____

v-flange tool #2 dimensions

D = _____
 F = _____
 W = _____
 A = _____
 N = _____

HSK CNC machine
make, model and spindle

HSK tool #1 dimensions

D = _____
 F = _____
 W = _____
 A = _____
 N = _____

HSK tool #2 dimensions

D = _____
 F = _____
 W = _____
 A = _____
 N = _____

Fill in all the required dimensions (left).
Then, fax or phone in your order for a fast quote.

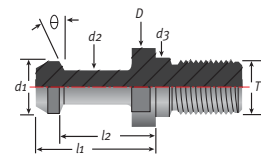
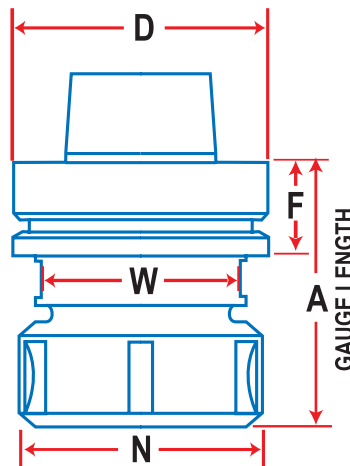
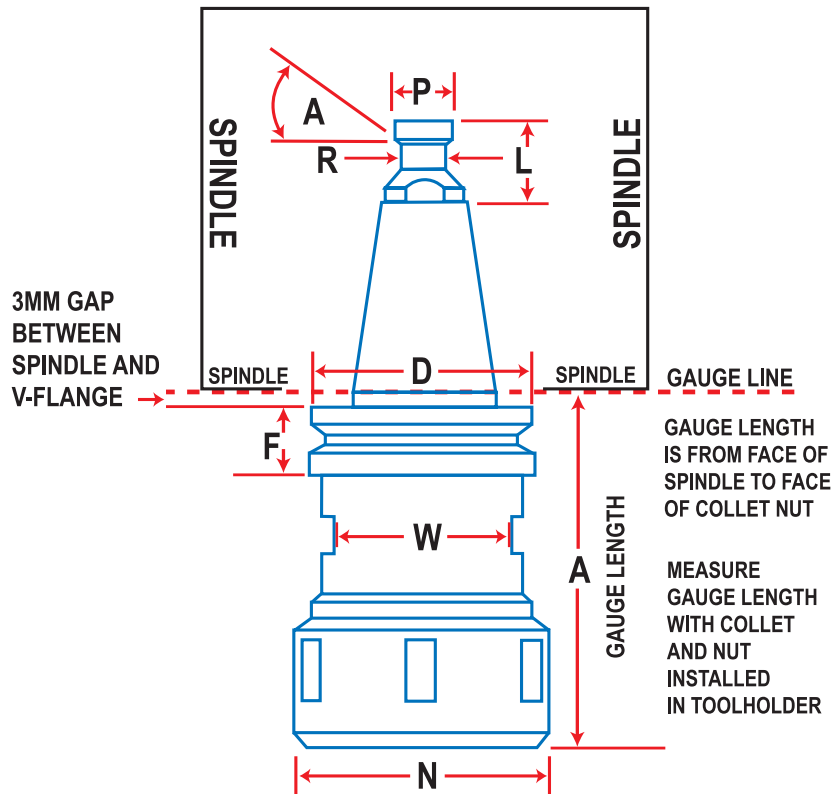

For special order retention knobs call (800) 597-3921

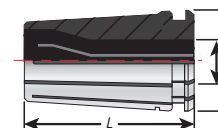

For special order collets call (800) 597-3921

Precision ER Collets, PowerCOAT Nuts, Other Collets

Full Line of ER Collets

Made from high-carbon bearing steel and heat treated for improved flexibility and longer life.



ER Inch Sizes



Sealed Coolant



Steel Sealed Coolant



ER Metric Sizes



Quick-Change Tap Collet



Floating Tap Collet



Rigid Tap Collet

PowerCOAT Nut

Points of Friction



threads



shoulder



Balanced up to to 70,000 RPMs

Our special PowerCOAT nut reduces friction so it can increase holding power by 75% compared to standard nuts. Holding power increases cutting tool life.

Other Collet Styles



DNA Dead Nuts
Accurate ER



TG75, TG100,
TG150



SYOZ / EOC
Perske



DA Double
Angle

You lose 10% of tool life for every .0001" of T.I.R.
The holding power and accuracy of Techniks collets
and PowerCOAT nuts extend cutting tool life.

Built for Speed.

Inch Size Precision ER Collets and Collet Sets

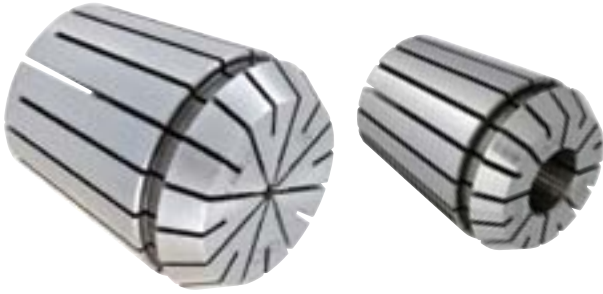

Inch Size ER Collet Features

- Average .0002" T.I.R.
- Clamping range: .039"
- Use with PowerCOAT nut (pg. 62) for best holding power and cutting tool life.

Compatible with DR, RD, ESX, AR, & BR series collets.

Ultra Precision Collets

- .0002" T.I.R. or better
- To order put "UP" in front of the part number



Nuts
pg. 62



Coolant
Rings
pg. 64



Retention
Knobs
pg. 200



Wrenches
pg. 204

ER8 Inch Size Collets

Part No.	Inch Range	Shank
04208-1/16	.043 – .062"	1/16"
04208-1/8	.086 – .125"	1/8"
04208-3/16	.148 – .187"	3/16"

ER Inch Size Collet Sets

Part No.	Size	Pieces	Collets Included	Fits Shank Sizes
04208IS	ER11	7	1/16 – 1/4" by 32nds	1/32 - 1/4"
04209IS	ER16	10	3/32 – 3/8" by 32nds	1/16 - 3/8"
04210IS	ER20	12	5/32 – 1/2" by 32nds	1/8 - 1/2"
04211IS	ER25	16	5/32 – 5/8" by 32nds	1/8 - 5/8"
04212IS	ER32	18	7/32 – 3/4" by 32nds	3/16 - 3/4"
04213IS	ER40	13	1/8 – 1.0" by 16ths	1/8 - 1.0"

ER11 Inch Size Collets

Part No.	Inch Range	Shank
04211-1/16	.043 – .062"	1/16"
04211-3/32	.054 – .093"	3/32"
04211-1/8	.086 – .125"	1/8"
04211-5/32	.117 – .156"	5/32"
04211-3/16	.148 – .187"	3/16"
04211-7/32	.179 – .218"	7/32"
04211-1/4	.211 – .250"	1/4"
04211-9/32	.242 – .281"	9/32"

ER16 Inch Size Collets

Part No.	Inch Range	Shank
04216-1/16	.043 – .062"	1/16"
04216-3/32	.054 – .093"	3/32"
04216-1/8	.086 – .125"	1/8"
04216-5/32	.117 – .156"	5/32"
04216-3/16	.148 – .187"	3/16"
04216-7/32	.179 – .218"	7/32"
04216-1/4	.211 – .250"	1/4"
04216-9/32	.242 – .281"	9/32"
04216-5/16	.273 – .312"	5/16"
04216-11/32	.304 – .343"	11/32"
04216-3/8	.336 – .375"	3/8"
04216-13/32	.367 – .406"	13/32"

ER20 Inch Size Collets

Part No.	Inch Range	Shank
04220-1/16	.043 – .062"	1/16"
04220-3/32	.054 – .093"	3/32"
04220-1/8	.086 – .125"	1/8"
04220-5/32	.117 – .156"	5/32"
04220-3/16	.148 – .187"	3/16"
04220-7/32	.179 – .218"	7/32"
04220-1/4	.211 – .250"	1/4"
04220-9/32	.242 – .281"	9/32"
04220-5/16	.273 – .312"	5/16"
04220-11/32	.304 – .343"	11/32"
04220-3/8	.336 – .375"	3/8"
04220-13/32	.367 – .406"	13/32"
04220-7/16	.398 – .437"	7/16"
04220-15/32	.429 – .468"	15/32"
04220-1/2	.461 – .500"	1/2"

Inch Size Precision ER Collets

ER25 Inch Size Collets

Part No.	Inch Range	Shank
04225-3/32	.054 – .093"	3/32"
04225-1/8	.086 – .125"	1/8"
04225-5/32	.117 – .156"	5/32"
04225-3/16	.148 – .187"	3/16"
04225-7/32	.179 – .218"	7/32"
04225-1/4	.211 – .250"	1/4"
04225-9/32	.242 – .281"	9/32"
04225-5/16	.273 – .312"	5/16"
04225-11/32	.304 – .343"	11/32"
04225-3/8	.336 – .375"	3/8"
04225-13/32	.367 – .406"	13/32"
04225-7/16	.398 – .437"	7/16"
04225-15/32	.429 – .468"	15/32"
04225-1/2	.461 – .500"	1/2"
04225-17/32	.492 – .531"	17/32"
04225-9/16	.523 – .562"	9/16"
04225-19/32	.554 – .593"	19/32"
04225-5/8	.586 – .625"	5/8"
04225-3/4	.711 – .750"	3/4"

ER32 Inch Size Collets

Part No.	Inch Range	Shank
04232-1/16	.043 – .062"	1/16"
04232-3/32	.054 – .093"	3/32"
04232-1/8	.086 – .125"	1/8"
04232-5/32	.117 – .156"	5/32"
04232-3/16	.148 – .187"	3/16"
04232-7/32	.179 – .218"	7/32"
04232-1/4	.211 – .250"	1/4"
04232-9/32	.242 – .281"	9/32"
04232-5/16	.273 – .312"	5/16"
04232-11/32	.304 – .343"	11/32"
04232-3/8	.336 – .375"	3/8"
04232-13/32	.367 – .406"	13/32"
04232-7/16	.398 – .437"	7/16"
04232-15/32	.429 – .468"	15/32"
04232-1/2	.461 – .500"	1/2"
04232-17/32	.492 – .531"	17/32"
04232-9/16	.523 – .562"	9/16"
04232-19/32	.554 – .593"	19/32"
04232-5/8	.586 – .625"	5/8"
04232-21/32	.617 – .656"	21/32"
04232-11/16	.648 – .687"	11/16"
04232-23/32	.679 – .718"	23/32"
04232-3/4	.711 – .750"	3/4"

ER40 Inch Size Collets

Part No.	Inch Range	Shank
04240-1/8	.086 – .125"	1/8"
04240-5/32	.117 – .156"	5/32"
04240-3/16	.148 – .187"	3/16"
04240-7/32	.179 – .218"	7/32"
04240-1/4	.211 – .250"	1/4"
04240-9/32	.242 – .281"	9/32"
04240-5/16	.273 – .312"	5/16"
04240-11/32	.304 – .343"	11/32"
04240-3/8	.336 – .375"	3/8"
04240-13/32	.367 – .406"	13/32"
04240-7/16	.398 – .437"	7/16"
04240-15/32	.429 – .468"	15/32"
04240-1/2	.461 – .500"	1/2"
04240-17/32	.492 – .531"	17/32"
04240-9/16	.523 – .562"	9/16"
04240-19/32	.554 – .593"	19/32"
04240-5/8	.586 – .625"	5/8"
04240-21/32	.617 – .656"	21/32"
04240-11/16	.648 – .687"	11/16"
04240-23/32	.679 – .718"	23/32"
04240-3/4	.711 – .750"	3/4"
04240-25/32	.742 – .781"	25/32"
04240-13/16	.773 – .812"	13/16"
04240-27/32	.807 – .843"	27/32"
04240-7/8	.836 – .875"	7/8"
04240-29/32	.867 – .906"	29/32"
04240-15/16	.898 – .937"	15/16"
04240-31/32	.929 – .968"	31/32"
04240-1	.961 – 1.00"	1.0"

Use the table (below) for selecting your replacement collets. ER collets all have unique length and diameter measurements.

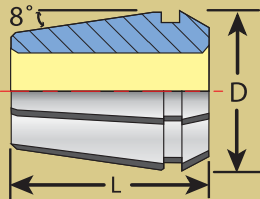

ER Size	L	D
ER8	13mm (.51")	8.5mm (.33")
ER11	18mm (.708")	11.5mm (.45")
ER16	27.5mm (1.08")	17mm (.67")
ER20	31.5mm (1.24")	21mm (.83")
ER25	34mm (1.34")	26mm (1.02")
ER32	40mm (1.57")	33mm (1.3")
ER40	46mm (1.81")	41mm (1.61")
ER50	60 mm (2.36")	52mm (2.05")

ER50 Inch Size Collets

Part No.	Inch Range	Shank
04250-1/2	.461 – .500"	1/2"
04250-5/8	.586 – .625"	5/8"
04250-3/4	.711 – .750"	3/4"
04250-7/8	.836 – .875"	7/8"
04250-1	.961 – 1.00"	1.0"
04250-1-1/4	1.211 – 1.250"	1-1/4"

Metric Size Precision ER Collets and Collet Sets

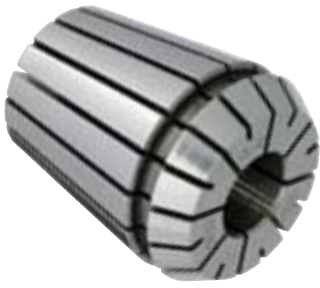

Compatible with DR, RD, ESX, AR, & BR series collets.

To Order Ultra Precision Collets

Hand-selected Ultra Precision collets are guaranteed .0002" T.I.R. or better. Just place "UP" in front of the regular part number when ordering.



Metric ER Precision Collet Features

- Average .0002" T.I.R.
- Clamping range: .039"
- Use with PowerCOAT nut (pg. 62) for best holding power and cutting tool life.

ER Metric Collet Sets

Part No.	Size	Pieces	Collets Included	Fits Shank Sizes
04200MS	ER8	9	1 - 5mm by 0.5mm	.5 – 5mm
04201MS	ER11	13	1 - 7mm by 0.5mm	.5 – 7mm
04202MS	ER16	10	1 - 10mm by 1mm	.5 – 10mm
04203MS	ER20	12	2 - 13mm by 1mm	1.0 – 13mm
04204MS	ER25	15	2 - 16mm by 1mm	1.0 – 16mm
04205MS	ER32	18	3 - 20mm by 1mm	2 – 20mm
04206MS	ER40	23	4 - 26mm by 1mm	3 – 26mm
04207MS	ER50	17	6 - 34mm by 2 mm	5 – 34mm

ER8 Precision Metric Collets

Part No.	Inch Range	Shank
04208-01.0	.019 – .039"	0.5 – 1.0
04208-01.5	.039 – .059"	1.0 – 1.5
04208-02.0	.059 – .079"	1.5 – 2.0
04208-02.5	.079 – .098"	2.0 – 2.5
04208-03.0	.098 – .118"	2.5 – 3.0
04208-03.5	.118 – .138"	3.0 – 3.5
04208-04.0	.138 – .157"	3.5 – 4.0
04208-04.5	.157 – .177"	4.0 – 4.5
04208-05.0	.177 – .197"	4.5 – 5.0

ER11 Precision Metric Collets

Part No.	Inch Range	Shank
04211-01.0	.019 – .039"	0.5 – 1.0
04211-01.5	.039 – .059"	1.0 – 1.5
04211-02.0	.059 – .079"	1.5 – 2.0
04211-02.5	.079 – .098"	2.0 – 2.5
04211-03.0	.098 – .118"	2.5 – 3.0
04211-03.5	.118 – .138"	3.0 – 3.5
04211-04.0	.138 – .157"	3.5 – 4.0
04211-04.5	.157 – .177"	4.0 – 4.5
04211-05.0	.177 – .197"	4.5 – 5.0
04211-05.5	.197 – .217"	5.0 – 5.5
04211-06.0	.217 – .236"	5.5 – 6.0
04211-06.5	.236 – .256"	6.0 – 6.5
04211-07.0	.256 – .276"	6.5 – 7.0

ER16 Precision Metric Collets

Part No.	Inch Range	Shank
04216-01	.019 – .039"	0.5–1
04216-01.5	.039 – .059"	1.0–1.5
04216-02	.039 – .079"	1.5–2
04216-02.5	.059 – .098"	1.5–2.5
04216-03	.079 – .118"	2–3
04216-03.5	.098 – .137"	2.5–3.5
04216-04	.118 – .157"	3–4
04216-04.5	.137 – .177"	3.5–4.5
04216-05	.157 – .197"	4–5
04216-05.5	.177 – .216"	4.5–5.5
04216-06	.197 – .236"	5–6
04216-06.5	.216 – .255"	5.5–6.5
04216-07	.236 – .276"	6–7
04216-07.5	.255 – .295"	6.5–7.5
04216-08	.276 – .315"	7–8
04216-08.5	.295 – .334"	7.5–8.5
04216-09	.315 – .354"	8–9
04216-09.5	.334 – .374"	8.5–9.5
04216-10	.354 – .394"	9–10
04216-10.5	.374 – .413"	9.5–10.5

ER20 Precision Metric Collets

Part No.	Inch Range	Shank
04220-01	.019 – .039"	0.5–1
04220-01.5	.039 – .059"	1.0–1.5
04220-02	.039 – .079"	1.5–2
04220-02.5	.059 – .098"	1.5–2.5
04220-03	.079 – .118"	2–3
04220-03.5	.098 – .137"	2.5–3.5
04220-04	.118 – .157"	3–4
04220-04.5	.137 – .177"	3.5–4.5
04220-05	.157 – .197"	4–5
04220-05.5	.177 – .216"	4.5–5.5
04220-06	.197 – .236"	5–6
04220-06.5	.216 – .255"	5.5–6.5
04220-07	.236 – .276"	6–7
04220-07.5	.255 – .295"	6.5–7.5
04220-08	.276 – .315"	7–8
04220-08.5	.295 – .334"	7.5–8.5
04220-09	.315 – .354"	8–9
04220-09.5	.334 – .374"	8.5–9.5
04220-10	.354 – .394"	9–10
04220-10.5	.374 – .413"	9.5–10.5
04220-11	.394 – .433"	10–11
04220-11.5	.413 – .452"	10.5–11.5
04220-12	.433 – .472"	11–12
04220-12.5	.452" – .492"	11.5–12.5
04220-13	.472 – .512"	12–13
04220-13.5	.492 – .531"	12.5–13.5
04220-14	.512 – .551"	13–14

Metric Size Precision ER Collets

ER25 Precision Metric Collets

Part No.	Inch Range	Shank mm
04225-02	.039 – .079"	1.5–2
04225-02.5	.059 – .098"	2–2.5
04225-03	.079 – .118"	2–3
04225-03.5	.098 – .137"	2.5–3.5
04225-04	.118 – .157"	3–4
04225-05	.157 – .197"	4–5
04225-06	.197 – .236"	5–6
04225-07	.236 – .276"	6–7
04225-08	.276 – .315"	7–8
04225-09	.315 – .354"	8–9
04225-10	.354 – .394"	9–10
04225-11	.394 – .433"	10–11
04225-12	.433 – .472"	11–12
04225-13	.472 – .512"	12–13
04225-14	.512 – .551"	13–14
04225-15	.551 – .591"	14–15
04225-16	.591 – .630"	15–16
04225-17	.630 – .669"	16–17

Use the table (below) for selecting your replacement collets. ER collets all have unique length and diameter measurements.

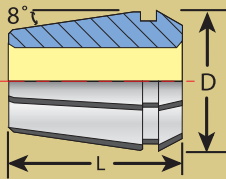

Size	L	D
ER8	13mm (.51")	8.5mm (.33")
ER11	18mm (.708")	11.5mm (.45")
ER16	27.5mm (1.08")	17mm (0.67")
ER20	31.5mm (1.24")	21mm (0.83")
ER25	34mm (1.34")	26mm (1.02")
ER32	40mm (1.57")	33mm (1.3")
ER40	46mm (1.81")	41mm (1.61")
ER50	60mm (2.36")	52mm (2.05")

ER32 Precision Metric Collets

Part No.	Inch Range	Shank mm
04232-03	.079 – .118"	2–3
04232-03.5	.098 – .137"	2.5–3.5
04232-04	.118 – .157"	3–4
04232-04.5	.137 – .177"	3.5–4.5
04232-05	.157 – .197"	4–5
04232-05.5	.177 – .216"	4.5–5.5
04232-06	.197 – .236"	5–6
04232-06.5	.216 – .255"	5.5–6.5
04232-07	.236 – .276"	6–7
04232-07.5	.255 – .295"	6.5–7.5
04232-08	.276 – .315"	7–8
04232-08.5	.295 – .334"	7.5–8.5
04232-09	.315 – .354"	8–9
04232-09.5	.334 – .374"	8.5–9.5
04232-10	.354 – .394"	9–10
04232-10.5	.374 – .413"	9.5–10.5
04232-11	.394 – .433"	10–11
04232-11.5	.413 – .452"	10.5–11.5
04232-12	.433 – .472"	11–12
04232-12.5	.452 – .492"	11.5–12.5
04232-13	.472 – .512"	12–13
04232-13.5	.492 – .531"	12.5–13.5
04232-14	.512 – .551"	13–14
04232-14.5	.531 – .570"	13.5–14.5
04232-15	.551 – .591"	14–15
04232-15.5	.570 – .610"	14.5–15.5
04232-16	.591 – .630"	15–16
04232-16.5	.610" – .649"	15.5–16.5
04232-17	.630 – .669"	16–17
04232-17.5	.649 – .688"	16.5–17.5
04232-18	.669 – .709"	17–18
04232-18.5	.688 – .728"	17.5–18.5
04232-19	.709 – .748"	18–19
04232-19.5	.728 – .767"	18.5–19.5
04232-20	.748 – .787"	19–20
04232-21	.787 – .827"	20–21

ER40 Precision Metric Collets

Part No.	Inch Range	Shank mm
04240-04	.118 – .157"	3–4
04240-05	.157 – .197"	4–5
04240-06	.197 – .236"	5–6
04240-07	.236 – .276"	6–7
04240-08	.276 – .315"	7–8
04240-09	.315 – .354"	8–9
04240-10	.354 – .394"	9–10
04240-11	.394 – .433"	10–11
04240-12	.433 – .472"	11–12
04240-13	.472 – .512"	12–13
04240-14	.512 – .551"	13–14
04240-15	.551 – .591"	14–15
04240-16	.591 – .630"	15–16
04240-17	.630 – .669"	16–17
04240-18	.669 – .709"	17–18
04240-19	.709 – .748"	18–19
04240-20	.748 – .787"	19–20
04240-21	.787 – .827"	20–21
04240-22	.827 – .866"	21–22
04240-23	.866 – .906"	22–23
04240-24	.906 – .945"	23–24
04240-25	.945 – .984"	24–25
04240-26	.984 – 1.024"	25–26

ER50 Precision Metric Collets

Part No.	Inch Range	Shank mm
04250-06	.197 – .236"	5–6
04250-07	.236 – .276"	6–7
04250-08	.276 – .315"	7–8
04250-09	.315 – .354"	8–9
04250-10	.354 – .394"	9–10
04250-12	.394 – .472"	10–12
04250-14	.472 – .551"	12–14
04250-16	.551 – .630"	14–16
04250-18	.630 – .709"	16–18
04250-20	.709 – .787"	18–20
04250-22	.787 – .866"	20–22
04250-24	.866 – .945"	22–24
04250-26	.945 – 1.024"	24–26
04250-28	1.024 – 1.102"	26–28
04250-30	1.102 – 1.181"	28–30
04250-32	1.181 – 1.259"	30–32
04250-34	1.259 – 1.338"	32–34

DNA – Dead Nuts Accurate Collets For Small Size Tools

DNA Collets Features

- .0002" T.I.R. extends cutting tool life!
- Best collet for tools 1/8" (6mm) and smaller
- More rigid and more accurate than ER, but works with your ER holders

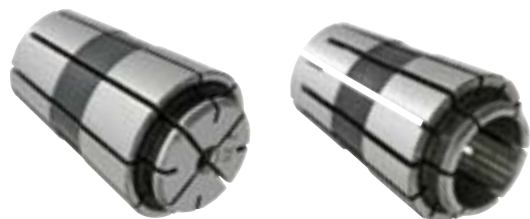

DNA 11 Dead Nuts Accurate Collets

Part No.	Shank Size inch/mm	Range inch /mm
05952-02	5/64" / 1.5 - 2mm	.059" - .079" / .5mm
05952-03	7/64" / 2.5 - 3mm	.098" - .118" / .5mm
05952-03.5	1/8" / 3 - 3.5mm	.118" - .138" / .5mm
05952-04	5/32" / 3.5 - 4mm	.138" - .157" / .5mm
05952-05	3/16" / 4.5 - 5mm	.177" - .197" / .5mm
05952-06	15/64" / 5.5 - 6mm	.216" - .236" / .5mm
05952-1/8	exact size collet: 1/8"	.105" - .125" / .5mm
05952-3/16	exact size collet: 3/16"	.167" - .187" / .5mm
05952-1/4	exact size collet: 1/4"	.230" - .250" / .5mm
2011.0000	DNA 11 nut M14 x .75"	
04608	DNA 11 collet wrench	
DNA11TWA	DNA 11 torque wrench adapter	

ER Collet **DNA Collet**

DNA collets hold small tools with greater rigidity and more accuracy (T.I.R.) for greatly improved tool life.

DNA 16 Dead Nuts Accurate Collets

Part No.	Shank Size inch/mm	Range inch/mm
05954-0.3	.2 - .3mm	.007" - .011" / .10mm
05954-0.4	1/64" / .3 - .4mm	.011" - .015" / .10mm
05954-0.5	.4 - .5mm	.015" - .019" / .10mm
05954-0.6	.5 - .6mm	.019" - .023" / .10mm
05954-0.8	1/32" / .7 - .8mm	.027" - .031" / .10mm
05954-1.0	.9 - 1.0mm	.035" - .039" / .10mm
05954-1.2	3/64" / 1.1 - 1.2mm	.043" - .047" / .10mm
05954-1.25	1.0 - 1.25mm	.039" - .049" / .25mm
05954-1.5	1.25 - 1.5mm	.049" - .059" / .25mm
05954-1.75	1/16" / 1.5 - 1.75mm	.059" - .068" / .25mm
05954-02	5/64" / 1.75 - 2mm	.068" - .078" / .25mm
05954-2.25	2 - 2.25mm	.078" - .088" / .25mm
05954-2.5	3/32" / 2.25 - 2.5mm	.088" - .098" / .25mm
05954-03	2.5 - 3mm	.098" - .118" / .5mm
05954-3.5	1/8" / 3 - 3.5mm	.118" - .138" / .5mm
05954-04	5/32" / 3.5 - 4mm	.137" - .157" / .5mm
05954-4.5	4 - 4.5mm	.157" - .177" / .5mm
05954-05	3/16" / 4 - 5mm	.157" - .197" / .25mm
05954-06	7/32" / 5 - 6mm	.196" - .236" / 1.0mm
05954-07	1/4" / 6 - 7mm	.236" - .275" / 1.0mm
05954-08	5/16" / 7 - 8mm	.275" - .314" / 1.0mm
05954-09	11/32" / 8 - 9mm	.314" - .354" / 1.0mm
05954-10	3/8" / 9 - 10mm	.354" - .392" / 1.0mm
05954-1/8	exact size collet: 1/8"	.105" - .125" / .5mm
05954-3/16	exact size collet: 3/16"	.147" - .187" / 1.0mm
05954-1/4	exact size collet: 1/4"	.210" - .25" / 1.0mm
05954-3/8	exact size collet: 3/8"	.335 - .375" / 1.0mm

For Best Results Use DNA Collets & Nuts



DNA 16 Nut

Coolant Nut for 1/8" and 3mm

DNA Sealed Nut



Coolant Rings
pg. 64



Retention Knobs
pg. 200



Wrenches
pg. 204

DNA nuts feature PowerCOAT for 75% more holding power and best tool life.

DNA 16 Nuts, Sealed Nuts, Wrenches and TWAs

Part No.	Description
2016-2000	DNA16 Mini Nut - M19 x 1.0" x O.D. 25mm
27116	M22 x 1.5 nut, , O.D. 27mm
27216	M22 x 1.5 nut* 1/8" o-ring
27116-30	3.0 - 2.5mm sealed nut, O.D. 27mm
27116-40	4.0 - 3.5mm sealed nut, O.D. 27mm
27116-45	4.5 - 4.0mm sealed nut, O.D. 27mm
27116-50	5.0 - 4.5mm sealed nut, O.D. 27mm
27116-55	5.5 - 5mm sealed nut, O.D. 27mm
27116-60	6.0 - 5.5mm sealed nut, O.D. 27mm
27116-65	6.5 - 6mm sealed nut, O.D. 27mm
DNA16W	DNA 16 collet wrench
DNA16TWA	DNA 16 torque wrench adapter
894-22	DNA 16 mini nut wrench

DNA 20 Dead Nuts Accurate Collets

Part No.	Shank Size inch/mm	Range inch/mm
05956-03	2.5 - 3mm	.098" - .118" / .5mm
05956-3.5	1/8" / 3 - 3.5mm	.118" - .138" / .5mm
05956-04	5/32" / 3.5 - 4mm	.137" - .157" / .5mm
05956-05	3/16" / 4 - 5mm	.157" - .197" / 1.0mm
05956-06	7/32" 5 - 6mm	.197" - .236" / 1.0mm
05956-1/8	exact size collet: 1/8"	.105" - .125" / .5mm
05956-3/16	exact size collet: 3/16"	.147" - .187" / 1.0mm
05956-1/4	exact size collet: 1/4"	.210" - .250" / 1.0mm
05956-3/8	exact size collet: 3/8"	.335" - .375" / 1.0mm
2020.0000	DNA 20 nut, M25 x 1.5" x O.D. 32mm	
2020.0000C	DNA 20 coolant nut, uses ER20 rings on page 64	
DNA20W	DNA 20 collet wrench	
DNA20TWA	DNA 20 torque wrench adapter	

DNA 32 Dead Nuts Accurate Collets

Part No.	Shank Size inch/mm	Range inch/mm
05958-03	2.5 - 3mm	.098" - .118" / .5mm
05958-3.5	1/8" / 3 - 3.5mm	.118" - .138" / .5mm
05958-04	5/32" / 3.5 - 4mm	.137" - .157" / .5mm
05958-05	3/16" / 4 - 5mm	.157" - .197" / 1.0mm
05958-06	7/32" 5 - 6mm	.197" - .236" / 1.0mm
05958-1/8	exact size collet: 1/8"	.105" - .125" / .5mm
05958-3/16	exact size collet: 3/16"	.147" - .187" / 1.0mm
05958-1/4	exact size collet: 1/4"	.210" - .250" / 1.0mm
05958-3/8	exact size collet: 3/8"	.335" - .375" / 1.0mm
05958-1/2	exact size collet: 1/2"	.5"
05958-3/4	exact size collet: 3/4"	.75"
05958-13	exact size collet: 13mm	13mm
05958-20	exact size collet: 20mm	20 mm
1132.0000	DNA 32 nut, M40 x 1.5" x O.D. 47.5mm	
1132.0000C	DNA 32 coolant nut, uses ER25 rings on page 64	
DNA32W	DNA 32 collet wrench	
DNA32TWA	DNA 32 torque wrench adapter	

Steel Sealed Precision ER Coolant Collets – Inch Size



Features

- Sealed to 2000 PSI
- No plugs
- Protects toolholder from contaminants
- Use with ER PowerCOAT nuts (page 62)

Designed for use with on-size tools.

Use with ER, RD, DR, ESX or BR collet chucks.



Nuts
pg. 62



Coolant
Rings
pg. 64



Retention
Knobs
pg. 200



Wrenches
pg. 204

ER Inch Size Collet Sets

Part No.	Size	Pcs.	Fits Shank Sizes
04543IS	ER16	10	3/32 - 3/8"
04544IS	ER20	12	5/32 - 1/2"
04545IS	ER25	14	7/32 - 5/8"
04546IS	ER32	18	7/32 - 3/4"
04547IS	ER40	15	3/8 - 1.0"

ER16 Inch Size

Part No.	Shank
04543-3/32	3/32"
04543-1/8	1/8"
04543-5/32	5/32"
04543-3/16	3/16"
04543-7/32	7/32"
04543-1/4	1/4"
04543-9/32	9/32"
04543-5/16	5/16"
04543-11/32	11/32"
04543-3/8	3/8"
04543-13/32	13/32"

ER20 Inch Size

Part No.	Shank
04544-1/8	1/8"
04544-5/32	5/32"
04544-3/16	3/16"
04544-7/32	7/32"
04544-1/4	1/4"
04544-9/32	9/32"
04544-5/16	5/16"
04544-11/32	11/32"
04544-3/8	3/8"
04544-13/32	13/32"
04544-7/16	7/16"
04544-15/32	15/32"
04544-1/2	1/2"

ER25 Inch Size

Part No.	Shank
04545-7/32	7/32"
04545-1/4	1/4"
04545-9/32	9/32"
04545-5/16	5/16"
04545-11/32	11/32"
04545-3/8	3/8"
04545-13/32	13/32"
04545-7/16	7/16"
04545-15/32	15/32"
04545-1/2	1/2"
04545-17/32	17/32"
04545-9/16	9/16"
04545-19/32	19/32"
04545-5/8	5/8"

ER32 Inch Size

Part No.	Shank
04546-7/32	7/32"
04546-1/4	1/4"
04546-9/32	9/32"
04546-5/16	5/16"
04546-11/32	11/32"
04546-3/8	3/8"
04546-13/32	13/32"
04546-7/16	7/16"
04546-15/32	15/32"
04546-1/2	1/2"
04546-17/32	17/32"
04546-9/16	9/16"
04546-19/32	19/32"
04546-5/8	5/8"
04546-21/32	21/32"
04546-11/16	11/16"
04546-23/32	23/32"
04546-3/4	3/4"

ER40 Inch Size

Part No.	Shank
04547-3/8	3/8"
04547-13/32	13/32"
04547-7/16	7/16"
04547-15/32	15/32"
04547-1/2	1/2"
04547-17/32	17/32"
04547-9/16	9/16"
04547-19/32	19/32"
04547-5/8	5/8"
04547-21/32	21/32"
04547-11/16	11/16"
04547-23/32	23/32"
04547-3/4	3/4"
04547-7/8	7/8"
04547-1	1.0"

Steel Sealed Precision ER Coolant Collets – Metric Size



Features

- Sealed to 2000 PSI
- No plugs
- Protects toolholder from contaminants
- Use with ER PowerCOAT nuts (page 62)

Designed for use with on-size tools.

Use with ER, RD, DR, ESX or BR collet chucks.



ER Metric Size Collet Sets

Part No.	Size	Pcs.	Fits Shank Sizes
04543MS	ER16	8	3 - 10mm
04544MS	ER20	11	3 - 13mm
04545MS	ER25	14	3 - 16mm
04546MS	ER32	18	3 - 20mm

ER16 Metric Size

Part No.	Shank
04543-03	3mm
04543-04	4mm
04543-05	5mm
04543-06	6mm
04543-07	7mm
04543-08	8mm
04543-09	9mm
04543-10	10mm

ER20 Metric Size

Part No.	Shank
04544-03	3mm
04544-04	4mm
04544-05	5mm
04544-06	6mm
04544-07	7mm
04544-08	8mm
04544-09	9mm
04544-10	10mm
04544-11	11mm
04544-12	12mm
04544-13	13mm

ER25 Metric Size

Part No.	Shank
04545-03	3mm
04545-04	4mm
04545-05	5mm
04545-06	6mm
04545-07	7mm
04545-08	8mm
04545-09	9mm
04545-10	10mm
04545-11	11mm
04545-12	12mm
04545-13	13mm
04545-14	14mm
04545-15	15mm
04545-16	16mm

ER32 Metric Size

Part No.	Shank
04546-03	3mm
04546-04	4mm
04546-05	5mm
04546-06	6mm
04546-07	7mm
04546-08	8mm
04546-09	9mm
04546-10	10mm
04546-11	11mm
04546-12	12mm
04546-13	13mm
04546-14	14mm
04546-15	15mm
04546-16	16mm
04546-17	17mm
04546-18	18mm
04546-19	19mm
04546-20	20mm

ER40 Metric Size

Part No.	Shank
04547-06	6mm
04547-07	7mm
04547-08	8mm
04547-09	9mm
04547-10	10mm
04547-11	11mm
04547-12	12mm
04547-13	13mm
04547-14	14mm
04547-15	15mm
04547-16	16mm
04547-17	17mm
04547-18	18mm
04547-19	19mm
04547-20	20mm
04547-25	25mm

Precision ER Sealed Metric Coolant Collets



Features

- Larger plugs for 750 PSI coolant
- Use with ER PowerCOAT nuts (page 62)
- Exclusive design reduces points of failure 50%

Use with ER, RD, DR, ESX or BR collet chucks.

Other inch sizes available from stock in ER16 & ER20.

ER16 Sealed Collets

Part No.	Shank
08316-03.0	3mm
08316-03.5	3.5mm
08316-04.0	4mm
08316-04.5	4.5mm
08316-05.0	5mm
08316-05.5	5.5mm
08316-06.0	6mm
08316-1/4	1/4"
08316-06.5	6.5mm
08316-07.0	7mm
08316-07.5	7.5mm
08316-08.0	8mm
08316-08.5	8.5mm
08316-09.0	9mm
08316-09.5	9.5mm
08316-10.0	10mm

ER20 Sealed Collets

Part No.	Shank
08320-03.0	3mm
08320-03.5	3.5mm
08320-04.0	4mm
08320-04.5	4.5mm
08320-05.0	5mm
08320-05.5	5.5mm
08320-06.0	6mm
08320-1/4	1/4"
08320-06.5	6.5mm
08320-07.0	7mm
08320-07.5	7.5mm
08320-08.0	8mm
08320-08.5	8.5mm
08320-09.0	9mm
08320-09.5	9.5mm
08320-10.0	10mm
08320-10.5	10.5mm
08320-11.0	11mm
08320-11.5	11.5mm
08320-12.0	12mm
08320-12.5	12.5mm
08320-1/2	1/2"
08320-13.0	13mm

Sealed Collet Sets

Part No.	Description
08316MS	15 pcs. ER16
08320MS	21 pcs ER20
08325MS	27 pcs ER25
08332-35MS	35 pcs ER32
08340-41MS	41 pcs ER40

ER25 Sealed Collets

Part No.	Shank
08325-03.0	3mm
08325-03.5	3.5mm
08325-04.0	4mm
08325-04.5	4.5mm
08325-05.0	5mm
08325-05.5	5.5mm
08325-06.0	6mm
08325-1/4	1/4"
08325-06.5	6.5mm
08325-07.0	7mm
08325-07.5	7.5mm
08325-08.0	8mm
08325-08.5	8.5mm
08325-09.0	9mm
08325-09.5	9.5mm
08325-10.0	10mm
08325-10.5	10.5mm
08325-11.0	11mm
08325-11.5	11.5mm
08325-12.0	12mm
08325-12.5	12.5mm
08325-1/2	1/2"
08325-13.0	13mm
08325-13.5	13.5mm
08325-14.0	14mm
08325-14.5	14.5mm
08325-15.0	15mm
08325-15.5	15.5mm
08325-16.0	16mm

ER32 Sealed Collets

Part No.	Shank
08332-03.0	3mm
08332-03.5	3.5mm
08332-04.0	4mm
08332-04.5	4.5mm
08332-05.0	5mm
08332-05.5	5.5mm
08332-06.0	6mm
08332-1/4	1/4"
08332-06.5	6.5mm
08332-07.0	7mm
08332-07.5	7.5mm
08332-08.0	8mm
08332-08.5	8.5mm
08332-09.0	9mm
08332-09.5	9.5mm
08332-10.0	10mm
08332-10.5	10.5mm
08332-11.0	11mm
08332-11.5	11.5mm
08332-12.0	12mm
08332-12.5	12.5mm
08332-1/2	1/2"
08332-13.0	13mm
08332-13.5	13.5mm
08332-14.0	14mm
08332-14.5	14.5mm
08332-15.0	15mm
08332-15.5	15.5mm
08332-16.0	16mm
08332-16.5	16.5mm
08332-17.0	17mm
08332-17.5	17.5mm
08332-18.0	18mm
08332-18.5	18.5mm
08332-19	19mm
08332-3/4	3/4"
08332-19.5	19.5mm
08332-20.0	20mm

ER40 Sealed Collets

Part No.	Shank
08340-06.0	6mm
08340-1/4	1/4"
08340-06.5	6.5mm
08340-07.0	7mm
08340-07.5	7.5mm
08340-08.0	8mm
08340-08.5	8.5mm
08340-09.0	9mm
08340-09.5	9.5mm
08340-10.0	10mm
08340-10.5	10.5mm
08340-11.0	11mm
08340-11.5	11.5mm
08340-12.0	12mm
08340-12.5	12.5mm
08340-1/2	1/2"
08340-13.0	13mm
08340-13.5	13.5mm
08340-14.0	14mm
08340-14.5	14.5mm
08340-15.0	15mm
08340-15.5	15.5mm
08340-16.0	16mm
08340-16.5	16.5mm
08340-17.0	17mm
08340-17.5	17.5mm
08340-18.0	18mm
08340-18.5	18.5mm
08340-19.0	19mm
08340-3/4	3/4"
08340-19.5	19.5mm
08340-20.0	20mm
08340-20.5	20.5mm
08340-21.0	21mm
08340-21.5	21.5mm
08340-22.0	22mm
08340-22.5	22.5mm
08340-23.0	23mm
08340-23.5	23.5mm
08340-24.0	24mm
08340-24.5	24.5mm
08340-25.0	25mm
08340-25.5	25.5mm
08340-26.0	26mm
08340-1	25.4mm

Precision ER Floating Tap Collets and Collet Sets



Features

- Axial compensation prevents breaking taps
- Replaces expensive tapping heads
- Locking feature prevents spinning the tap
- Reduce tapping clearance requirements

Compatible with these standard collet chucks:
ER, DR, RD, ESX, BR or DIN 6499 collet pockets.



Nuts
pg. 62



Coolant
Rings
pg. 64



Retention
Knobs
pg. 200



Wrenches
pg. 204

Applications: CNC lathes, VDI turrets, angle heads, CNC machine center, swiss style turning machines, and driven heads on CNC lathe turrets.

Simply program the machine 5% behind the recommended pitch feed of the tap to make the floating collet work. Return out of the tapped hole at 100%.

For best performance use FT tap collets with Techniks PowerCOAT nut.
See page 62.

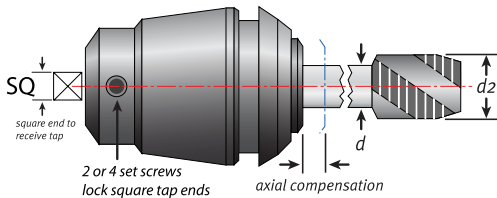

FT Collet Sets

Part No.	Description
05916IS	4 piece collet set
05920IS	5 piece collet set
05925IS	9 piece collet set
05932IS	11 piece collet set

FT-116 Floating Tap Collets

Part No.	d	SQ	Size (d2)
05916-141	.141"	.110"	1/8" or #6
05916-168	.168"	.131"	5/32" or #8
05916-194	.194"	.152"	3/16" or #10
05916-220	.220"	.165"	7/32" or #12

axial compensation = 7mm

FT-120 Floating Tap Collets

Part No.	d	SQ	Size (d2)
05920-141	.141"	.110"	1/8" or #6
05920-168	.168"	.131"	5/32" or #8
05920-194	.194"	.152"	3/16" or #10
05920-220	.220"	.165"	7/32" or #12
05920-255	.255"	.191"	1/4"

axial compensation = 7mm

FT-125 Floating Tap Collets

Part No.	d	SQ	Size (d2)
05925-141	.141"	.110"	1/8" or #6
05925-168	.168"	.131"	5/32" or #8
05925-194	.194"	.152"	3/16" or #10
05925-220	.220"	.165"	7/32" or #12
05925-255	.255"	.191"	1/4"
05925-318	.318"	.238"	5/16"
05925-323	.323"	.242"	7/16"
05925-367	.367"	.275"	1/2"
05925-381	.381"	.286"	3/8"

axial compensation = 8mm

FT-132 Floating Tap Collets

Part No.	d	SQ	Size (d2)
05932-168	.168"	.131"	5/32" or #8
05932-194	.194"	.152"	3/16" or #10
05932-220	.220"	.165"	7/32" or #12
05932-255	.255"	.191"	1/4"
05932-318	.318"	.238"	5/16"
05932-323	.323"	.242"	7/16"
05932-367	.367"	.275"	1/2"
05932-381	.381"	.286"	3/8"
05932-429	.429"	.322"	9/16"
05932-437	.437"	.328"	1/8" NPT
05932-480	.480"	.360"	5/8"

axial compensation = 10mm

Precision ER Rigid Tap Collets Inch Sizes



Features

- Replaces expensive tap holders
- Reduce tapping clearance requirements
- Special design locks square in slots

Compatible with ER, DR, RD, ESX, BR or DIN 6499 collet pockets.

For best results use with a PowerCOAT nut to increase clamping pressure up to 75%. See page 62.

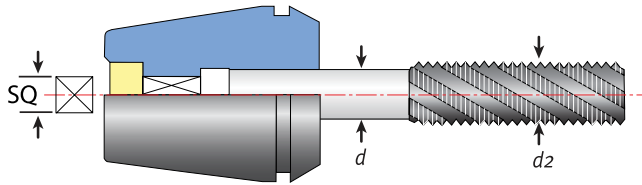

Rigid Tap Collet Sets

Part No.	Description
05320-5(SET)	5 piece ER16 set
05320-9(SET)	9 piece ER16 set
05410-9(SET)	9 piece ER20 set
05510-11(SET)	11 piece ER25 set
05570-16(SET)	16 piece ER32 set
05710-21(SET)	21 piece ER40 set

ER16 Rigid Tap Collets

Part No.	d	SQ	Tap Size (d2)
05320-141	.141"	.110"	1/8" or #6
05320-168	.168"	.131"	5/32" or #8
05320-194	.194"	.152"	3/16" or #10
05320-220	.220"	.165"	7/32" or #12
05320-255	.255"	.191"	1/4"
05320-318	.318"	.238"	5/16"
05320-323	.323"	.242"	7/16"
05320-367	.367"	.275"	1/2"
05320-381	.381"	.286"	3/8"

ER20 Rigid Tap Collets

Part No.	d	SQ	Tap Size (d2)
05410-141	.141"	.110"	1/8" or #6
05410-168	.168"	.131"	5/32" or #8
05410-194	.194"	.152"	3/16" or #10
05410-220	.220"	.165"	7/32" or #12
05410-255	.255"	.191"	1/4"
05410-318	.318"	.238"	5/16"
05410-323	.323"	.242"	7/16"
05410-367	.367"	.275"	1/2"
05410-381	.381"	.286"	3/8"

ER25 Rigid Tap Collets

Part No.	d	SQ	Tap Size (d2)
05510-141	.141"	.110"	1/8" or #6
05510-168	.168"	.131"	5/32" or #8
05510-194	.194"	.152"	3/16" or #10
05510-220	.220"	.165"	7/32" or #12
05510-255	.255"	.191"	1/4"
05510-318	.318"	.238"	5/16"
05510-323	.323"	.242"	7/16"
05510-367	.367"	.275"	1/2"
05510-381	.381"	.286"	3/8"
05510-429	.429"	.322"	9/16"
05510-437	.437"	.328"	1/8" NPT
05510-480	.480"	.360"	5/8"
05510-542	.542"	.406"	11/16"

ER32 Rigid Tap Collets

Part No.	d	SQ	Tap Size (d2)
05570-141	.141"	.110"	1/8" or #6
05570-168	.168"	.131"	5/32" or #8
05570-194	.194"	.152"	3/16" or #10
05570-220	.220"	.165"	7/32" or #12
05570-255	.255"	.191"	1/4"
05570-318	.318"	.238"	5/16"
05570-323	.323"	.242"	7/16"
05570-367	.367"	.275"	1/2"
05570-381	.381"	.286"	3/8"
05570-429	.429"	.322"	9/16"
05570-437	.437"	.328"	1/8" NPT
05570-480	.480"	.360"	5/8"
05570-542	.542"	.406"	11/16"
05570-562	.562"	.421"	1/4" NPT
05570-590	.590"	.442"	3/4"
05570-652	.652"	.489"	13/16"

ER40 Rigid Tap Collets

Part No.	d	SQ	Tap Size (d2)
05710-141	.141"	.110"	1/8" or #6
05710-168	.168"	.131"	5/32" or #8
05710-194	.194"	.152"	3/16" or #10
05710-220	.220"	.165"	7/32" or #12
05710-255	.255"	.191"	1/4"
05710-318	.318"	.238"	5/16"
05710-323	.323"	.242"	7/16"
05710-367	.367"	.275"	1/2"
05710-381	.381"	.286"	3/8"
05710-429	.429"	.322"	9/16"
05710-437	.437"	.328"	1/8" NPT
05710-480	.480"	.360"	5/8"
05710-542	.542"	.406"	11/16"
05710-562	.562"	.421"	1/4" NPT
05710-590	.590"	.442"	3/4"
05710-652	.652"	.489"	13/16"
05710-687	.687"	.515"	1/2" NPT
05710-697	.697"	.523"	7/8"
05710-700	.700"	.531"	3/8" NPT
05710-760	.760"	.570"	15/16"
05710-800	.800"	.600"	1"

Precision ER Rigid Tap Collets Metric Sizes



Features

- Replaces expensive tap holders
- Reduce tapping clearance requirements
- Special design locks square in slots

Compatible with ER, DR, RD, ESX, BR or DIN 6499 collet pockets.

For best results use with a PowerCOAT nut to increase clamping pressure up to 75%. See page 62.



Nuts
pg. 62



Coolant
Rings
pg. 64



Retention
Knobs
pg. 200



Wrenches
pg. 204

ER16 Rigid Tap Collets

Part No.	d	SQ	Tap Size (d2)
05326-DIN	2.8	2.1	
05330-DIN	3.5	2.7	M3
05336-DIN	4.5	3.4	M4
05342-DIN	6	4.9	M5/M6
05350-DIN	8	6.2	M8
05352	8.5	6.5	M12
05354-DIN	9	7	M12
05356-DIN	10	8	M10
05371	6	4.5	M6
05385	6.2	5	M8

Dimensions in mm.

ER20 Rigid Tap Collets

Part No.	d	SQ	Tap Size (d2)
05428-DIN	4.5	3.4	M4
05434-DIN	6	4.9	M5/M6
05436	6.2	5	M7/M8
05442-DIN	8	6.2	M8
05446-DIN	9	7	M12
05448-DIN	10	8	M10
05456-DIN	12	9	M16

ER25 Rigid Tap Collets

Part No.	d	SQ	Tap Size (d2)
05526-DIN	4.5	3.4	M4
05534-DIN	6	4.9	M5/M6
05540-DIN	7	5.5	M10
05542-DIN	8	6.2	M8
05548-DIN	9	7	M12
05550	10	8	M10
05550-DIN	10	8	M10
05554-DIN	11	9	M14
05558-DIN	12	9	M16

Dimensions in mm.

ER32 Rigid Tap Collets

Part No.	d	SQ	Tap Size (d2)
05586-DIN	4.5	3.4	M4
05598-M9	7	5.5	M9
05600-DIN	8	6.2	M8
05600-JIS	8	6	M11
05604-DIN	9	7	M12
05606-DIN	10	8	M10
05610	11	9	M14
05614-DIN	12	9	M16
05620-DIN	14	11	M18
05624-DIN	16	12	M20
05633	20	15	M27

Dimensions in mm.

Precision ER Quick-Change Rigid Tap Collets



Features

- Quick-Change taps in seconds
- Replaces expensive tap holders
- Locking feature prevents spinning the tap
- Reduce tapping clearance requirements

Compatible with these standard collet chucks:
ER, DR, RD, ESX, BR or DIN 6499 collet pockets.

For best tapping performance use with Techniks PowerCOAT nut for highest holding power and accuracy. See page 62.

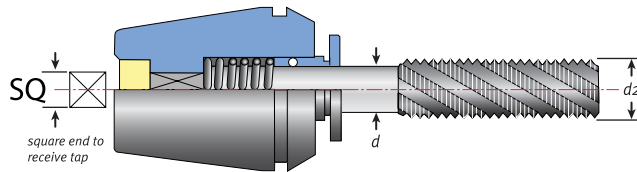

Nuts
pg. 62



Coolant
Rings
pg. 64



Retention
Knobs
pg. 200



Wrenches
pg. 204

Quick-Change Tap Collet Sets

Part No.	Description
05802-4(SET)	4 piece collet set
05804-8(SET)	8 piece collet set
0580611IS	11 piece collet set
05808-15(SET)	15 piece collet set

ER16 Quick-Change Rigid Tap

Part No.	d	SQ	Tap Size (d2)
05802-168	.168"	.131"	5/32" or #8
05802-194	.194"	.152"	3/16" or #10
05802-220	.220"	.165"	7/32" or #12
05802-255	.255"	.191"	1/4"

ER20 Quick-Change Rigid Tap

Part No.	d	SQ	Tap Size (d2)
05804-168	.168"	.131"	5/32" or #8
05804-194	.194"	.152"	3/16" or #10
05804-220	.220"	.165"	7/32" or #12
05804-255	.255"	.191"	1/4"
05804-318	.318"	.238"	5/16"
05804-323	.323"	.242"	7/16"
05804-367	.367"	.275"	1/2"
05804-381	.381"	.286"	3/8"

ER25 Quick-Change Rigid Tap

Part No.	d	SQ	Tap Size (d2)
05806-168	.168"	.131"	5/32" or #8
05806-194	.194"	.152"	3/16" or #10
05806-220	.220"	.165"	7/32" or #12
05806-255	.255"	.191"	1/4"
05806-318	.318"	.238"	5/16"
05806-323	.323"	.242"	7/16"
05806-367	.367"	.275"	1/2"
05806-381	.381"	.286"	3/8"
05806-429	.429"	.322"	9/16"
05806-437	.437"	.328"	1/8" NPT
05806-480	.480"	.360"	5/8"

ER32 Quick-Change Rigid Tap

Part No.	d	SQ	Tap Size (d2)
05808-168	.168"	.131"	5/32" or #8
05808-194	.194"	.152"	3/16" or #10
05808-220	.220"	.165"	7/32" or #12
05808-255	.255"	.191"	1/4"
05808-318	.318"	.238"	5/16"
05808-323	.323"	.242"	7/16"
05808-367	.367"	.275"	1/2"
05808-381	.381"	.286"	3/8"
05808-429	.429"	.322"	9/16"
05808-437	.437"	.328"	1/8" NPT
05808-480	.480"	.360"	5/8"
05808-542	.542"	.406"	11/16"
05808-562	.562"	.421"	1/4" NPT
05808-590	.590"	.442"	3/4"
05808-652	.652"	.489"	13/16"

Collet Storage Trays



Features

- Prevent accidental damage to collets
- Keep collets organized and ready to use
- Exact fit for all your collets

ER Collet Storage Trays

Part No.	Description
04282	ER8 wood Tray - 9 pcs.
04284	ER11 wood tray - 13 pcs.
04286	ER16 wood tray - 10 pcs.
04286-12	ER16 wood tray - 12 pcs.
04288	ER20 wood tray - 12 pcs.
04290	ER25 wood tray - 16 pcs.
04292	ER32 wood tray - 18 pcs.
04292-22	ER32 wood tray - 22 pcs.
04294	ER40 wood tray - 24 pcs.
04294-13	ER40 wood tray - 13 pcs.
04296	ER50 wood tray - 12 pcs.

DA Collet Storage Trays

Part No.	Description
04448	DA100 wood tray - 33 pcs
04449	DA100 wood tray - 8 pcs.
04450	DA100 wood tray - 15 pcs.
04451	DA100 wood tray - 21 pcs.
04452	DA100 wood tray - 29 pcs.
04453	DA180 wood tray - 9 pcs.
04454	DA180 wood tray - 17 pcs.
04455	DA180 wood tray - 21 pcs.
04456	DA180 wood tray - 33 pcs.
04457	DA180 wood tray - 41 pcs.
04459	DA200 wood tray - 9 pcs.
04460	DA200 wood tray - 21 pcs.
04461	DA200 wood tray - 17 pcs.
04462	DA300 wood tray - 7 pcs.
04464	DA300 wood tray - 14 pcs.

TG Collet Storage Trays

Part No.	Description
04466	TG75 wood tray - 11 pcs.
04468	TG75 wood tray - 22 pcs.
04470	TG75 wood tray - 43 pcs.
04472	TG100 wood tray - 15 pcs.
04474	TG100 wood tray - 21 pcs.
04476	TG100 wood tray - 30 pcs.
04478	TG100 wood tray - 41 pcs.
04480	TG100 wood tray - 59 pcs.
04482	TG150 wood tray - 17 pcs.
04484	TG150 wood tray - 33 pcs.
04486	TG150 wood tray - 65 pcs.

PowerCOAT ER Collet Nuts and Coolant Nuts



Features

- Increases holding power by 75%
- Balanced to 25,000 RPM
- Better rigidity and T.I.R. (runout)

See Torque Chart on page 72.

PowerCOAT ER Collet Nuts

Part No.	Description	D	B	T	Wrench
41111	ER11 PowerCOAT hex nut	19mm	12mm	M14 x 0.75	04608
41116	ER16 PowerCOAT hex nut	27.5mm	18mm	M22 x 1.5	04609
41120	ER20 PowerCOAT hex nut	34mm	19mm	M25 x 1.5	04610
41916	ER16 PowerCOAT slot nut	32mm	18mm	M22 x 1.5	04613
41920	ER20 PowerCOAT slot nut	35mm	19.5mm	M25 x 1.5	04614
41925	ER25 PowerCOAT slot nut	42mm	21mm	M32 x 1.5	04615
41932	ER32 PowerCOAT slot nut	50mm	23mm	M40 x 1.5	04616
41940	ER40 PowerCOAT slot nut	63mm	26mm	M50 x 1.5	04617
41950	ER50 PowerCOAT slot nut	78mm	35mm	M64 x 2.0	04618

PowerCOAT Ultra High-Speed ER Nuts (balanced up to 70,000 RPM)

Part No.	Description	D	B	T	Wrench
46111	ER11 high speed hex nut	19mm	11.8mm	M14 x 0.75	04608
46116	ER16 high speed slot nut	27.5mm	18.0mm	M22 x 1.5	04613
46120	ER20 high speed slot nut	35mm	19.5mm	M25 x 1.5	04614
46125	ER25 high speed slot nut	42mm	20.5mm	M32 x 1.5	04615
46132	ER32 high speed slot nut	50mm	23.0mm	M40 x 1.5	04616
46140	ER40 high speed slot nut	63mm	26.0mm	M50 x 1.5	04617



Features

- Increases holding power by 75%
- Seals up to 1,500 P.S.I.
- Balanced to 25,000 RPM
- Use with coolant rings pg. 64

PowerCOAT ER Coolant Nuts

Part No.	Description	D	B	T	Wrench
41616	ER16 coolant slot nut	32	22.5	M22x1.5	04613
41620	ER20 coolant slot nut	35	24	M25x1.5	04614
41625	ER25 coolant slot nut	42	25	M32x1.5	04615
41632	ER32 coolant slot nut	50	27.5	M40x1.5	04616
41640	ER40 coolant slot nut	63	30.7	M50x1.5	04617

Holding Power Testing – ft/lbs

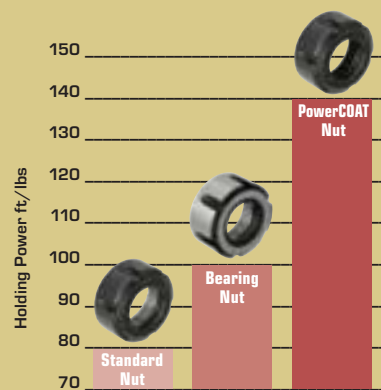

Each nut was tightened to 70 ft/lbs recommended torque before break-free testing of holding power.

Watch the Holding Power testing video at:

www.techniksusa.com/pcnut

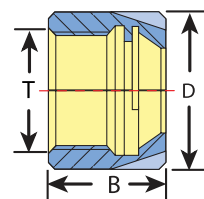

For best performance use a torque wrench and tighten nut to proper torque specification. Snap collet into nut before assembly.

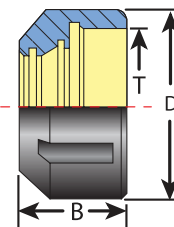

Coolant ring snaps into the nut to seal the tool shank. (pg. 64)
For coolant-thru tools.

PowerCOAT ER Mini Nuts and Bearing Nuts



ER Mini Nut

Features

- For minimum nose O.D. applications
- Increases holding power by 75%
- High speed nuts balanced to 20,000 RPM



Collets
pg. 48



Nuts
pg. 62



Coolant
Rings
pg. 64



Wrenches
pg. 204



Tightening
Stands
pg. 206

ER High Speed Mini Nuts (balanced to 20,000 RPM at G2.5)

Part No.	Description	D	B	T	Wrench
33108	ER8 high speed mini nut	12mm	11mm	M10 x 0.75	04620
33111	ER11 high speed mini nut	16mm	12mm	M13 x 0.75	04621
33116	ER16 high speed mini nut	22mm	18mm	M19 x 1.0	04622
33120	ER20 high speed mini nut	28mm	19.5mm	M24 x 1.0	04623
33125	ER25 high speed mini nut	35mm	21mm	M30 x 1.0	04624
33125-L	ER25 h.s. left-hand mini nut	35mm	21mm	M30 x 1.0	04624

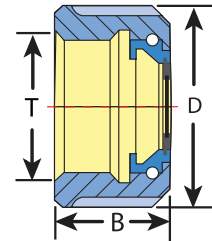

ER Mini Nuts (balanced to 10,000 RPM at G2.5)

Part No.	Description	D	B	T	Wrench
23108	ER8 mini nut	12mm	11mm	M10 x 0.75	04620
23111	ER11 mini nut	16mm	12mm	M13 x 0.75	04621
23116	ER16 mini nut	22mm	18mm	M19 x 1.0	04622
23120	ER20 mini nut	28mm	19.5mm	M24 x 1.0	04623
23125	ER25 mini nut	35mm	21mm	M30 x 1.0	04624

ER Mini Coolant Nuts (balanced to 10,000 RPM at G2.5)

Part No.	Description	Ring	D	B	T	Wrench
23616	ER16 mini coolant nut	ER16	22mm	24mm	M19 x 1.0	04622
23620	ER20 mini coolant nut	ER20	28mm	24mm	M24 x 1.0	04623
23625	ER25 mini coolant nut	ER25	35mm	26.5mm	M30 x 1.0	04624



Coolant Style Mini nut uses ER coolant rings (page 64)



Features

- Increases holding power by 75%
- Balanced to 18,000 RPMs
- Snap collet into nut before assembly

See Torque Chart on page 72.

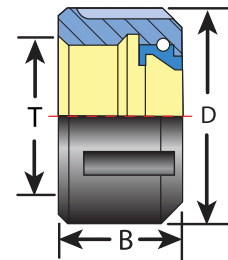

PowerCOAT Bearing Nuts

Part No.	Description	D	B	T	Wrench
29116	ER16 high speed bearing nut	27.5mm	18mm	M22x1.5	04609
29132	ER32 high speed bearing nut	50mm	25mm	M40x1.5	04616

Note: Use a torque wrench and tighten nut to proper torque specification. Do not over tighten these nuts. Snap collet into nut before assembly.

Black Gold ER Coolant Rings



Snap ring into nut before ER collet

Features

- Seals up to 1,500 P.S.I.
- Use with ER collets
- Use with PowerCOAT coolant nuts



PowerCOAT coolant nuts pg. 62

Black Gold ER16 Coolant Rings

Part No.	Shank mm	Shank inch
08516-03.5	3.5 – 3.0mm	1/8"
08516-04.0	4.0 – 3.5mm	5/32"
08516-04.5	4.5 – 4.0mm	11/64"
08516-05.0	5.0 – 4.5mm	3/16"
08516-05.5	5.5 – 5.0mm	13/64"
08516-06.0	6.0 – 5.5mm	7/32"
08516-06.5	6.5 – 6.0mm	1/4"
08516-07.0	7.0 – 6.5mm	17/64"
08516-07.5	7.5 – 7.0mm	9/32"
08516-08.0	8.0 – 7.5mm	5/16"
08516-08.5	8.5 – 8.0mm	21/64"
08516-09.0	9.0 – 8.5mm	11/32"
08516-09.5	9.5 – 9.0mm	3/8"
08516-10.0	10.0 – 9.5mm	25/64"

Black Gold ER20 Coolant Rings

Part No.	Shank mm	Shank inch
08520-03.5	3.5 – 3.0mm	1/8"
08520-04.0	4.0 – 3.5mm	5/32"
08520-04.5	4.5 – 4.0mm	11/64"
08520-05.0	5.0 – 4.5mm	3/16"
08520-05.5	5.5 – 5.0mm	13/64"
08520-06.0	6.0 – 5.5mm	7/32"
08520-06.5	6.5 – 6.0mm	1/4"
08520-07.0	7.0 – 6.5mm	17/64"
08520-07.5	7.5 – 7.0mm	9/32"
08520-08.0	8.0 – 7.5mm	5/16"
08520-08.5	8.5 – 8.0mm	21/64"
08520-09.0	9.0 – 8.5mm	11/32"
08520-09.5	9.5 – 9.0mm	3/8"
08520-10.0	10.0 – 9.5mm	25/64"
08520-10.5	10.5 – 10.0mm	13/32"
08520-11.0	11.0 – 10.5mm	27/64"
08520-11.5	11.5 – 11.0mm	7/16"
08520-12.0	12.0 – 11.5mm	15/32"
08520-12.5	12.5 – 12.0mm	31/64"
08520-13.0	13.0 – 12.5mm	1/2"

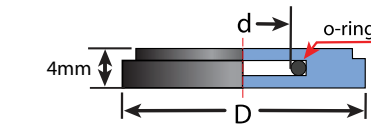

Dimensions	D
ER16	12.9 mm
ER20	15.9 mm
ER25	21 mm
ER32	26.95 mm
ER40	33.3 mm

Black Gold ER25 Coolant Rings

Part No.	Shank mm	Shank inch
08525-03.5	3.5 – 3.0mm	1/8"
08525-04.0	4.0 – 3.5mm	5/32"
08525-04.5	4.5 – 4.0mm	11/64"
08525-05.0	5.0 – 4.5mm	3/16"
08525-05.5	5.5 – 5.0mm	13/64"
08525-06.0	6.0 – 5.5mm	7/32"
08525-06.5	6.5 – 6.0mm	1/4"
08525-07.0	7.0 – 6.5mm	17/64"
08525-07.5	7.5 – 7.0mm	9/32"
08525-08.0	8.0 – 7.5mm	5/16"
08525-08.5	8.5 – 8.0mm	21/64"
08525-09.0	9.0 – 8.5mm	11/32"
08525-09.5	9.5 – 9.0mm	3/8"
08525-10.0	10.0 – 9.5mm	25/64"
08525-10.5	10.5 – 10.0mm	13/32"
08525-11.0	11.0 – 10.5mm	27/64"
08525-11.5	11.5 – 11.0mm	7/16"
08525-12.0	12.0 – 11.5mm	15/32"
08525-12.5	12.5 – 12.0mm	31/64"
08525-13.0	13.0 – 12.5mm	1/2"
08525-13.5	13.5 – 13.0mm	17/32"
08525-14.0	14.0 – 13.5mm	35/64"
08525-14.5	14.5 – 14.0mm	9/16"
08525-15.0	15.0 – 14.5mm	37/64"
08525-15.5	15.5 – 15.0mm	19/32"
08525-16.0	16.0 – 15.5mm	5/8"

NOTE: Remove o-ring for coolant surround tool applications using non-coolant cutting tools. (see photos pg. 53)

Black Gold ER32 TG100 Coolant Rings

Part No.	Shank mm	Shank inch
08532-03.5	3.5 – 3.0mm	1/8"
08532-04.0	4.0 – 3.5mm	5/32"
08532-04.5	4.5 – 4.0mm	11/64"
08532-05.0	5.0 – 4.5mm	3/16"
08532-05.5	5.5 – 5.0mm	13/64"
08532-06.0	6.0 – 5.5mm	7/32"
08532-06.5	6.5 – 6.0mm	1/4"
08532-07.0	7.0 – 6.5mm	17/64"
08532-07.5	7.5 – 7.0mm	9/32"
08532-08.0	8.0 – 7.5mm	5/16"
08532-08.5	8.5 – 8.0mm	21/64"
08532-09.0	9.0 – 8.5mm	11/32"
08532-09.5	9.5 – 9.0mm	3/8"
08532-10.0	10.0 – 9.5mm	25/64"
08532-10.5	10.5 – 10.0mm	13/32"
08532-11.0	11.0 – 10.5mm	27/64"
08532-11.5	11.5 – 11.0mm	7/16"
08532-12.0	12.0 – 11.5mm	15/32"
08532-12.5	12.5 – 12.0mm	31/64"
08532-13.0	13.0 – 12.5mm	1/2"
08532-13.5	13.5 – 13.0mm	17/32"
08532-14.0	14.0 – 13.5mm	35/64"
08532-14.5	14.5 – 14.0mm	9/16"
08532-15.0	15.0 – 14.5mm	37/64"
08532-15.5	15.5 – 15.0mm	19/32"
08532-16.0	16.0 – 15.5mm	5/8"
08532-16.5	16.5 – 16.0mm	41/64"
08532-17.0	17.0 – 16.5mm	21/32"
08532-17.5	17.5 – 17.0mm	11/16"
08532-18.0	18.0 – 17.5mm	45/64"
08532-18.5	18.5 – 18.0mm	23/32"
08532-19.0	19.0 – 18.5mm	3/4"
08532-19.5	19.5 – 19.0mm	49/64"
08532-20.0	20.0 – 19.5mm	25/32"

Black Gold ER Coolant Rings



Turn your collet chuck into a CoolBLAST holder

Use ER Coolant Rings without "o" ring for CoolBLAST coolant application.



Use ER Coolant Rings with "o" ring for coolant-thru tool.

ER coolant rings are great for unattended operation - there are no rubber seals to blow out under high pressure.

Cost Study Over 4 Year Period

	ER32 Coolant Collet	ER32 Coolant Ring System
Cost of 320 collets	\$16,000.00	\$8,640.00
Cost of 20 nuts	\$ 0.00 (come with holders)	\$1,300.00 (includes rings)
Total 4 year cost	\$16,000.00	\$9,940.00

\$6,060.00 savings

Figures based on 20 toolholders, allowing 4 collets a year for each toolholder for a total of 320 collets, plus one nut for each toolholder over the four year period.

Black Gold ER40 Coolant Rings

Part No.	Shank mm	Shank inch
08540-03.5	3.5 – 3.0mm	1/8"
08540-04.0	4.0 – 3.5mm	5/32"
08540-04.5	4.5 – 4.0mm	11/64"
08540-05.0	5.0 – 4.5mm	3/16"
08540-05.5	5.5 – 5.0mm	13/64"
08540-06.0	6.0 – 5.5mm	7/32"
08540-06.5	6.5 – 6.0mm	1/4"
08540-07.0	7.0 – 6.5mm	17/64"
08540-07.5	7.5 – 7.0mm	9/32"
08540-08.0	8.0 – 7.5mm	5/16"
08540-08.5	8.5 – 8.0mm	21/64"
08540-09.0	9.0 – 8.5mm	11/32"
08540-09.5	9.5 – 9.0mm	3/8"
08540-10.0	10.0 – 9.5mm	25/64"
08540-10.5	10.5 – 10.0mm	13/32"

Part No.	Shank mm	Shank inch
08540-11.0	11.0 – 10.5mm	27/64"
08540-11.5	11.5 – 11.0mm	7/16"
08540-12.0	12.0 – 11.5mm	15/32"
08540-12.5	12.5 – 12.0mm	31/64"
08540-13.0	13.0 – 12.5mm	1/2"
08540-13.5	13.5 – 13.0mm	17/32"
08540-14.0	14.0 – 13.5mm	35/64"
08540-14.5	14.5 – 14.0mm	9/16"
08540-15.0	15.0 – 14.5mm	37/64"
08540-15.5	15.5 – 15.0mm	19/32"
08540-16.0	16.0 – 15.5mm	5/8"
08540-16.5	16.5 – 16.0mm	41/64"
08540-17.0	17.0 – 16.5mm	21/32"
08540-17.5	17.5 – 17.0mm	11/16"
08540-18.0	18.0 – 17.5mm	45/64"
08540-18.5	18.5 – 18.0mm	23/32"

ER Coolant Ring Sets

Part No.	Description
08516-14(SET)	14 piece ER16 coolant ring set
08520-20(SET)	20 piece ER20 coolant ring set
08525-26(SET)	26 piece ER25 coolant ring set
08532-34(SET)	34 piece ER32 coolant ring set
08540-46(SET)	46 piece ER40 coolant ring set

Part No.	Shank mm	Shank inch
08540-19.0	19.0 – 18.5mm	3/4"
08540-19.5	19.5 – 19.0mm	49/64"
08540-20.0	20.0 – 19.5mm	25/32"
08540-20.5	20.5 – 20.0mm	51/64"
08540-21.0	21.0 – 20.5mm	13/16"
08540-21.5	21.5 – 21.0mm	27/32"
08540-22.0	22.0 – 21.5mm	55/64"
08540-22.5	22.5 – 22.0mm	7/8"
08540-23.0	23.0 – 22.5mm	29/32"
08540-23.5	23.5 – 23.0mm	59/64"
08540-24.0	24.0 – 23.5mm	15/16"
08540-24.5	24.5 – 24.0mm	61/64"
08540-25.0	25.0 – 24.5mm	31/32"
08540-25.5	25.5 – 25.0mm	1.0"
08540-26.0	26.0 – 25.5mm	1 1/64"



All Techniks products are backed by our 100% satisfaction guarantee!

Precision TG75 Collets and PowerCOAT Nut



Features

- .0004" T.I.R.
- Precision ground & hand inspected
- Clamping range: 1/64"



Dimensions

Series	L	A
TG75	1.844"	1.062"

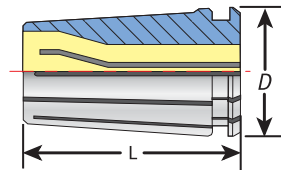

TG75 Sets

Part No.	Pieces	ID Sizes
04008-43S	43	1/8" - 3/4" by 64ths
04008-22S	22	1/8" - 3/4" by 32nds
04008-11S	11	1/8" - 3/4" by 16ths

TG75 Collets

Part No.	Shank	Part No.	Shank	Part No.	Shank	Part No.	Shank
04008-3/32	3/32"	04008-17/64	17/64"	04008-7/16	7/16"	04008-39/64	39/64"
04008-7/64	7/64"	04008-9/32	9/32"	04008-29/64	29/64"	04008-5/8	5/8"
04008-1/8	1/8"	04008-19/64	19/64"	04008-15/32	15/32"	04008-41/64	41/64"
04008-9/64	9/64"	04008-5/16	5/16"	04008-31/64	31/64"	04008-21/32	21/32"
04008-5/32	5/32"	04008-21/64	21/64"	04008-1/2	1/2"	04008-43/64	43/64"
04008-11/64	11/64"	04008-11/32	11/32"	04008-33/64	33/64"	04008-11/16	11/16"
04008-3/16	3/16"	04008-23/64	23/64"	04008-17/32	17/32"	04008-45/64	45/64"
04008-13/64	13/64"	04008-3/8	3/8"	04008-35/64	35/64"	04008-23/32	23/32"
04008-7/32	7/32"	04008-25/64	25/64"	04008-9/16	9/16"	04008-47/64	47/64"
04008-15/64	15/64"	04008-13/32	13/32"	04008-37/64	37/64"	04008-3/4	3/4"
04008-1/4	1/4"	04008-27/64	27/64"	04008-19/32	19/32"		



Features

- Increases holding power by 75%
- Balanced to 25,000 RPM
- Better rigidity and less T.I.R. (runout)

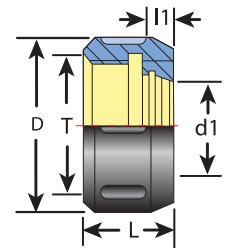

TG75 PowerCOAT Collet Nut

Part No.	Description	D	d1	T	I1	L	Wrench	Torque
84012	TG75 Collet Nut	1.88"	-	1 1/2 - 12"	0.32"	0.94"	04616	90 ft/lb

Precision TG100 Collets and PowerCOAT Nut

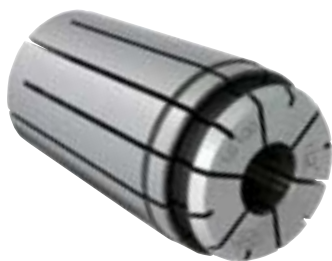

Features

- .0004" T.I.R.
- Precision ground & hand inspected
- Clamping range: 1/64"
- Metric sizes in stock



Dimensions

Series	L	A
TG100	2.375"	1.379"

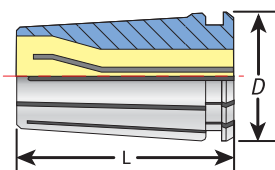

TG100 Sets

Part No.	Pcs.	ID Sizes
04010-59S	59	3/32 - 1" by 64ths
04010-41S	41	3/8 - 1" by 64ths
04010-30S	30	3/32 - 1" by 32nds
04010-21S	21	3/8 - 1" by 32nds
04010-15S	15	1/8 - 1" by 16ths

TG100 Collets

Part No.	Shank	Part No.	Shank	Part No.	Shank	Part No.	Shank
04010-3/32	3/32"	04010-21/64	21/64"	04010-9/16	9/16"	04010-51/64	51/64"
04010-7/64	7/64"	04010-11/32	11/32"	04010-37/64	37/64"	04010-13/16	13/16"
04010-1/8	1/8"	04010-23/64	23/64"	04010-19/32	19/32"	04010-53/64	53/64"
04010-9/64	9/64"	04010-3/8	3/8"	04010-39/64	39/64"	04010-27/32	27/32"
04010-5/32	5/32"	04010-25/64	25/64"	04010-5/8	5/8"	04010-55/64	55/64"
04010-11/64	11/64"	04010-13/32	13/32"	04010-41/64	41/64"	04010-7/8	7/8"
04010-3/16	3/16"	04010-27/64	27/64"	04010-21/32	21/32"	04010-57/64	57/64"
04010-13/64	13/64"	04010-7/16	7/16"	04010-43/64	43/64"	04010-29/32	29/32"
04010-7/32	7/32"	04010-29/64	29/64"	04010-11/16	11/16"	04010-59/64	59/64"
04010-15/64	15/64"	04010-15/32	15/32"	04010-45/64	45/64"	04010-15/16	15/16"
04010-1/4	1/4"	04010-31/64	31/64"	04010-23/32	23/32"	04010-61/64	61/64"
04010-17/64	17/64"	04010-1/2	1/2"	04010-47/64	47/64"	04010-31/32	31/32"
04010-9/32	9/32"	04010-33/64	33/64"	04010-3/4	3/4"	04010-63/64	63/64"
04010-19/64	19/64"	04010-17/32	17/32"	04010-49/64	49/64"	04010-1	1.0"
04010-5/16	5/16"	04010-35/64	35/64"	04010-25/32	25/32"		



Features

- Increases holding power by 75%
- Balanced to 25,000 RPM
- Better rigidity and less T.I.R. (runout) increase cutting tool life

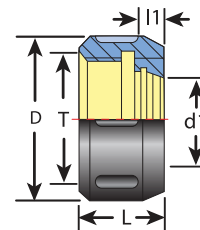

TG100 PowerCOAT Nuts

Part No.	Description	D	d1	T	I1	L	Spanner	Torque
28110	TG100 Collet Nut	2.35"	1.12"	1 7/8 - 12"	0.44"	1.18"	03691	90 ft/lb

Precision TG100 Coolant Collets and PowerCOAT Nut



Features

- Up to 750 PSI coolant
- .0004" T.I.R.
- Clamping range: 1/64"

Use with TG PowerCOAT Nut



Nuts
pg. 62



Coolant
Rings
pg. 64



Retention
Knobs
pg. 200



Wrenches
pg. 204



Dimensions

Series	L	A
TG100	2.375"	1.379"

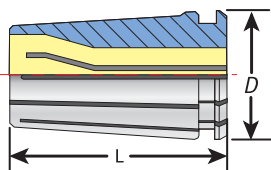

TG100 Coolant Collet Sets

Part No.	Pcs.	ID Sizes
84063-25(SET)	25	1/4" - 1.0" by 64ths

TG100 Coolant Collets

Part No.	Shank Size	Part No.	Shank Size	Part No.	Shank Size	Part No.	Shank Size
84063-1/4	1/4"	84063-7/16	7/16"	84063-5/8	5/8"	84063-13/16	13/16"
84063-9/32	9/32"	84063-15/32	15/32"	84063-21/32	21/32"	84063-27/32	27/32"
84063-5/16	5/16"	84063-1/2	1/2"	84063-11/16	11/16"	84063-7/8	7/8"
84063-11/32	11/32"	84063-17/32	17/32"	84063-23/32	23/32"	84063-29/32	29/32"
84063-3/8	3/8"	84063-9/16	9/16"	84063-3/4	3/4"	84063-15/16	15/16"
84063-13/32	13/32"	84063-19/32	19/32"	84063-25/32	25/32"	84063-31/32	31/32"
						84063-1	1.0"



Use with ER coolant rings
page 64.

Features

- Works with TG100 collets
- Up to 1,500 PSI coolant
- Increases holding power by 75%



ER32 coolant ring snaps into the
nut to seal the tool shank.

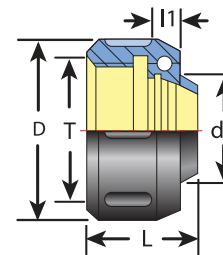

TG100 Coolant Nuts

Part No.	Description	D	d1	T	I1	L	Wrench	Torque
28210	TG100 Coolant Nut	2.35"	0.95"	1 7/8 - 12"	0.44"	1.41"	03691	90 ft/lb

Precision TG150 Collets and Collet Sets



Features

- .0004" T.I.R.
- Precision ground & hand inspected
- Clamping range: 1/64"



Dimensions

Series	L	A
TG150	3.0"	2.001"

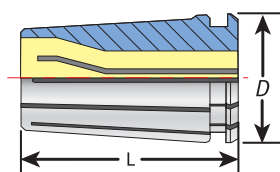

TG150 Collets

Part No.	Shank
04011-17/64	17/64"
04011-3/8	38"
04011-7/32	7/32"
04011-1/2	1/2"
04011-33/64	33/64"
04011-17/32	17/32"
04011-35/64	35/64"
04011-9/16	9/16"
04011-37/64	37/64"
04011-19/32	19/32"
04011-39/64	39/64"
04011-5/8	5/8"
04011-41/64	41/64"
04011-21/32	21/32"
04011-43/64	43/64"
04011-11/16	11/16"
04011-45/64	45/64"

Part No.	Shank
04011-23/32	23/32"
04011-47/64	47/64"
04011-3/4	3/4"
04011-49/64	49/64"
0410-20	20mm
04011-25/32	25/32"
04011-51/64	51/64"
04011-13/16	13/16"
04011-53/64	53/64"
04011-27/32	27/32"
04011-55/64	55/64"
04011-7/8	7/8"
04011-57/64	57/64"
04011-29/32	29/32"
04011-59/64	59/64"
04011-15/16	15/16"
04011-61/64	61/64"

TG150 Sets

Part No.	Pcs.	ID Sizes
04011-65S	65	1/2 - 1 1/2" by 64ths
04011-33S	33	1/2 - 1 1/2" by 32nds
04011-17S	17	1/2 - 1 1/2" by 16ths

Part No.	Shank
04011-31/32	31/32"
04011-63/64	63/64"
04011-1	1.0"
04011-1.1/64	1-1/64"
04011-1.3/64	1-3/64"
04011-1.1/16	1-1/16"
04011-1.5/64	1-5/64"
04011-1.3/32	1-3/32"
04011-1.7/64	1-7/64"
04011-1.1/8	1-1/8"
04011-1.9/64	1-9/64"
04011-1.5/32	1-5/32"
04011-1.11/64	1-11/64"
04011-1.3/16	1-3/16"
04011-1.13/64	1-13/64"
04011-1.7/32	1-7/32"
04011-1.15/64	1-15/64"

Part No.	Shank
04011-1.1/4	1-1/4"
04011-1.17/64	1-17/64"
04011-1.9/32	1-9/32"
04011-1.19/64	1-19/64"
04011-1.5/16	1-5/16"
04011-1.21/64	1-21/64"
04011-1.11/32	1-11/32"
04011-1.23/64	1-23/64"
04011-1.3/8	1-3/8"
04011-1.25/64	1-25/64"
04011-1.13/32	1-13/32"
04011-1.27/64	1-27/64"
04011-1.7/16	1-7/16"
04011-1.29/64	1-29/64"
04011-1.15/32	1-15/32"
04011-1.31/64	1-31/64"
04011-1.1/2	1-1/2"

SYOZ / EOC (DIN 6388) Perske Style Collets and Nuts



Features

- T.I.R. (runout) .0004"
- Collapse range: 1/64"
- Made from high-carbon steel

These collets and collet nuts conform to DIN 6388 standards. Snap collet into the nut before screwing the nut on to the spindle or holder.



Retention Knobs
pg. 200



Wrenches
pg. 204



Tightening Stands
pg. 206

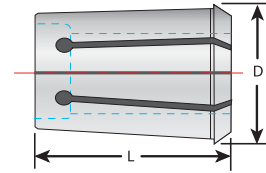

SYOZ20 / EOC 12 Collets

Part No.	Shank Size
83512-1/8	1/8"
83512-3/16	3/16"
83512-1/4	1/4"
83512-5/16	5/16"
83512-3/8	3/8"
83512-7/16	7/16"
83512-1/2	1/2"
83512-10	10mm

SYOZ25 Collets

Part No.	Shank Size
83868-1/8	1/8"
83868-3/16	3/16"
83868-1/4	1/4"
83868-5/16	5/16"
83868-3/8	3/8"
83868-7/16	7/16"
83868-1/2	1/2"
83868-9/16	9/16"
83868-5/8	5/8"
83868-3/4	3/4"
83868-7/8	7/8"
83868-1	1.0"
83868-10	10mm
83868-16	16mm
83868-20	20mm
83868-25	25mm

SYOC / EOC Collet Dimensions

Part No.	L	D
SYOZ20	34mm	20mm
SYOZ25	52mm	35mm
EOC 08	26mm	14.4mm
EOC16	40mm	25.5mm

EOC8 Collets

Part No.	Shank Size
83508-1/8	1/8"
83508-3/16	3/16"
83508-1/4	1/4"
03508-5/16	5/16"

SYOZ20/EOC 12 Collets

Various metric and inch sizes available from stock.

EOC16 Collets

Part No.	Shank Size
83531-1/8	1/8"
83531-3/16	3/16"
83531-1/4	1/4"
83531-5/16	5/16"
83531-3/8	3/8"
83531-7/16	7/16"
83531-1/2	1/2"
83531-9/16	9/16"
83531-5/8	5/8"
83531-10	10mm
83531-16	16mm



DIN 6388 Nuts and Wrenches

Part No.	Description	L	D	Wrench
83508-NUT	EOC08 nut	19	30	-
03636-NUT	EOC16 nut	24	43	03636
83634	SYOZ20/EOC 12 nut	20	35	22220
83634-L	SYOZ20/EOC 12 left-hand nut	20	35	22220
83632	SYOZ25 PowerCOAT nut	30	60	03691

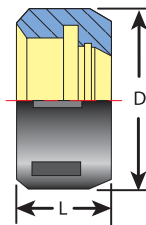

Precision Double Angle (DA) Collets



Features

- Collapse range: 1/64"
- Made from high-carbon steel

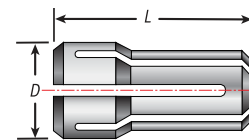

Double Angle Collet Sets

DA180	Description
01618-9S	9pc 1/4 - 3/4" by 16 ^{ths}
01618-17S	17pc 1/4 - 3/4" by 32 ^{nds}
01618-21S	21pc 1/8 - 3/4" by 32 ^{nds}
01618-33S	33pc 1/4 - 3/4" by 64 ^{ths}
01618-41S	41pc 1/8 - 3/4" by 64 ^{ths}

DA100	Description
01610-8S	8pc 1/8 - 9/16" by 16 ^{ths}
01610-15S	15pc 1/8 - 9/16" by 32 ^{nds}
01610-21S	21pc 1/4 - 9/16" by 64 ^{ths}
01610-29S	29pc 1/8 - 9/16" by 64 ^{ths}
01610-33S	33pc 1/16 - 9/16" by 64 ^{ths}

DA200	Description
01620-9S	9pc 1/8 - 3/8" by 32 ^{nds}
01620-17S	17pc 1/8 - 3/8" by 64 ^{ths}
01620-21S	21pc 1/16 - 3/8" by 64 ^{ths}

DA300	Description
01630-7S	7pc 1/16 - 1/4" by 32 ^{nds}
01630-14S	14pc 3/64 - 1/4" by 64 ^{ths}

Dimensions

Series	L	D
DA180	1.625"	1.035"
DA100	1.438"	0.769"
DA200	1.188"	0.531"
DA300	1.000"	0.375"

The last number in the part number indicates the number of collets in the set.

DA180 Collets	Size
01618-1/16	1/16"
01618-5/64	5/64"
01618-3/32	3/32"
01618-7/64	7/64"
01618-1/8	1/8"
01618-9/64	9/64"
01618-5/32	5/32"
01618-11/64	11/64"
01618-3/16	3/16"
01618-13/64	13/64"
01618-7/32	7/32"
01618-15/64	15/64"
01618-1/4	1/4"
01618-17/64	17/64"
01618-9/32	9/32"
01618-19/64	19/64"
01618-5/16	5/16"
01618-21/64	21/64"
01618-11/32	11/32"
01618-23/64	23/64"
01618-3/8	3/8"
01618-25/64	25/64"
01618-13/32	13/32"
01618-27/64	27/64"
01618-7/16	7/16"
01618-29/64	29/64"
01618-15/32	15/32"
01618-31/64	31/64"
01618-1/2	1/2"
01618-33/64	33/64"

DA100 Collets	Size
01610-17/32	17/32"
01610-35/64	35/64"
01610-9/16	9/16"
01610-37/64	37/64"
01610-19/32	19/32"
01610-39/64	39/64"
01610-5/8	5/8"
01610-41/64	41/64"
01610-21/32	21/32"
01610-43/64	43/64"
01610-11/16	11/16"
01610-45/64	45/64"
01610-23/32	23/32"
01610-47/64	47/64"
01610-3/4	3/4"
DA100 Collets	Size
01610-1/16	1/16"
01610-5/64	5/64"
01610-3/32	3/32"
01610-7/64	7/64"
01610-1/8	1/8"
01610-9/64	9/64"
01610-5/32	5/32"
01610-11/64	11/64"
01610-3/16	3/16"
01610-13/64	13/64"
01610-7/32	7/32"
01610-15/64	15/64"
01610-1/4	1/4"

DA100 Collets	Size
01610-17/64	17/64"
01610-9/32	9/32"
01610-19/64	19/64"
01610-5/16	5/16"
01610-21/64	21/64"
01610-11/32	11/32"
01610-23/64	23/64"
01610-3/8	3/8"
01610-25/64	25/64"
01610-13/32	13/32"
01610-27/64	27/64"
01610-7/16	7/16"
01610-29/64	29/64"
01610-15/32	15/32"
01610-31/64	31/64"
01610-1/2	1/2"
01610-33/64	33/64"
01610-17/32	17/32"
01610-35/64	35/64"
01610-9/16	9/16"
DA200 Collets	Size
01620-3/64	3/64"
01620-1/16	1/16"
01620-5/64	5/64"
01620-3/32	3/32"
01620-7/64	7/64"
01620-1/8	1/8"
01620-9/64	9/64"
01620-5/32	5/32"
01620-11/64	11/64"
01620-3/16	3/16"
01620-13/64	13/64"
01620-7/32	7/32"
01620-15/64	15/64"
01620-5/32	5/32"

DA200 Collets	Size
01620-11/64	11/64"
01620-3/16	3/16"
01620-13/64	13/64"
01620-7/32	7/32"
01620-15/64	15/64"
01620-1/4	1/4"
01620-17/64	17/64"
01620-9/32	9/32"
01620-19/64	19/64"
01620-5/16	5/16"
01620-21/64	21/64"
01620-11/32	11/32"
01620-23/64	23/64"
01620-3/8	3/8"
DA300 Collets	Size
01630-3/64	3/64"
01630-1/16	1/16"
01630-5/64	5/64"
01630-3/32	3/32"
01630-7/64	7/64"
01630-1/8	1/8"
01630-9/64	9/64"
01630-5/32	5/32"
01630-11/64	11/64"
01630-3/16	3/16"
01630-13/64	13/64"
01630-7/32	7/32"
01630-15/64	15/64"
01630-1/4	1/4"

CNC Collet Identification and Special Orders Guide

Use the guide below for selecting replacement collets. The best way to tell what type of collet you have is to measure the length of the collet. ER, TG, and SYOZ collets all have unique measurements. For best results always use a PowerCOAT nut tightened to proper specification using an accurate torque wrench.

ER Collet	L	D	Torque Spec
ER8	13mm (.51")	8.5mm (.33")	-
ER11	18mm (.708")	11.5mm (.45")	17 ft/lbs
ER16	27.5mm (1.08")	17mm (.67")	42 ft/lbs
ER20	31.5mm (1.24")	21mm (.83")	59 ft/lbs
ER25	34mm (1.34")	26mm (1.02")	77 ft/lbs
ER32	40mm (1.57")	33mm (1.3")	100 ft/lbs
ER40	46mm (1.81")	41mm (1.61")	119 ft/lbs
ER50	60 mm (2.36")	52mm (2.05")	-

TG Collet	L	D	Torque Spec
TG75	47mm (1.85")	27mm (1.06")	90 ft/lbs
TG100	60mm (2.36")	35mm (1.38")	90 ft/lbs
TG150	76mm (3")	51mm (2")	110 ft/lbs

SYOZ / EOC Collet	L	D
EOC8	26mm (1.026")	14.4mm (.567")
SYOZ20	34mm (1.34")	20mm (.78")
RDO 20	34mm (1.34")	20mm (.78")
407E	34mm (1.34")	20mm (.78")
EOC 12	34mm (1.34")	20mm (.78")
SYOZ25	52mm (2.06")	35mm (1.38")
RDO 35	52mm (2.06")	35mm (1.38")
462E / SYOZ25	52mm (2.06")	35mm (1.38")
EOC 32	60mm (2.36")	43.7mm (1.72")

DA Collet	L	D
DA180	1.625"	1.035"
DA100	1.438"	.769"
DA200	1.188"	.531"
DA300	1.000"	.375"

DNA Collet	L	D
DNA 11	16.9mm (0.67")	11.5mm (0.45")
DNA 16	24mm (0.94")	17mm (0.67")
DNA 20	30.42mm (1.20")	21.10mm (0.83")
DNA 32	40mm (1.57")	33.25mm (1.31")

Special Order Collets Dimensions

Length _____ Diameter _____ Other Markings _____

Length _____ Diameter _____ Other Markings _____

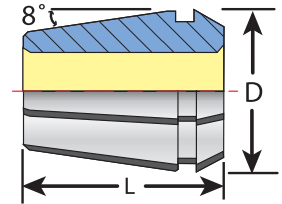

ER Collet Style

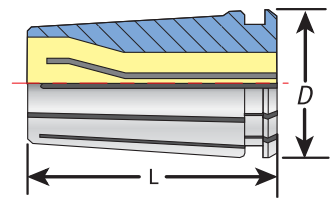

TG Collet Style

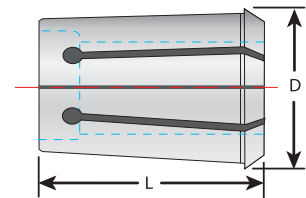

SYOZ Collet Style

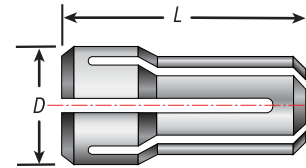

DA Collet Style

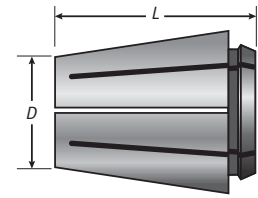

DNA Collet Style

Precision End Mill Holders

Double your tool life or better with our high-precision End Mill holders.

Manufactured to H5 Bore Tolerance

Techniks End Mill holders are the most accurate on the market for improved T.I.R. and extended tool life. (see diagram below)



Three Coolant Style Holders Available

CoolBLAST coolant ports (shown) blast coolant on tool path. CoolFLEX holders are factory set for coolant-thru tool or remove 2 setscrews for DIN B coolant-thru flange.

Others T.I.R. .0008"

Techniks .0002"

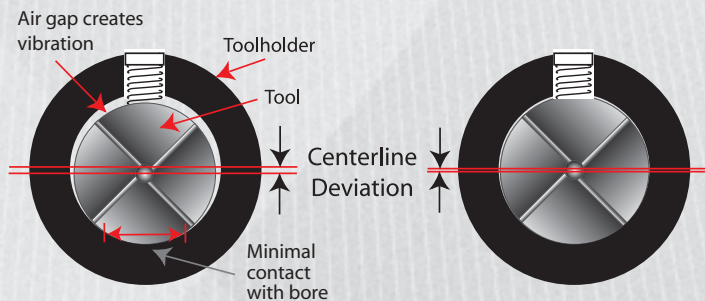

***You lose 10% of tool life for every .0001" of T.I.R.
Techniks End Mill holders are manufactured to an
H5 bore tolerance to extend cutting tool life.***

Built for Speed.

CAT40 Precision End Mill Holders



Techniks Certified for bore and taper tolerances

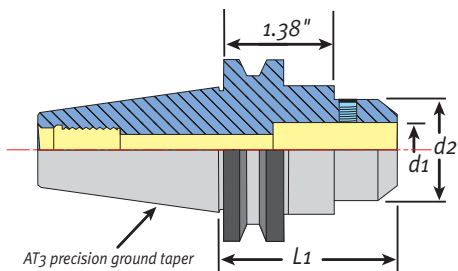

Stubby

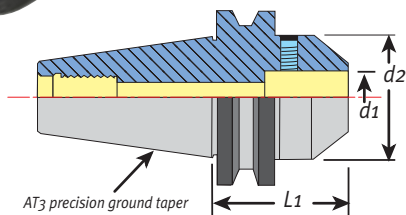

CAT40 Stubby Length End Mill Holders

Part No.	Description	d1	L1	d2
22907-1.75	CAT40 x 1/8" I.D. - 1.75"	1/8"	1.75"	.75"
22909-1.75	CAT40 x 3/16" I.D. - 1.75"	3/16"	1.75"	.79"
22911-1.75	CAT40 x 1/4" I.D. - 1.75"	1/4"	1.75"	.79"
22913-1.75	CAT40 x 5/16" I.D. - 1.75"	5/16"	1.75"	.88"
22915-1.75	CAT40 x 3/8" I.D. - 1.75"	3/8"	1.75"	.88"
22916-1.75	CAT40 x 7/16" I.D. - 1.75"	7/16"	1.75"	1.12"
22917-1.75	CAT40 x 1/2" I.D. - 1.75"	1/2"	1.75"	1.50"
22919-1.75	CAT40 x 5/8" I.D. - 1.75"	5/8"	1.75"	1.50"
22921-1.75	CAT40 x 3/4" I.D. - 1.75"	3/4"	1.75"	1.75"
22925A-1.75	CAT40 x 1.0" I.D. - 1.75"	1.0"	1.75"	2"
22927A-2	CAT40 x 1-1/4" I.D. - 2"	1-1/4"	2"	2.5"

Features

- High precision bore (H5) is best in industry
- Balanced to 10,000 RPM to save spindle bearing life
- Taper ground to AT₃ for maximum spindle contact

CAT40 End Mill Holders Inch Size

Part No.	Description	d1	L1	d2
22907	CAT40 x 1/8" I.D. - 2.37"	1/8"	2.37"	.69"
22909	CAT40 x 3/16" I.D. - 2.5"	3/16"	2.5"	.69"
22911	CAT40 x 1/4" I.D. - 3"	1/4"	3"	.78"
22911-2.5	CAT40 x 1/4" I.D. - 2.5"	1/4"	2.5"	.78"
22913	CAT40 x 5/16" I.D. - 3"	5/16"	3"	.88"
22913-2.5	CAT40 x 5/16" I.D. - 2.5"	5/16"	2.5"	.88"
22915	CAT40 x 3/8" I.D. - 3"	3/8"	3"	1.0"
22915-2.5	CAT40 x 3/8" I.D. - 2.5"	3/8"	2.5"	1.0"
22916-2.5	CAT40 x 7/16" I.D. - 2.5"	7/16"	2.5"	1.13"
22917	CAT40 x 1/2" I.D. - 3"	1/2"	3"	1.25"
22917-2.5	CAT40 x 1/2" I.D. - 2.5"	1/2"	2.5"	1.25"
22917-2.63	CAT40 x 1/2" I.D. - 2.63"	1/2"	2.63"	1.25"
22919	CAT40 x 5/8" I.D. - 3"	5/8"	3"	1.5"
22920	CAT40 x 5/8" I.D. - 3.75"	5/8"	3.75"	1.5"
22921	CAT40 x 3/4" I.D. - 3.5"	3/4"	3.5"	1.75"
22921-3	CAT40 x 3/4" I.D. - 3"	3/4"	3"	1.75"
22923	CAT40 x 7/8" I.D. - 3.5"	7/8"	3.5"	1.88"
22925-3	CAT40 x 1.0" I.D. - 3"	1.0"	3"	2"
22925	CAT40 x 1.0" I.D. - 4"	1.0"	4"	2"
22927	CAT40 x 1.25" I.D. - 4.6"	1.25"	4.6"	2.5"
22927-4	CAT40 x 1.25" I.D. - 4"	1.25"	4"	2.5"
22929	CAT40 x 1.5" I.D. - 4.5"	1.5"	4.5"	2.5"

CAT40 End Mill Holders Metric Size

Part No.	Description	d1	L1	d2
22963	CAT40 x 6mm I.D. - 2.5"	6mm	2.5"	25mm
22965	CAT40 x 8mm I.D. - 2.5"	8mm	2.5"	28mm
22967	CAT40 x 10mm I.D. - 2.5"	10mm	2.5"	35mm
22969	CAT40 x 12mm I.D. - 2.5"	12mm	2.5"	42mm
22971	CAT40 x 16mm I.D. - 2.5"	16mm	2.5"	48mm
22973	CAT40 x 20mm I.D. - 3"	20mm	3"	52mm
22975	CAT40 x 25mm I.D. - 4"	25mm	4"	65mm
22977	CAT40 x 32mm I.D. - 4"	32mm	4"	72mm

CAT40 Precision End Mill Holders



Extended length

Features

- High precision bore (H5) is best in industry
- Balanced to 10,000 RPM to save spindle bearing life
- Taper ground to AT3 for maximum spindle contact



Rigid Reach

Our Rigid Reach End Mill holders are great for machining in tight areas at extended length where tolerance is important. The tapered design improves rigidity and overall cutting performance.

Techniks H5 Bore Tolerance Extends Tool Life 60%

You lose 10% of cutting tool life for every .0001" of T.I.R.

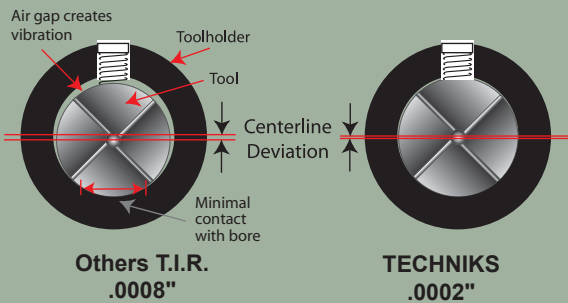

Retention Knobs pg. 200



Lock Screws pg. 89



Wrenches pg. 204



Tightening Stands pg. 206

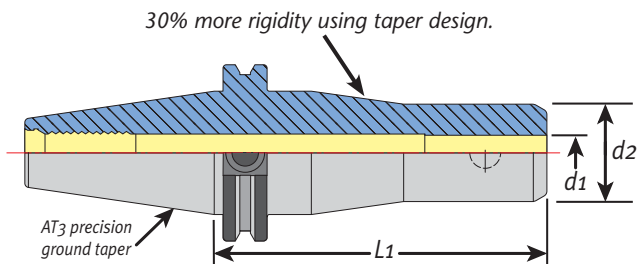
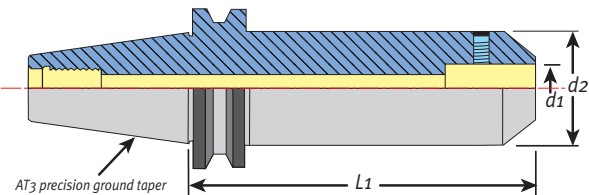

CAT40 Extended Length End Mill Holders

Part No.	Description	d1	L1	d2
22907-6	CAT40 x 1/8" I.D. - 6"	1/8"	6"	.69"
22909-6	CAT40 x 3/16" I.D. - 6"	3/16"	6"	.69"
22911-6	CAT40 x 1/4" I.D. - 6"	1/4"	6"	.78"
22915-5	CAT40 x 3/8" I.D. - 5"	3/8"	5"	1.0"
22917-4.63	CAT40 x 1/2" I.D. - 4.63"	1/2"	4.63"	1.25"
22920-5.75	CAT40 x 5/8" I.D. - 5.75"	5/8"	5.75"	1.5"
22921-5	CAT40 x 3/4" I.D. - 5"	3/4"	5"	1.75"
22925-6	CAT40 x 1.0" I.D. - 6"	1.0"	6"	2"
22927-6	CAT40 x 1 -1/4" I.D. - 6"	1 -1/4"	6"	2.5"

CAT40 Rigid Reach End Mill Holders

Part No.	Description	d1	L1	d2
22907-5.00-RR	CAT40 x 1/8" I.D. - 5"	1/8"	5"	.78"
22909-4.72-RR	CAT40 x 3/16" I.D. - 4.72"	3/16"	4.72"	.78"
22911-4.72-RR	CAT40 x 1/4" I.D. - 4.72"	1/4"	4.72"	.78"
22913-4.72-RR	CAT40 x 5/16" I.D. - 4.72"	5/16"	4.72"	.86"
22915-4.72-RR	CAT40 x 3/8" I.D. - 4.72"	3/8"	4.72"	1.0"
22917-4.72-RR	CAT40 x 1/2" I.D. - 4.72"	1/2"	4.72"	1.38"

CAT40 Precision CoolBLAST End Mill Holders



CoolBLAST Features

- Blast coolant directly on tool path
- No need for expensive coolant-thru tools
- High precision bore (H5) is best in industry



Techniks Certified for bore and taper tolerances



Retention Knobs
pg. 200



Lock Screws
pg. 89



Wrenches
pg. 204



Tightening Stands
pg. 206

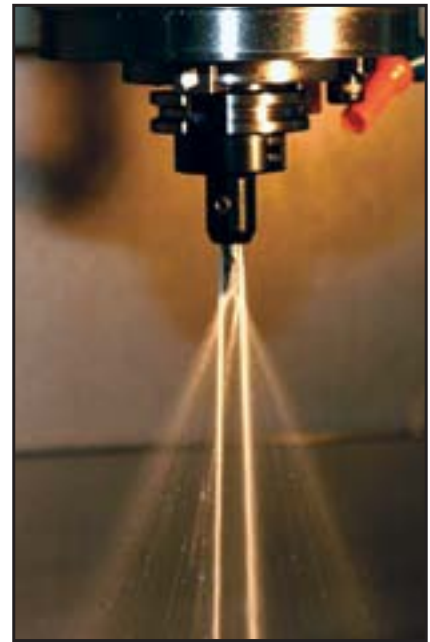

CoolBLAST in-the-bore coolant ports blast coolant on the tool path, even at high RPMs.

CAT40 CoolBLAST End Mill Holders

Part No.	Description	d1	l1	d2
22909-6B	CAT40 x 3/16" I.D. - 6"	3/16"	6"	.69"
22911-2.5B	CAT40 x 1/4" I.D. - 2.5"	1/4"	2.5"	.78"
22911-6B	CAT40 x 1/4" I.D. - 6"	1/4"	6"	.78"
22915-2.5B	CAT40 x 3/8" I.D. - 2.5"	3/8"	2.5"	1.0"
22915-4B	CAT40 x 3/8" I.D. - 4"	3/8"	4"	1.0"
22917-2.5B	CAT40 x 1/2" I.D. - 2.5"	1/2"	2.5"	1.25"
22917B	CAT40 x 1/2" I.D. - 3"	1/2"	3"	1.25"
22917-4B	CAT40 x 1/2" I.D. - 4"	1/2"	4"	1.25"
22919B	CAT40 x 5/8" I.D. - 3"	5/8"	3"	1.5"
22919-4B	CAT40 x 5/8" I.D. - 4"	5/8"	4"	1.5"
22921-1.75B	CAT40 x 3/4" I.D. - 1.75"	3/4"	1.75"	1.75"
22921-3B	CAT40 x 3/4" I.D. - 3"	3/4"	3"	1.75"
22921-4B	CAT40 x 3/4" I.D. - 4"	3/4"	4"	1.75"
22925B	CAT40 x 1.0" I.D. - 4"	1.0"	4"	2"

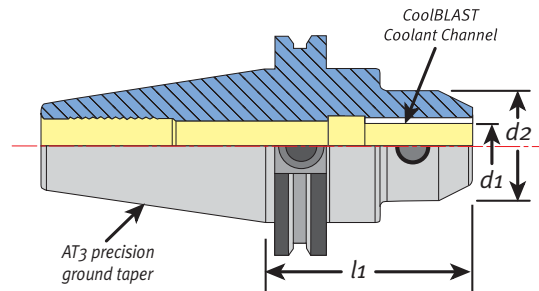

CAT40 Precision CoolFLEX End Mill Holders



Techniks Certified for bore and taper tolerances

CoolFLEX Features

- Coolant-thru spindle or thru flange (DIN B)
- No need for expensive coolant-thru tools
- H5 bore tolerance to increase tool life

Techniks H5 Bore Tolerance Extends Tool Life 60%

You lose 10% of cutting tool life for every .0001" of T.I.R.

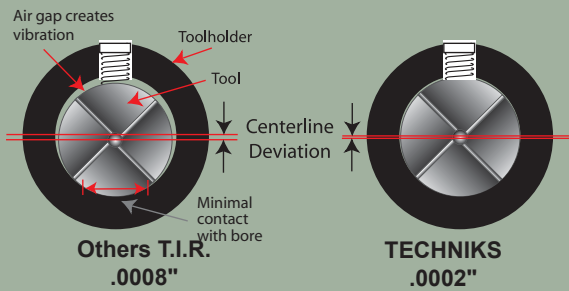

CoolFLEX holders are factory set for coolant-thru spindle.
Remove 2 setscrews for DIN B coolant-thru flange

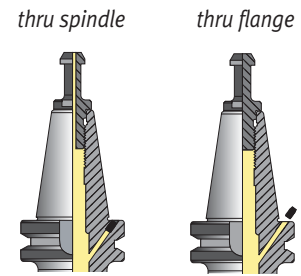

CAT40 CoolFLEX End Mill Holders

Part No.	Description	d1	l1	d2
22911F	CAT40 x 1/4" I.D. - 3"	1/4"	3"	.78"
22911-2.5F	CAT40 x 1/4" I.D. - 2.5"	1/4"	2.5"	.78"
22913-2.5F	CAT40 x 5/16" I.D. - 2.5"	5/16"	2.5"	.88"
22913F	CAT40 x 5/16" I.D. - 3"	5/16"	3"	.88"
22915-2.5F	CAT40 x 3/8" I.D. - 2.5"	3/8"	2.5"	1.0"
22915F	CAT40 x 3/8" I.D. - 3"	3/8"	3"	1.0"
22915-5F	CAT40 x 3/8" I.D. - 5"	3/8"	5"	1.0"
22916-7/16-2.5F	CAT40 x 7/16" I.D. - 2.5"	7/16"	2.5"	1.13"
22917F	CAT40 x 1/2" I.D. - 3"	1/2"	3"	1.25"
22919-1.75F	CAT40 x 5/8" I.D. - 1.75"	5/8"	1.75"	1.5"
22919F	CAT40 x 5/8" I.D. - 3"	5/8"	3"	1.5"
22921-1.75F	CAT40 x 3/4" I.D. - 1.75"	3/4"	1.75"	1.75"
22921-3F	CAT40 x 3/4" I.D. - 3"	3/4"	3"	1.75"
22921-5F	CAT40 x 3/4" I.D. - 5"	3/4"	5"	1.75"
22925-1.75F	CAT40 x 1.0" I.D. - 1.75"	1.0"	1.75"	2"
22925F	CAT40 x 1.0" I.D. - 4"	1.0"	4"	2"
22927F	CAT40 x 1-1/4" I.D. - 4.6"	1-1/4"	4.6"	2.5"
22929F	CAT40 x 1-1/2" I.D. - 4.5"	1-1/2"	4.5"	2.5"

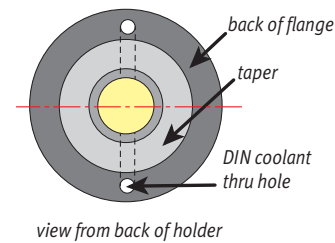

CoolFLEX DIN B Coolant

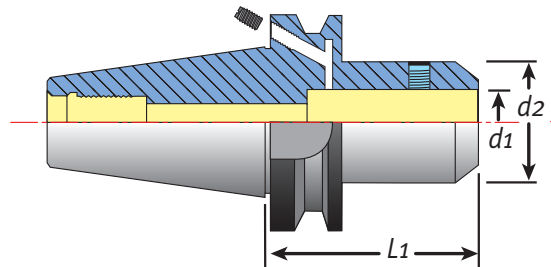

Replacement CoolFLEX Screws

Part No.	Description
HSA-4-6	40 taper DIN B screw



All Techniks products are backed by our 100% satisfaction guarantee!

CAT40 Precision CoolBLAST/CoolFLEX End Mill Holders

Precision End Mill Holders

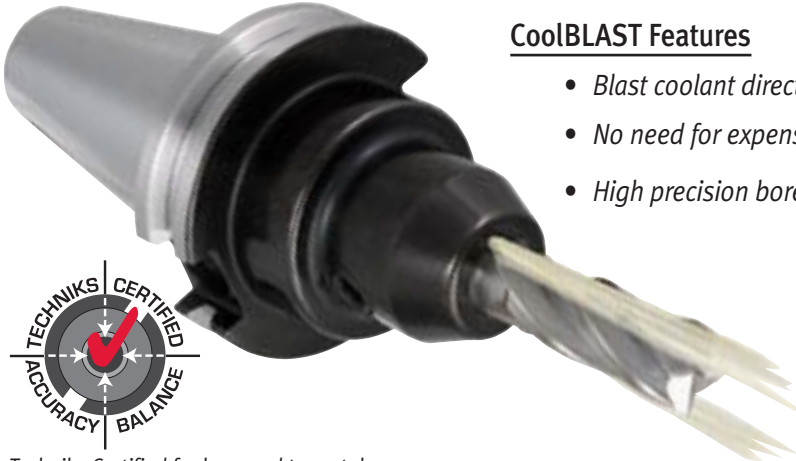

CoolBLAST Features

- Blast coolant directly on tool path
- No need for expensive coolant-thru tools
- High precision bore (H5) is best in industry



Techniks Certified for bore and taper tolerances

CoolFLEX Features

- Coolant-thru spindle or thru flange (DIN B)

CoolFLEX holders are factory set for coolant-thru spindle.

Remove 2 setscrews for DIN B coolant-thru flange

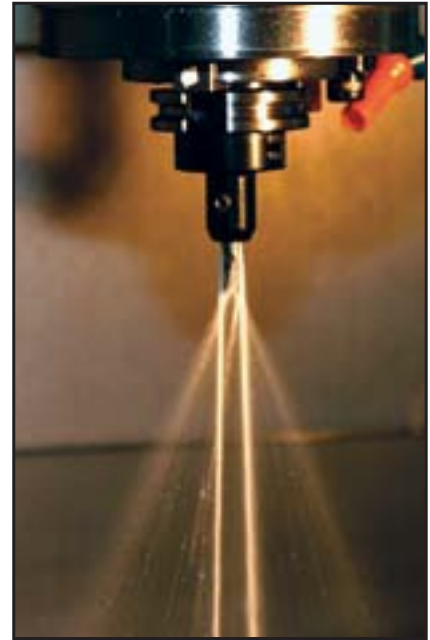
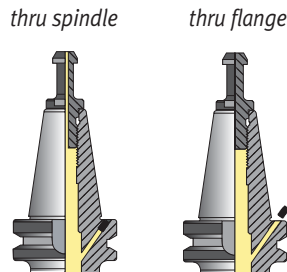

CoolBLAST in-the-bore coolant ports blast coolant on the tool path, even at high RPMs.

CAT40 CoolBLAST Holders with CoolFLEX

Part No.	Description	d1	l1	d2
22909-6FB	CAT40 x 3/16" I.D. - 6"	3/16"	6"	.69"
22911-2.5FB	CAT40 x 1/4" I.D. - 2.5"	1/4"	2.5"	.78"
22911-4FB	CAT40 x 1/4" I.D. - 4"	1/4"	4"	.78"
22911-6FB	CAT40 x 1/4" I.D. - 6"	1/4"	6"	.78"
22913-6FB	CAT40 x 5/16" I.D. - 6"	5/16"	6"	.88"
22915-2.5FB	CAT40 x 3/8" I.D. - 2.5"	3/8"	2.5"	1.0"
22915-5FB	CAT40 x 3/8" I.D. - 5"	3/8"	5"	1.0"
22917-2.5FB	CAT40 x 1/2" I.D. - 2.5"	1/2"	2.5"	1.25"
22917-4FB	CAT40 x 1/2" I.D. - 4"	1/2"	4"	1.25"
22919-1.75FB	CAT40 x 5/8" I.D. - 1.75"	5/8"	1.75"	1.5"
22920-6FB	CAT40 x 5/8" I.D. - 6"	5/8"	6"	1.5"
22921-3FB	CAT40 x 3/4" I.D. - 3"	3/4"	3"	1.75"
22925FB	CAT40 x 1.0" I.D. - 4"	1.0"	4"	2"

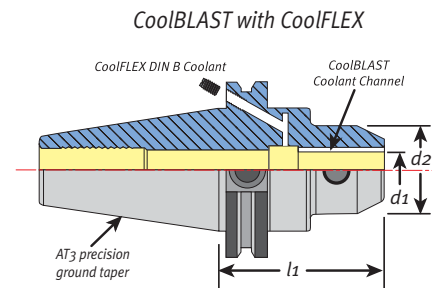

Replacement CoolFLEX Screws

Part No.	Description
HSA-4-6	40 taper DIN B screw

CAT40 DualDRIVE Precision End Mill Holders



Techniks Certified for bore and taper tolerances

Features

- Use with existing dual contact spindles
- High precision bore (H5) is best in industry
- Balanced to 10,000 RPM to save spindle bearing life



Retention Knobs
pg. 200



Lock Screws
pg. 89



Wrenches
pg. 204



Tightening Stands
pg. 206

Benefits

- Better rigidity and reduced vibration (chatter)
- Improved performance at high metal removal rates and when machining at extended lengths
- Provides the benefits of dual-contact machining on standard spindles too!

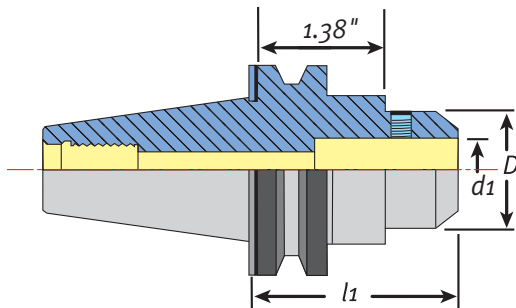

DualDRIVE For dual contact

Standard toolholder	DualDRIVE toolholder
<p>1/8" gap between toolholder and spindle face allows holder to give under high side loads.</p>	<p>DualDRIVE eliminates the gap for increased rigidity and accuracy. Works with any CAT40 spindle.</p>

US Patent 7393166B23

See an on machine demonstration video of DualDRIVE compared to standard toolholders at: www.techniksusa.com/videos2008/DD

CAT40 DualDRIVE End Mill Holders

Part No.	Description d1 – l1	l1	d1	D
72917	CAT40 x SLN 1/2" - 3" DualDRIVE toolholder	3"	1/2"	1.25"
72917-4.63	CAT40 x SLN 1/2" - 4.63" DualDRIVE toolholder	4.63"	1/2"	1.25"
72919	CAT40 x SLN 5/8" - 3" DualDRIVE toolholder	3"	5/8"	1.5"
72920	CAT40 x SLN 5/8" - 3.75" DualDRIVE toolholder	3.75"	5/8"	1.5"
72920-5.75	CAT40 x SLN 5/8" - 5.75" DualDRIVE toolholder	5.75"	5/8"	1.5"
72921	CAT40 x SLN 3/4" - 3.5" DualDRIVE toolholder	3.5"	3/4"	1.75"
72921-5	CAT40 x SLN 3/4" - 5" DualDRIVE toolholder	5"	3/4"	1.75"
72925	CAT40 x SLN 1.0" - 4" DualDRIVE toolholder	4"	1.0"	2"
72925-6	CAT40 x SLN 1.0" - 6" DualDRIVE toolholder	6"	1.0"	2"
72927	CAT40 x SLN 1-1/4" - 4.6" DualDRIVE toolholder	4.6"	1-1/4"	2.5"
72927-4	CAT40 x SLN 1-1/4" - 4" DualDRIVE toolholder	4"	1-1/4"	2.5"
72927-6	CAT40 x SLN 1-1/4" - 6" DualDRIVE toolholder	6"	1-1/4"	2.5"
72929	CAT40 x SLN 1-1/2" - 4 1/2" DualDRIVE toolholder	4.5"	1-1/2"	2.5"



Sign up to receive special offers at: www.techniksusa.com

CAT50 Precision End Mill Holders



Techniks Certified for bore and taper tolerances



Stubby

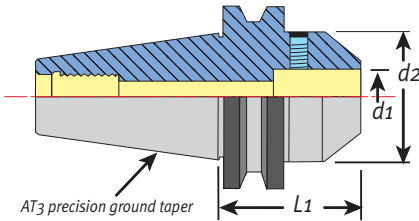

Features

- High precision bore (H5) is best in industry
- Balanced to 10,000 RPM
- Taper ground to AT₃ for maximum spindle contact

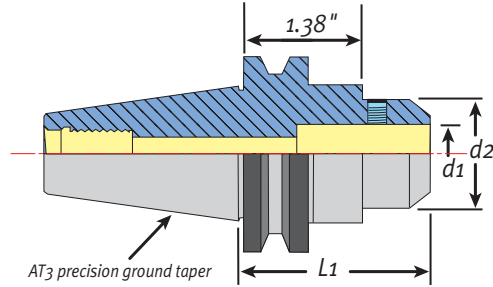

CAT50 End Mill Holders Inch Size

Part No.	Description	d1	L1	d2
22931	CAT50 x 1/4" I.D. - 4"	1/4"	4"	.78"
22933	CAT50 x 5/16" I.D. - 4"	5/16"	4"	.88"
22935	CAT50 x 3/8" I.D. - 4"	3/8"	4"	1.0"
22937	CAT50 x 1/2" I.D. - 4"	1/2"	4"	1.25"
22939-3	CAT50 x 5/8" I.D. - 3"	5/8"	3"	1.5"
22939	CAT50 x 5/8" I.D. - 4"	5/8"	4"	1.5"
22941-3	CAT50 x 3/4" I.D. - 3"	3/4"	3"	1.75"
22941	CAT50 x 3/4" I.D. - 4"	3/4"	4"	1.75"
22943	CAT50 x 7/8" I.D. - 4"	7/8"	4"	1.88"
22945	CAT50 x 1.0" I.D. - 4"	1.0"	4"	2"
22947	CAT50 x 1-1/4" I.D. - 4.6"	1-1/4"	4.6"	2.5"
22949	CAT50 x 1-1/2" I.D. - 4.6"	1-1/2"	4.6"	2.5"

CAT50 Stubby Length End Mill Holders

Part No.	Description	d1	L1	d2
22931-2 1/2	CAT50 x 1/4" I.D. - 2.5"	1/4"	2.5"	.78"
22935-2 1/2	CAT50 x 3/8" I.D. - 2.5"	3/8"	2.5"	1.0"
22937-2 5/8	CAT50 x 1/2" I.D. - 2.67"	1/2"	2.67"	1.5"
22939-9/16-1.44	CAT50 x 9/16" I.D. - 1.44"	9/16"	1.44"	1.5"
22939-9/16-3	CAT50 x 9/16" I.D. - 3"	9/16"	3"	1.5"
22939-1.44	CAT50 x 5/8" I.D. - 1.44"	5/8"	1.44"	1.5"
22941-1.44	CAT50 x 3/4" I.D. - 1.44"	3/4"	1.44"	1.75"
22945-2.62	CAT50 x 1.0" I.D. - 2.62"	1"	2.62"	2"
22947-2.62	CAT50 x 1-1/4" I.D. - 2.62"	1-1/4"	2.62"	2.5"
22949-2	CAT50 x 1-1/2" I.D. - 2"	1-1/2"	2"	2.75"

CAT50 End Mill Holders Metric Size

Part No.	Description	d1	L1	d2
22981	CAT50 x 6mm I.D. - 4"	6mm	4"	25mm
22983	CAT50 x 8mm I.D. - 4"	8mm	4"	28mm
22985	CAT50 x 10mm I.D. - 4"	10mm	4"	35mm
22987	CAT50 x 12mm I.D. - 4"	12mm	4"	42mm
22989	CAT50 x 16mm I.D. - 4"	16mm	4"	48mm
22990	CAT50 x 20mm I.D. - 3"	20mm	3"	52mm
22993	CAT50 x 25mm I.D. - 4"	25mm	4"	65mm
22996	CAT50 x 32mm I.D. - 4.6"	32mm	4.6"	72mm

CAT50 Precision End Mill Holders



Extended length



Techniks Certified for bore and taper tolerances



Retention Knobs
pg. 200



Lock Screws
pg. 89



Wrenches
pg. 204



Tightening Stands
pg. 206

Features

- High precision bore (H5) is best in industry
- Balanced to 10,000 RPM to extend spindle life
- Taper ground to AT3 for maximum spindle contact



Rigid Reach

Our Rigid Reach End Mill holders are great for machining in tight areas at extended length where tolerance is important. The tapered design improves rigidity and overall cutting performance.

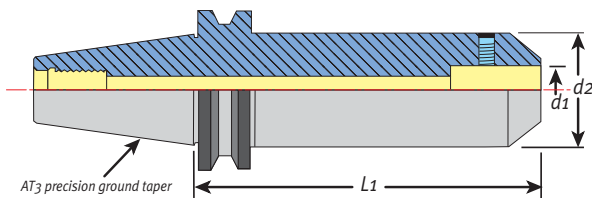

CAT50 Extended Length End Mill Holders

Part No.	Description	d1	L1	d2
22935-6	CAT50 x 3/8" I.D. - 6"	3/8"	6"	1.0"
22936-8	CAT50 x 3/8" I.D. - 8"	3/8"	8"	1.0"
22937-6	CAT50 x 1/2" I.D. - 6"	1/2"	6"	1.25"
22937-8	CAT50 x 1/2" I.D. - 8"	1/2"	8"	1.25"
22939-6	CAT50 x 5/8" I.D. - 6"	5/8"	6"	1.5"
22939-8	CAT50 x 5/8" I.D. - 8"	5/8"	8"	1.5"
22941-5.75	CAT50 x 3/4" I.D. - 5.75"	3/4"	5.75"	1.75"
22941-6	CAT50 x 3/4" I.D. - 6"	3/4"	6"	1.75"
22941-8	CAT50 x 3/4" I.D. - 8"	3/4"	8"	1.75"
22943-6	CAT50 x 7/8" I.D. - 6"	7/8"	6"	1.88"
22943-8	CAT50 x 7/8" I.D. - 8"	7/8"	8"	1.88"
22945-6	CAT50 x 1.0" I.D. - 6"	1.0"	6"	2"
22946-8	CAT50 x 1.0" I.D. - 8"	1.0"	8"	2"
22947-6	CAT50 x 1-1/4" I.D. - 6"	1-1/4"	6"	2.5"
22947-8	CAT50 x 1-1/4" I.D. - 8"	1-1/4"	8"	2.5"
22951	CAT50 x 2" I.D. - 6"	2"	6"	3.75"

Techniks H5 Bore Tolerance Extends Tool Life 60%

You lose 10% of cutting tool life for every .0001" T.I.R.

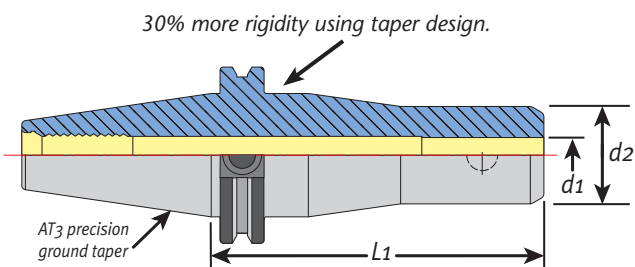
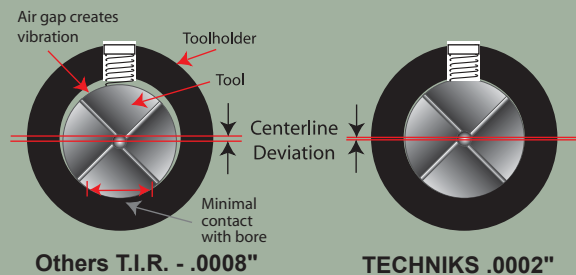

CAT50 Rigid Reach End Mill Holders

Part No.	Description	d1	L1	d2
22931-6.5-RR	CAT50 x 1/4" I.D. - 6.5"	1/4"	6.5"	.78"
22935-6.5-RR	CAT50 x 3/8" I.D. - 6.5"	3/8"	6.5"	1.0"
22937-6.5-RR	CAT50 x 1/2" I.D. - 6.5"	1/2"	6.5"	1.38"
22939-7.25-RR	CAT50 x 5/8" I.D. - 7.25"	5/8"	7.25"	1.5"
22941-7.25-RR	CAT50 x 3/4" I.D. - 7.25"	3/4"	7.25"	1.75"
22945-8-RR	CAT50 x 1.0" I.D. - 8"	1.0"	8"	2"

CAT50 Precision CoolBLAST End Mill Holders



Techniks Certified for bore and taper tolerances

CoolBLAST Features

- Blast coolant directly on tool path
- No need for expensive coolant-thru tools
- High precision bore (H5) is best in industry



Retention
Knobs
pg. 200



Lock Screws
pg. 89



Wrenches
pg. 204



Tightening
Stands
pg. 206

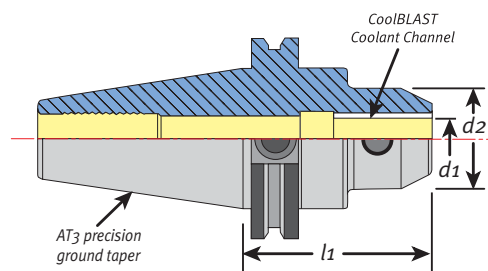

CoolBLAST in-the-bore coolant ports blast coolant on the tool path, even at high RPMs.

CAT50 CoolBLAST End Mill Holders

Part No.	Description	d1	l1	d2	Part No.	Description	d1	l1	d2
22931-2.5B	CAT50 x 1/4" I.D. - 2.5"	1/4"	2.5"	.78"	22941-3B	CAT50 x 3/4" I.D. - 3"	3/4"	3"	1.75"
22931B	CAT50 x 1/4" I.D. - 4"	1/4"	4"	.78"	22941B	CAT50 x 3/4" I.D. - 4"	3/4"	4"	1.75"
22931-6B	CAT50 x 1/4" I.D. - 6"	1/4"	6"	.78"	22941-6B	CAT50 x 3/4" I.D. - 6"	3/4"	6"	1.75"
22935-2.5B	CAT50 x 3/8" I.D. - 2.5"	3/8"	2.5"	1.0"	22941-8B	CAT50 x 3/4" I.D. - 8"	3/4"	8"	1.75"
22935B	CAT50 x 3/8" I.D. - 4"	3/8"	4"	1.0"	22943-6B	CAT50 x 7/8" I.D. - 6"	7/8"	6"	1.88"
22935-6B	CAT50 x 3/8" I.D. - 6"	3/8"	6"	1.0"	22943-8B	CAT50 x 7/8" I.D. - 8"	7/8"	8"	2"
22935-8B	CAT50 x 3/8" I.D. - 8"	3/8"	8"	1.0"	22945B	CAT50 x 1.0" I.D. - 4"	1.0"	4"	2"
22937-2.625B	CAT50 x 1/2" I.D. - 2-5/8"	1/2"	2-5/8"	1.25"	22945-6B	CAT50 x 1.0" I.D. - 6"	1.0"	6"	2"
22937B	CAT50 x 1/2" I.D. - 4"	1/2"	4"	1.25"	22946-8B	CAT50 x 1.0" I.D. - 8"	1.0"	8"	2"
22937-6B	CAT50 x 1/2" I.D. - 6"	1/2"	6"	1.25"	22947-2.62B	CAT50 x 1-1/4" I.D. - 2.62"	1-1/4"	2.62"	2.5"
22937-8B	CAT50 x 1/2" I.D. - 8"	1/2"	8"	1.25"	22947B	CAT50 x 1-1/4" I.D. - 4.6"	1-1/4"	4.6"	2.5"
22939-3B	CAT50 x 5/8" I.D. - 3"	5/8"	3"	1.5"	22947-6B	CAT50 x 1-1/4" I.D. - 6"	1-1/4"	6"	2.5"
22939B	CAT50 x 5/8" I.D. - 4"	5/8"	4"	1.5"	22947-8B	CAT50 x 1-1/4" I.D. - 8"	1-1/4"	8"	2.5"
22939-6B	CAT50 x 5/8" I.D. - 6"	5/8"	6"	1.5"	22949B	CAT50 x 1-1/2" I.D. - 4.6"	1-1/2"	4.6"	2.5"
22941-1.44B	CAT50 x 3/4" I.D. - 1.44"	3/4"	1.44"	1.75"	22951B	CAT50 x 2" I.D. - 6"	2"	6"	3.75"

CAT50 Precision CoolFLEX End Mill Holders



Techniks Certified for bore and taper tolerances

CoolFLEX Features

- Coolant-thru spindle or thru flange (DIN B)
- High precision bore (H5) is best in industry
- Balanced to 10,000 RPM

Techniks H5 Bore Tolerance Extends Tool Life 60%

You lose 10% of cutting tool life for every .0001" of T.I.R.

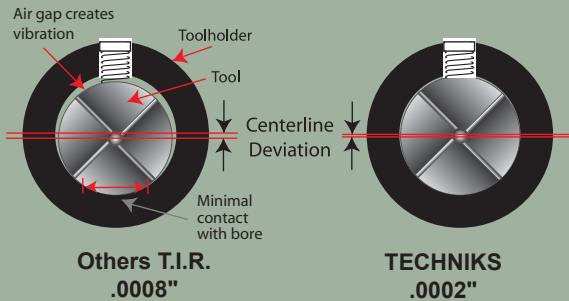

CoolFLEX holders are factory set for coolant-thru spindle.

Remove 2 setscrews for DIN B coolant-thru flange

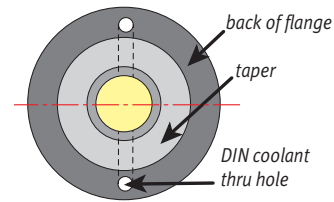
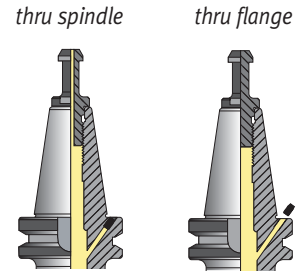

view from back of holder

CAT50 CoolFLEX End Mill Holders

Part No.	Description	d1	l1	d2
22931F	CAT50 x 1/4" I.D. - 4"	1/4"	4"	.78"
22935F	CAT50 x 3/8" I.D. - 4"	1/4"	4"	1.00"
22937F	CAT50 x 1/2" I.D. - 4"	1/2"	4"	1.25"
22937-6F	CAT50 x 1/2" I.D. - 6"	1/2"	6"	1.25"
22937-8F	CAT50 x 1/2" I.D. - 8"	1/2"	8"	1.25"
22939F	CAT50 x 5/8" I.D. - 4"	5/8"	4"	1.5"
22941-3F	CAT50 x 3/4" I.D. - 3"	3/4"	3"	1.75"
22941F	CAT50 x 3/4" I.D. - 4"	3/4"	4"	1.75"
22945-2.62F	CAT50 x 1" I.D. - 2.62"	1.0"	2.62"	2"
22945F	CAT50 x 1.0" I.D. - 4"	1.0"	4"	2"
22947F	CAT50 x 1-1/4" I.D. - 4.6"	1-1/4"	4.6"	2.5"
22949F	CAT50 x 1-1/2" I.D. - 4.6"	1-1/2"	4.6"	2.5"

CoolFLEX DIN B Coolant

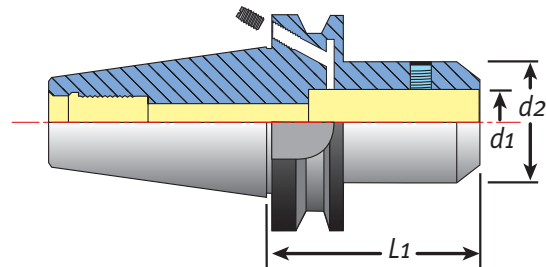

Replacement CoolFLEX Screws

Part No.	Description
HSA-6-6	50 taper DIN B screw



All Techniks products are backed by our 100% satisfaction guarantee!

CAT50 Precision DualDRIVE End Mill Holders



Techniks Certified for bore and taper tolerances

Benefits

- Better rigidity and reduced vibration (chatter)
- Improved performance at high metal removal rates and when machining at extended lengths
- Provides the benefits of dual-contact machining on standard spindles too!

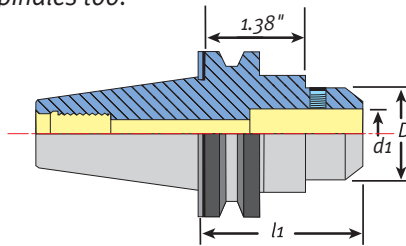

Features

- Use with existing dual contact spindles
- High precision bore (H5) is best in industry
- Balanced to 10,000 RPM to save spindle bearing life

DualDRIVE For dual contact

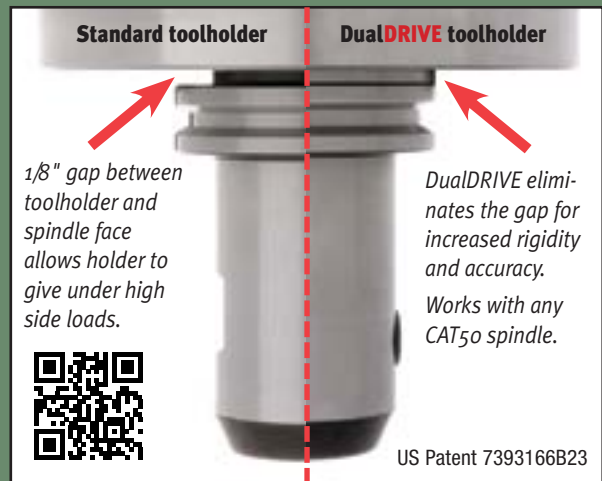

See an on machine demonstration video of DualDRIVE compared to standard toolholders at: www.techniksusa.com/videos2008/DD

CAT50 DualDRIVE End Mill Holders

Part No.	Description d1 – L1	l1	d1	D
72937	CAT50 x SLN 1/2" - 4" DualDRIVE toolholder	4"	1/2"	1.25"
72937-6	CAT50 x SLN 1/2" - 6" DualDRIVE toolholder	6"	1/2"	1.25"
72939	CAT50 x SLN 5/8" - 4" DualDRIVE toolholder	4"	5/8"	1.5"
72939-6	CAT50 x SLN 5/8" - 6" DualDrive toolholder	6"	5/8"	1.5"
72941-1.44	CAT50 x SLN 3/4" - 1.44" DualDRIVE toolholder	1.44"	3/4"	1.75"
72941-3	CAT50 x SLN 3/4" - 3" DualDRIVE toolholder	3"	3/4"	1.75"
72941	CAT50 x SLN 3/4" - 4" DualDRIVE toolholder	4"	3/4"	1.75"
72941-6	CAT50 x SLN 3/4" - 6" DualDRIVE toolholder	6"	3/4"	1.75"
72945	CAT50 x SLN 1.0" - 4" DualDRIVE toolholder	4"	1.0"	2"
72945-2.62	CAT50 x SLN 1.0" - 2.62" DualDRIVE toolholder	2.62"	1.0"	2.484"
72945-6	CAT50 x SLN 1.0" - 6" DualDRIVE toolholder	6"	1.0"	2.484"
72947-2.62	CAT50 x SLN 1-1/4" - 2.62" DualDRIVE toolholder	2.62"	1-1/4"	2.75"
72947	CAT50 x SLN 1-1/4" - 4.6" DualDRIVE toolholder	4.6"	1-1/4"	2.5"
72947-6	CAT50 x SLN 1-1/4" - 6" DualDRIVE toolholder	6"	1-1/4"	2.75"
72947-8	CAT50 x SLN 1-1/4" - 8" DualDrive toolholder	8"	1-1/4"	2.5"
72949	CAT50 x SLN 1-1/2" - 4.6" DualDRIVE toolholder	4.6"	1-1/2"	2.5"
72949-8	CAT50 x SLN 1-1/2" - 8" DualDrive toolholder	8"	1-1/2"	2.5"

BT30 DualDRIVE and Precision End Mill Holders

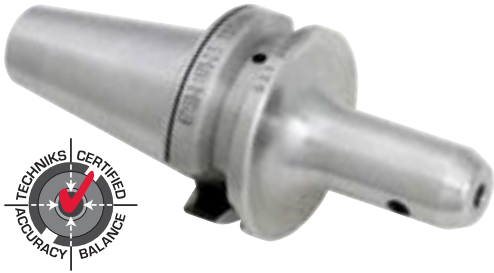

Techniks Certified for bore and taper tolerances

- Better rigidity and reduced vibration
- Improved performance at high metal removal rates or extended lengths
- Dual-contact on standard spindles too!

Features

- Use with existing dual contact spindles
- High precision bore (H5) is best in industry
- Balanced to 10,000 RPM to save spindle bearing life

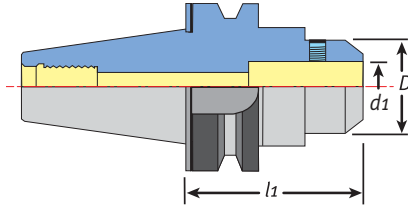

See an on-machine demonstration video of DualDRIVE compared to standard toolholders at: www.techniksusa.com/videos2008/DD

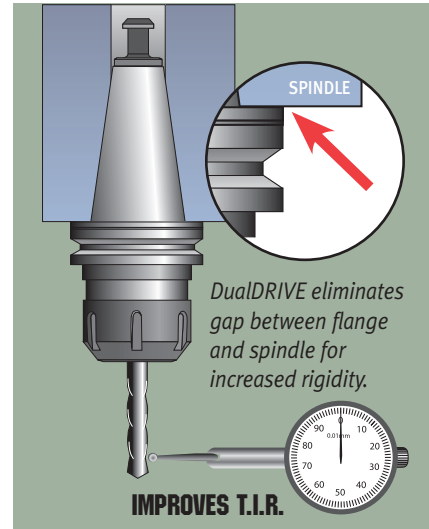

BT30 DualDRIVE End Mill Holders

Part No.	Description d1 – l1	l1	d1	D
67130-0.125-2.5	BT30 x SLN 1/8" - 2.5" DualDRIVE	2.5"	1/8"	.68"
67130-0.1875-2.5	BT30 x SLN 3/16" - 2.5" DualDRIVE	2.5"	3/16"	.68"
67130-0.25-2.5	BT30 x SLN 1/4" - 2.5" DualDRIVE	2.5"	1/4"	.78"
67130-0.375-2.5	BT30 x SLN 3/8" - 2.5" DualDRIVE	2.5"	3/8"	1.0"
67130-0.5-2.5	BT30 x SLN 1/2" - 2.5" DualDRIVE	2.5"	1/2"	1.25"
67130-0.625-2.5	BT30 x SLN 5/8" - 2.5" DualDRIVE	2.5"	5/8"	1.5"
67130-0.75-3	BT30 x SLN 3/4" - 3" DualDRIVE	3"	3/4"	1.75"



Techniks Certified for bore and taper tolerances

Features

- High precision bore (H5) is best in industry
- Balanced to 10,000 RPM
- Taper ground to AT3 for maximum spindle contact

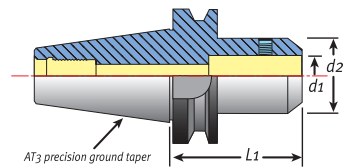

BT30 End Mill Holders

Part No.	Description	d1	L1	d2
17130-1/8	BT30 x 1/8" I.D. - 2.36" End Mill holder	1/8"	2.36"	.68"
17130-3/16	BT30 x 3/16" I.D. - 2.36" End Mill holder	3/16"	2.36"	.68"
17130-1/4	BT30 x 1/4" I.D. - 2.36" End Mill holder	1/4"	2.36"	.78"
17130-5/16	BT30 x 5/16" I.D. - 2.36" End Mill holder	5/16"	2.36"	.88"
17130-3/8	BT30 x 3/8" I.D. - 2.36" End Mill holder	3/8"	2.36"	1.0"
17130-7/16	BT30 x 7/16" I.D. - 2.36" End Mill holder	7/16"	2.36"	1.12"
17130-1/2	BT30 x 1/2" I.D. - 2.36" End Mill holder	1/2"	2.36"	1.25"
17130-5/8	BT30 x 5/8" I.D. - 2.36" End Mill holder	5/8"	2.36"	1.5"
17130-3/4	BT30 x 3/4" I.D. - 2.36" End Mill holder	3/4"	2.36"	1.75"



All Techniks products are backed by our 100% satisfaction guarantee!

BT40 Precision End Mill Holders



Techniks Certified for bore and taper tolerances

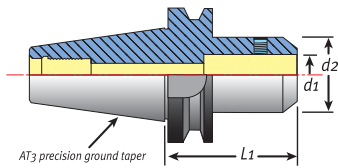

Features

- High precision bore (H5) is best in industry
- Balanced to 10,000 RPM to save spindle bearing life
- Taper ground to AT₃ for maximum spindle contact

Techniks H5 Bore Tolerance Extends Tool Life 60%

You lose 10% of cutting tool life for every .0001" of T.I.R.

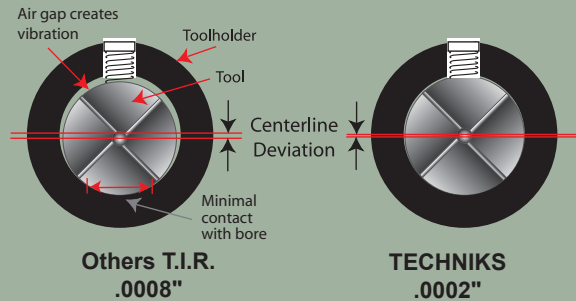

BT40 End Mill Holders Inch Size

Part No.	Description	d1	L1	d2
17140-1/8	BT40 x 1/8" I.D. - 2.5"	1/8"	2.5"	.68"
17140-3/16	BT40 x 3/16" I.D. - 2.5"	3/16"	2.5"	.68"
17140-1/4	BT40 x 1/4" I.D. - 2.5"	1/4"	2.5"	.78"
17140-5/16	BT40 x 5/16" I.D. - 2.5"	5/16"	2.5"	.88"
17140-3/8	BT40 x 3/8" I.D. - 2.5"	3/8"	2.5"	1.0"
17140-7/16	BT40 x 7/16" I.D. - 2.5"	7/16"	2.5"	1.10"
17140-1/2	BT40 x 1/2" I.D. - 2.5"	1/2"	2.5"	1.25"
17140-5/8	BT40 x 5/8" I.D. - 2.5"	5/8"	2.5"	1.50"
17140-3/4	BT40 x 3/4" I.D. - 2.5"	3/4"	2.5"	1.75"
17140-1	BT40 x 1.0" I.D. - 3.56"	1.0"	3.56"	2"
17140-1-1/4	BT40 x 1-1/4" I.D. - 3.56"	1-1/4"	3.56"	2.5"
17140-1-1/2	BT40 x 1-1/2" I.D. - 3.56"	1-1/2"	3.56"	2.5"

BT40 End Mill Holders Metric Size

Part No.	Description	d1	L1	d2
17131	BT40 x 6mm I.D. - 50mm	6mm	50mm	25mm
17132	BT40 x 8mm I.D. - 50mm	8mm	50mm	28mm
17133	BT40 x 10mm I.D. - 63mm	10mm	63mm	35mm
17134	BT40 x 12mm I.D. - 63mm	12mm	63mm	42mm
17135	BT40 x 16mm I.D. - 63mm	16mm	63mm	48mm
17135-18	BT40 x 18mm I.D. - 63mm	18mm	63mm	50mm
17136	BT40 x 20mm I.D. - 63mm	20mm	63mm	52mm
17137	BT40 x 25mm I.D. - 100mm	25mm	100mm	65mm
17138	BT40 x 32mm I.D. - 100mm	32mm	100mm	72mm

BT40 Precision End Mill Holders



Techniks Certified for bore and taper tolerances



Retention Knobs
pg. 200



Lock Screws
pg. 89



Wrenches
pg. 204



Tightening Stands
pg. 206

Techniks Certified Tooling Features

- High precision bore (H5) is best in industry
- Balanced to 10,000 RPM to extend spindle life
- Taper ground to AT3 for maximum spindle contact



Our Rigid Reach End Mill holders are great for machining in tight areas at extended length where tolerance is important. The tapered design improves rigidity and overall cutting performance.

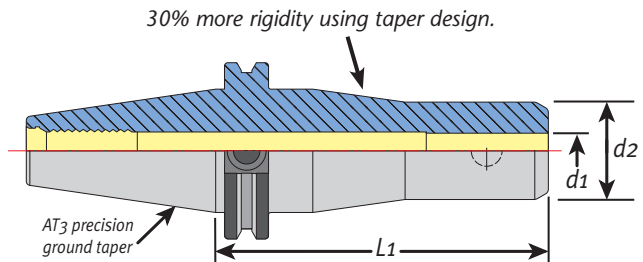
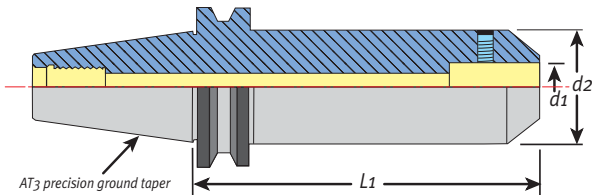

BT40 Extended Length End Mill Holders

Part No.	Description	d1	L1	d2
17140-1/8-4	BT40 x 1/8" I.D. - 4"	1/8"	4"	.68"
17140-3/16-4	BT40 x 3/16" I.D. - 4"	3/16"	4"	.68"
17140-1/4-4	BT40 x 1/4" I.D. - 4"	1/4"	4"	.78"
17140-3/8-4	BT40 x 3/8" I.D. - 4"	3/8"	4"	1.0"
17140-1/2-4	BT40 x 1/2" I.D. - 4"	1/2"	4"	1.25"
17140-5/8-4	BT40 x 5/8" I.D. - 4"	5/8"	4"	1.5"
17140-3/4-4	BT40 x 3/4" I.D. - 4"	3/4"	4"	1.75"
17140-7/8-5	BT40 x 7/8" I.D. - 5"	7/8"	5"	1.75"
17140-1-5	BT40 x 1.0" I.D. - 5"	1.0"	5"	2"

BT40 Rigid Reach End Mill Holders

Part No.	Description	d1	L1	d2
17140-1/8-5.0-RR	BT40 x 1/8" I.D. - 5"	1/8"	5"	.78"
17140-3/16-4.72-RR	BT40 x 3/16" I.D. - 4.72"	3/16"	4.72"	.78"
17140-1/4-4.72-RR	BT40 x 1/4" I.D. - 4.72"	1/4"	4.72"	.78"
17140-3/8-4.72-RR	BT40 x 3/8" I.D. - 4.72"	3/8"	4.72"	1.0"
17140-1/2-4.72-RR	BT40 x 1/2" I.D. - 4.72"	1/2"	4.72"	1.38"
17140-3/4-6-RR	BT40 x 3/4" I.D. - 6"	3/4"	6"	1.38"

BT40 Precision CoolFLEX End Mill Holders



Techniks Certified for bore and taper tolerances

CoolFLEX Features

- Coolant-thru spindle or thru flange (DIN B)
- Balanced to 10,000 RPM to save spindle bearing life
- High precision bore (H5) is best in industry



Retention Knobs
pg. 200



Lock Screws
pg. 89



Wrenches
pg. 204



Tightening Stands
pg. 206

Precision End Mill Holders

Techniks H5 Bore Tolerance Extends Tool Life 60%

You lose 10% of cutting tool life for every .0001" of T.I.R.

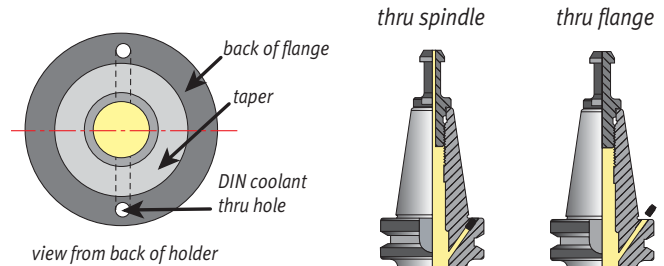
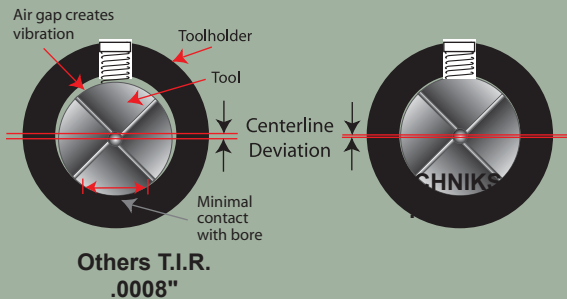

CoolFLEX holders are factory set for coolant-thru spindle.
Remove 2 setscrews for DIN B coolant-thru flange

Replacement CoolFLEX Screws

Part No.	Description
HSA-4-6	40 taper DIN B screw

BT40 CoolFLEX End Mill Holders

Part No.	Description	d1	L1	d2
17140-1/4F	BT40 x 1/4" I.D. - 2.5"	1/4"	2.5"	.78"
17140-3/8F	BT40 x 3/8" I.D. - 2.5"	3/8"	2.5"	1.0"
17140-1/2F	BT40 x 1/2" I.D. - 2.5"	1/2"	2.5"	1.25"
17140-5/8F	BT40 x 5/8" I.D. - 2.5"	5/8"	2.5"	1.50"
17140-3/4F	BT40 x 3/4" I.D. - 2.5"	3/4"	2.5"	1.75"
17140-1F	BT40 x 1.0" I.D. - 3.56"	1.0"	3.56"	2"
17140-1-1/4F	BT40 x 1-1/4" I.D. - 3.56"	1-1/4"	3.56"	2.5"

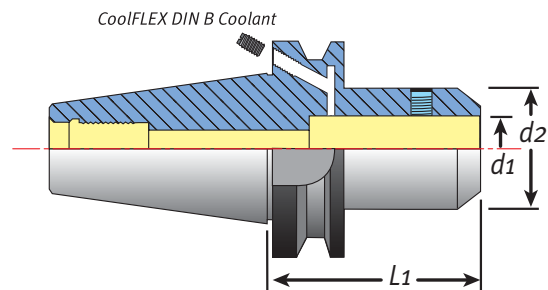

BT50 Precision End Mill Holders – End Mill Lock Screws



Techniks Certified for bore and taper tolerances

Features

- High precision bore (H5) is best in industry
- Balanced to 10,000 RPM to save spindle bearing life
- Taper ground to AT3 for maximum spindle contact

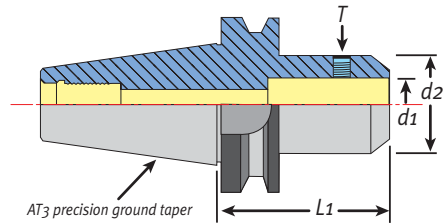

BT50 End Mill Holders

Part No.	Description	d1	l1	d2
17150-1/4	BT50 x 1/4" I.D. - 3"	1/4"	3"	.78"
17150-3/8	BT50 x 3/8" I.D. - 2.75"	3/8"	2.75"	1.0"
17150-1/2	BT50 x 1/2" I.D. - 3"	1/2"	3"	1.25"
17150-5/8	BT50 x 5/8" I.D. - 3"	5/8"	3"	1.5"
17150-3/4	BT50 x 3/4" I.D. - 3"	3/4"	3"	1.75"
17150-1-4.5	BT50 x 1.0" I.D. - 4.5"	1.0"	4.5"	2"
17150-1-6	BT50 x 1.0" I.D. - 6"	1.0"	6"	2"
17150-1-1/4-4.5	BT50 x 1.25" I.D. - 4.5"	1.25"	4.5"	2.5"
18593	BT50 x 1.5" I.D. - 4.13"	1.5"	4.13"	-

Specify your bore I.D. (shank size) when ordering replacement lock screws. All of our "Stubby" length End Mill holders take the same lock screw.



End Mill Holder Replacement Lock Screws

Part No.	Fits EMH I.D.	Length	Torque	Thread
22954-5/16	1/8"	5/16" (.3125)	.6 ft/lbs	6-32
22955-1/4	3/16"	1/4" (.25)	.8 ft/lbs	8-32
22956-5/16	1/4"	5/16" (.3125)	6.5 ft/lbs	1/4-28
22957-5/16	5/16"	5/16" (.3125)	14 ft/lbs	5/16-24
22958-5/16	3/8"	5/16" (.3125)	16 ft/lbs	3/8-24
22959-7/16	7/16"	5/16" (.3125)	16 ft/lbs	7/16-20
22959-3/8	1/2"	3/8" (.375)	24 ft/lbs	7/16-20

Part No.	Fits EMH I.D.	Length	Torque	Thread
22959-7/16	5/8"	7/16" (.4375)	36 ft/lbs	1/2-20
22961-1/2	3/4"	1/2" (.5)	36 ft/lbs	5/8-18
22961-1/2	7/8"	1/2" (.5)	76 ft/lbs	5/8-18
22962-1/2	1.0"	1/2" (.5)	150 ft/lbs	3/4-16
22962-5/8	1-1/4"	5/8" (.625)	150 ft/lbs	3/4-16
22962-1/2	1-1/2"	1/2" (.5)	150 ft/lbs	3/4-16
22962-7/8	2"	7/8" (.875)	270 ft/lbs	1-14

HSK63A, 100A Precision End Mill Holders



Features

- I.D. bore tolerance is H5 (Best in Industry)
- Balanced to 10,000 RPM to save spindle bearing life
- Taper ground to AT3 for maximum spindle contact



Techniks Certified
for bore and taper
tolerances

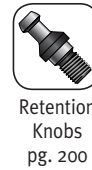
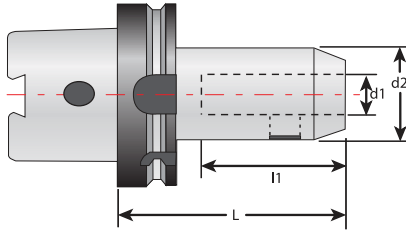

HSK63A End Mill Holders

Part No.	Description - I.D.	d1	d2	L	l1
32954	HSK63A x End Mill holder 1/2"	1/2"	1.38"	3.00"	1.97"
32956	HSK63A x End Mill holder 5/8"	5/8"	1.63"	3.75"	2.09"
32958	HSK63A x End Mill holder 3/4"	3/4"	1.75"	3.75"	2.22"
32962	HSK63A x End Mill holder 1"	1"	2.00"	3.75"	2.46"
32964	HSK63A x End Mill holder 1-1/4"	1-1/4"	2.50"	4.25"	2.51"



Techniks Certified for bore and taper tolerances

HSK100A End Mill Holders

Part No.	Description - I.D.	d1	d2	L	l1
32984	HSK100A x End Mill holder 1/2"	1/2"	1.38"	3.25"	1.97"
32986	HSK100A x End Mill holder 5/8"	5/8"	1.63"	3.75"	2.09"
32988	HSK100A x End Mill holder 3/4"	3/4"	1.75"	3.75"	2.22"
32992	HSK100A x End Mill holder 1"	1"	2.00"	4.25"	2.46"
32994	HSK100A x End Mill holder 1-1/4"	1-1/4"	2.50"	4.25"	2.51"
32996	HSK100A x End Mill holder 1-1/2"	1-1/2"	2.75"	4.50"	2.93"
32998	HSK100A x End Mill holder 2"	2"	3.75"	5.50"	3.53"

Techniks H5 Bore Tolerance Extends Tool Life 60%

You lose 10% of cutting tool life
for every .0001" of T.I.R.

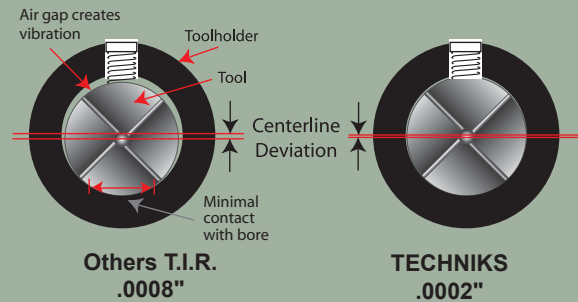

Precision ShrinkFIT Holders and Machines

Maximum rigidity and accuracy provide extended cutting tool life.

Full Line of ShrinkFIT

CAT, BT, HSK, ISO – also in extended lengths, inch and metric sizes. See our DualDRIVE ShrinkFIT holders for maximum rigidity at extended lengths.



CoolBLAST ShrinkFIT

CoolBLAST holders feature coolant ports that put coolant right on the tool.



Small Nose ShrinkFIT



SlimLINE

Regular

Use SlimLINE Holders for Machining in Tight Clearances.

You lose 10% of tool life for every .0001" of T.I.R. ShrinkFIT toolholders offer outstanding rigidity to minimize T.I.R. and extend cutting tool life.

Built for Speed.

CAT40 Precision ShrinkFIT Holders – Inch Size



Techniks Certified for accuracy and balance



Shrink Machines
pg. 110



Shrink Extensions
pg. 108



Retention Knobs
pg. 200



Wrenches
pg. 204

ShrinkFIT Holder Features

- Maximum T.I.R. only 0.0001"
- Balanced 25,000 RPM at G2.5
- Superior rigidity and holding power

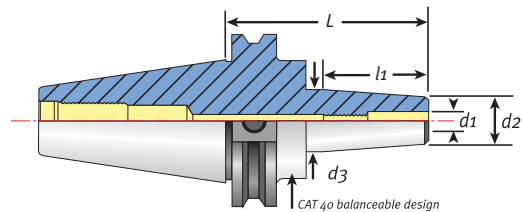

CAT40 ShrinkFIT Holders

Part No.	Description	d1	d2	d3	L	l1
29002	CAT40 x 1/8" I.D. - 3.5"	1/8"	.63"	.87"	3.5"	.79"
29006	CAT40 x 3/16" I.D. - 3.5"	3/16"	.63"	.87"	3.5"	.79"
29010	CAT40 x 1/4" I.D. - 3"	1/4"	.71"	1.06"	3"	1.42"
29011	CAT40 x 1/4" I.D. - 3.5"	1/4"	.71"	1.06"	3.5"	1.42"
29016	CAT40 x 5/16" I.D. - 3.5"	5/16"	.78"	1.06"	3.5"	1.42"
29020	CAT40 x 3/8" I.D. - 3"	3/8"	.94"	1.26"	3"	1.53"
29021	CAT40 x 3/8" I.D. - 3.75"	3/8"	.94"	1.26"	3.75"	1.53"
29025	CAT40 x 7/16" - 3"	7/16"	.94"	1.18"	3"	1.62"
29026	CAT40 x 1/2" I.D. - 3"	1/2"	1.10"	1.34"	3"	1.85"
29027	CAT40 x 1/2" I.D. - 3.75"	1/2"	1.10"	1.34"	3.75"	1.85"
29032	CAT40 x 5/8" I.D. - 3.75"	5/8"	1.26"	1.34"	3.75"	1.97"
29034	CAT40 x 3/4" I.D. - 3"	3/4"	1.42"	1.65"	3"	2.04"
29036	CAT40 x 3/4" I.D. - 4"	3/4"	1.42"	1.65"	4"	2.04"
29040	CAT40 x 1.0" I.D. - 3"	1.0"	1.81"	2.09"	3"	2.28"
29042	CAT40 x 1.0" I.D. - 4"	1.0"	1.81"	2.09"	4"	2.28"
29046	CAT40 x 1-1/4" I.D. - 4"	1-1/4"	1.81"	2.09"	4"	2.28"

CAT40 Precision Extended Length & SlimLINE



Techniks Certified for accuracy and balance

Features

- Maximum T.I.R. only .0001"
- Balanced 25,000 RPM at G2.5
- Superior rigidity and holding power

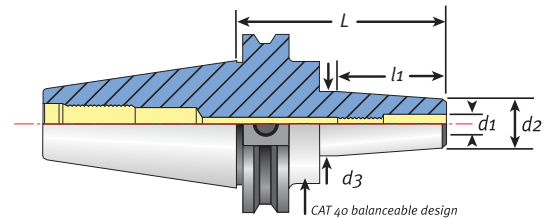

CAT40 Extended Length ShrinkFIT Holders

Part No.	Description	d1	d2	d3	L	l1
29004	CAT40 x 1/8" I.D. - 5"	1/8"	.63"	.87"	5"	.79"
29008	CAT40 x 3/16" I.D. - 5"	3/16"	.63"	.87"	5"	.79"
29013	CAT40 x 1/4" I.D. - 5"	1/4"	.71"	1.06"	5"	1.42"
29014	CAT40 x 1/4" I.D. - 6"	1/4"	.71"	1.06"	6"	1.42"
29018	CAT40 x 5/16" I.D. - 5"	5/16"	.78"	1.06"	5"	1.42"
29023	CAT40 x 3/8" I.D. - 5"	3/8"	.94"	1.26"	5"	1.53"
29024	CAT40 x 3/8" I.D. - 6"	3/8"	.94"	1.26"	6"	1.53"
29029	CAT40 x 1/2" I.D. - 5"	1/2"	1.10"	1.34"	5"	1.85"
29030	CAT40 x 1/2" I.D. - 6"	1/2"	1.10"	1.34"	6"	1.85"
29037	CAT40 x 3/4" I.D. - 5"	3/4"	1.42"	1.65"	5"	2.04"
29038	CAT40 x 3/4" I.D. - 6"	3/4"	1.42"	1.65"	6"	2.04"
29044	CAT40 x 1.0" I.D. - 6"	1.0"	1.81"	2.09"	6"	2.28"



Features

- Smaller nose diameter (d2)
- Maximum T.I.R. only 0.0001"
- Balanced 25,000 RPM at G2.5

Use SlimLINE holders for finish passes where small nose diameter (d2) tooling is required.

CAT40 SlimLINE ShrinkFIT Holders Inch Sizes

Part No.	Description	d1	d2	d3	L	l1
31528	CAT40 x 1/8" I.D. - 80mm SlimLINE	1/8"	.35"	.63"	80mm	20mm
31538	CAT40 x 3/16" I.D. - 80mm SlimLINE	3/16"	.43"	.69"	80mm	20mm
31548	CAT40 x 1/4" I.D. - 80mm SlimLINE	1/4"	.47"	.81"	80mm	36mm
31568	CAT40 x 3/8" I.D. - 80mm SlimLINE	3/8"	.63"	.94"	80mm	47mm
31588	CAT40 x 1/2" I.D. - 80mm SlimLINE	1/2"	.71"	1.06"	80mm	47mm

CAT40 SlimLINE ShrinkFIT Holders Metric Sizes

Part No.	Description	d1	d2	d3	l1	l2
29103	CAT40 x 3mm I.D. - 80mm SlimLINE	3mm	9mm	15.5mm	80mm	45mm
29104	CAT40 x 4mm I.D. - 80mm SlimLINE	4mm	10mm	16.3mm	80mm	45mm
29106	CAT40 x 6mm I.D. - 80mm SlimLINE	6mm	12mm	18.3mm	80mm	45mm



Sign up to receive special offers at: www.techniksusa.com

CAT40 Precision ShrinkFIT Toolholders – Metric Size



Techniks Certified for accuracy and balance

ShrinkFIT Features

- Maximum T.I.R. only 0.0001"
- Balanced 25,000 RPM at G2.5
- Superior rigidity and holding power



Shrink Machines
pg. 110



Shrink Extensions
pg. 108



Retention Knobs
pg. 200



Wrenches
pg. 204

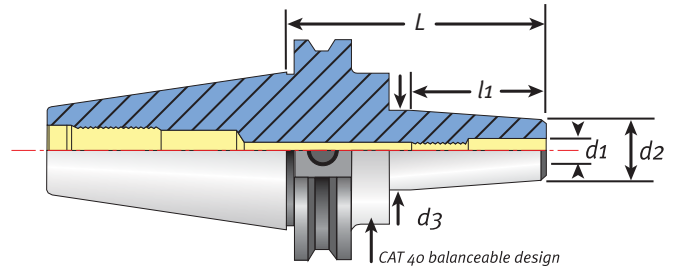

CAT40 Metric ShrinkFIT Holders

Part No.	Description	d1	d2	d3	L	l1
29204	CAT40 x 4mm I.D. - 100mm	4mm	10mm	18.7mm	100mm	55mm
29206	CAT40 x 5mm I.D. - 100mm	5mm	16mm	22mm	100mm	38mm
29208	CAT40 x 6mm I.D. - 100mm	6mm	21mm	27mm	100mm	36mm
29210	CAT40 x 6mm I.D. - 150mm	6mm	21mm	27mm	150mm	36mm
29212	CAT40 x 8mm I.D. - 100mm	8mm	21mm	27mm	100mm	36mm
29214	CAT40 x 8mm I.D. - 150mm	8mm	21mm	27mm	150mm	36mm
29216	CAT40 x 10mm I.D. - 100mm	10mm	24mm	32mm	100mm	42mm
29218	CAT40 x 10mm I.D. - 150mm	10mm	24mm	32mm	150mm	42mm
29220	CAT40 x 12mm I.D. - 100mm	12mm	24mm	32mm	100mm	47mm
29222	CAT40 x 12mm I.D. - 150mm	12mm	24mm	32mm	150mm	47mm
29224	CAT40 x 14mm I.D. - 95.3mm	14mm	27mm	34mm	95.3mm	44mm
29226	CAT40 x 14mm I.D. - 100mm	14mm	27mm	34mm	100mm	44mm
29228	CAT40 x 14mm I.D. - 152.4mm	14mm	27mm	34mm	152.4mm	44mm
29230	CAT40 x 16mm I.D. - 95.3mm	16mm	27mm	34mm	95.3mm	44mm
29232	CAT40 x 16mm I.D. - 100mm	16mm	27mm	34mm	100mm	44mm
29234	CAT40 x 16mm I.D. - 160mm	16mm	27mm	34mm	160mm	44mm
29236	CAT40 x 18mm I.D. - 100mm	18mm	33mm	42mm	100mm	50mm
29238	CAT40 x 20mm I.D. - 80mm	20mm	33mm	42mm	80mm	52mm
29240	CAT40 x 25mm I.D. - 101.6mm	25mm	44mm	53mm	101.6mm	57mm

CAT40 CoolBLAST or CoolFLEX Holders



Techniks Certified for accuracy and balance

CoolBLAST Features

- Maximum chip removal for maximum feed rates
- Balanced 25,000 RPM at G2.5
- Superior rigidity and holding power

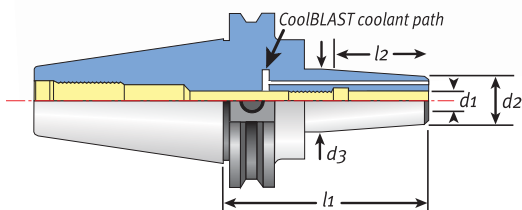

CoolBLAST coolant ports direct coolant on the tool path, even at high RPMs. No need to purchase coolant-thru cutting tools.



CAT40 CoolBLAST ShrinkFIT Holders

Part No.	Description	d1	d2	d3	l1	l2
29004B	CAT40 x 1/8" - 5" with CoolBlast	1/8"	.63"	.87"	5"	.79"
29008B	CAT40 x 3/16" - 5" with CoolBlast	3/16"	.63"	.87"	5"	.79"
29014B	CAT40 x 1/4" - 6" with CoolBlast	1/4"	.71"	1.06"	6"	1.42"
29018B	CAT40 x 5/16" - 5" with CoolBlast	5/16"	.78"	1.06"	5"	1.42"
29023B	CAT40 x 3/8" I.D. - 5" with CoolBLAST	3/8"	.94"	1.26"	5"	1.53"
29029B	CAT40 x 1/2" I.D. - 5" with CoolBLAST	1/2"	1.10"	1.34"	5"	1.85"
29033B	CAT40 x 5/8" I.D. - 5" with CoolBLAST	5/8"	1.26"	1.34"	5"	1.97"
29036B	CAT40 x 3/4" I.D. - 4" with CoolBLAST	3/4"	1.42"	1.65"	4"	2.04"
29037B	CAT40 x 3/4" I.D. - 5" with CoolBLAST	3/4"	1.42"	1.65"	5"	2.04"

CoolFLEX Features

- Coolant-thru spindle or thru flange (DIN B)

CoolFLEX holders are factory set for coolant-thru spindle. Remove 2 set-screws for DIN B coolant-thru flange.

Coolant Set Screws page 208.

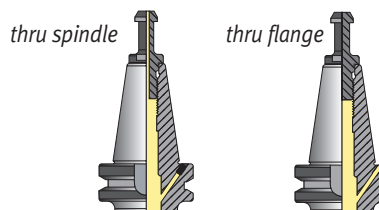
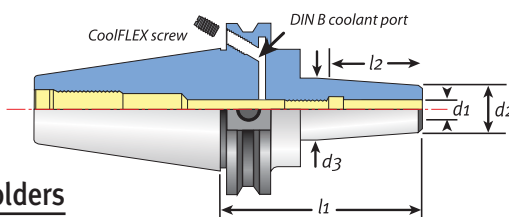

Replacement CoolFLEX Screws

Part No.	Description
HSA-4-6	40 taper DIN B screw

CAT40 CoolFLEX ShrinkFIT Holders

Part No.	Description	d1	d2	d3	l1	l2
29011F	CAT40 x 1/4" I.D. - 3.5" with CoolFLEX	1/4"	.71"	1.06"	3.5"	1.42"
29021F	CAT40 x 3/8" I.D. - 3.75" with CoolFLEX	3/8"	.94"	1.26"	3.75"	1.53"
29027F	CAT40 x 1/2" I.D. - 3.75" with CoolFLEX	1/2"	1.10"	1.34"	3.75"	1.85"
29040F	CAT40 x 1.0" I.D. - 3" with CoolFLEX	1.0"	1.81"	2.09"	3"	2.28"
29042F	CAT40 x 1.0" I.D. - 4" with CoolFLEX	1.0"	1.81"	2.09"	4"	2.28"
29046F	CAT40 x 1-1/4" I.D. - 4" with CoolFLEX	1-1/4"	1.81"	2.09"	4"	2.28"

CAT40 Precision CoolBLAST/CoolFLEX Holders



Features

- Get CoolBLAST performance from DIN B spindles
- Balanced 25,000 RPM at G2.5
- Superior rigidity and holding power



Techniks Certified for accuracy and balance



Shrink Machines
pg. 110



Shrink Extensions
pg. 108



Retention Knobs
pg. 200



Wrenches
pg. 204

CoolBLAST coolant ports direct coolant on the tool path, even at high RPMs. No need to purchase coolant-thru cutting tools.



CoolFLEX Features

- Coolant-thru spindle or thru flange (DIN B)

Coolant Set Screws page 208.

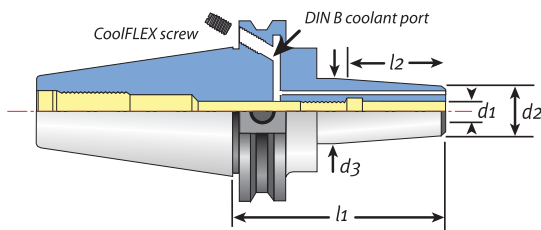

thru spindle

thru flange

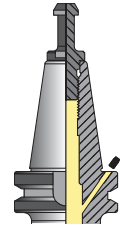
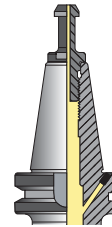

CoolFLEX holders are factory set for coolant-thru spindle. Remove 2 setscrews for DIN B coolant-thru flange.

Replacement CoolFLEX Screws

Part No.	Description
HSA-4-6	40 taper DIN B screw

CAT40 CoolBLAST and CoolFLEX DIN B Coolant Capability

Part No.	Description	d1	d2	d3	L	l1
29002FB	CAT40 x 1/8" I.D. - 3.5"	1/8"	.63"	.87"	3.5"	-
29006FB	CAT40 x 3/16" I.D. - 3.5"	3/16"	.63"	.87"	3.5"	-
29011FB	CAT40 x 1/4" I.D. - 3.5"	1/4"	.71"	1.06"	3.5"	1.42"
29016FB	CAT40 x 5/16" I.D. - 3.5"	5/16"	.78"	1.06"	3.5"	1.42"
29021FB	CAT40 x 3/8" I.D. - 3.75"	3/8"	.94"	1.26"	3.75"	1.53"
29023FB	CAT40 x 3/8" I.D. - 5"	3/8"	.94"	1.26"	5"	1.53"
29027FB	CAT40 x 1/2" I.D. - 3.75"	1/2"	1.10"	1.34"	3.75"	1.85"
29032FB	CAT40 x 5/8" I.D. - 3.75"	5/8"	1.26"	1.34"	3.75"	1.97"
29036FB	CAT40 x 3/4" I.D. - 4"	3/4"	1.42"	1.65"	4"	2.04"
29042FB	CAT40 x 1.0" I.D. - 4"	1.0"	1.81"	2.09"	4"	2.28"

CAT40 Precision DualDRIVE CoolBLAST/CoolFLEX



Benefits

- Better rigidity and reduced vibration (chatter)
- Improved performance at high metal removal rates and when machining at extended lengths
- Provides the benefits of dual-contact machining on standard spindles too!

Also available in CAT50 from stock.



CoolBLAST coolant ports direct coolant on the tool path, even at high RPMs. No need to purchase coolant-thru cutting tools.

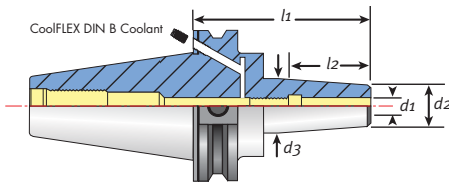

CoolFLEX Feature

CoolFLEX holders are factory set for coolant-thru spindle. Simply remove 2 stop screws for DIN B coolant-thru flange.

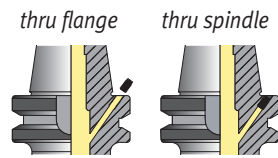

Coolant Set Screws page 208.

Features

- Use with existing dual contact spindles
- Coolant-thru spindle or thru flange (DIN B)
- Balanced to 25,000 RPM at G2.5

DualDRIVE For dual contact

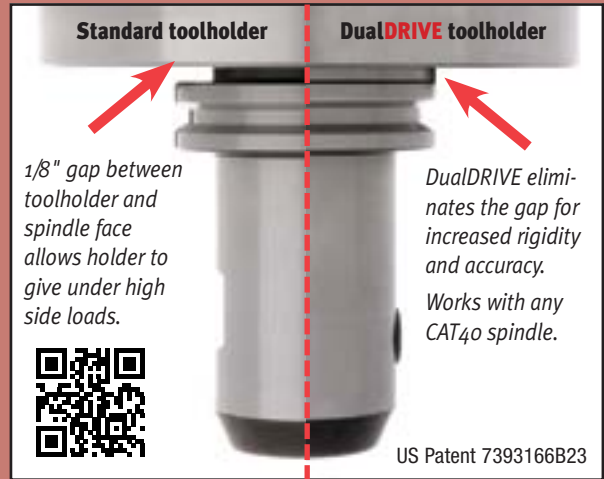

See an on machine demonstration video of DualDRIVE compared to standard toolholders at: www.technikususa.com/videos2008/DD

CAT40 DualDRIVE CoolBLAST ShrinkFIT Holders

Part No.	Description	d1	d2	d3	L	l1
79027B	CAT40 x SF 1/2" - 3.15" DualDRIVE with CoolBLAST	1/2"	28mm	34mm	3.15"	47mm
79036B	CAT40 x SF 3/4" - 3.15" DualDRIVE with CoolBLAST	3/4"	36mm	42mm	3.15"	52mm
79036B	CAT40 x SF 3/4" - 4" DualDRIVE with CoolBLAST	3/4"	36mm	42mm	4"	52mm

CAT40 DualDRIVE CoolFLEX ShrinkFIT Holders

Part No.	Description	d1	d2	d3	L	l1
79011F	CAT40 x SF 1/4" - 3.5" DualDRIVE with CoolFLEX	1/4"	18mm	27mm	3.5"	36mm
79021F	CAT40 x SF 3/8" - 3.75" DualDRIVE with CoolFLEX	3/8"	24mm	32mm	3.75"	42mm
79027F	CAT40 x SF 1/2" - 3.75" DualDRIVE with CoolFLEX	1/2"	28mm	34mm	3.75"	47mm
79036F	CAT40 x SF 3/4" - 4" DualDRIVE with CoolFLEX	3/4"	36mm	42mm	4"	52mm
79042F	CAT40 x SF 1.0" - 4" DualDRIVE with CoolFLEX	1.0"	46mm	53mm	4"	58mm
79046F	CAT40 x SF 1-1/4" DualDRIVE with CoolFLEX	1-1/4"	46mm	53mm	4"	58mm



All Techniks products are backed by our 100% satisfaction guarantee!

CAT50 Precision ShrinkFIT Toolholders – Inch Size



Features

- Maximum T.I.R. only 0.0001"
- Balanced 25,000 RPM at G2.5
- Superior rigidity and holding power



Techniks Certified for accuracy and balance



Shrink Machines
pg. 110



Shrink Extensions
pg. 108



Retention Knobs
pg. 200



Wrenches
pg. 204

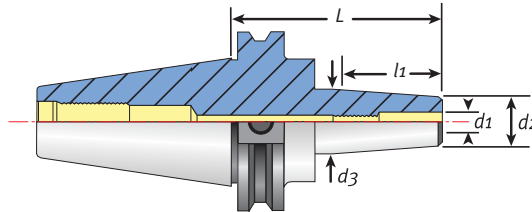

CAT50 ShrinkFIT Holders

Part No.	Description	d1	d2	d3	L	l1
29051	CAT50 x 1/8" I.D. - 4"	1/8"	.63"	.87"	4"	.79"
29052	CAT50 x 3/16" I.D. - 3.54"	3/16"	.63"	.87"	3.54"	.79"
29054	CAT50 x 1/4" I.D. - 3.54"	1/4"	.71"	1.06"	3.54"	1.42"
29056	CAT50 x 5/16" I.D. - 3.54"	5/16"	.71"	1.06"	3.54"	1.42"
29058	CAT50 x 3/8" I.D. - 3.94"	3/8"	.71"	1.06"	3.94"	1.42"
29060	CAT50 x 1/2" I.D. - 3.94"	1/2"	1.10"	1.34"	3.94"	1.85"
29062	CAT50 x 5/8" I.D. - 3.94"	5/8"	1.26"	1.34"	3.94"	1.97"
29064	CAT50 x 3/4" I.D. - 4.13"	3/4"	1.42"	1.65"	4.13"	2.04"
29068	CAT50 x 1.0" I.D. - 4.13"	1"	1.81"	2.09"	4.13"	2.28"
29072	CAT50 x 1-1/4" I.D. - 4.13"	1-1/4"	1.81"	2.09"	4.13"	2.28"
29074	CAT50 x 1-1/4" I.D. - 4.72"	1-1/4"	1.81"	1.81"	4.72"	2.28"

CAT50 Extended Length ShrinkFIT Holders

Part No.	Description	d1	d2	d3	L	l1
29052-6	CAT50 x 3/16" I.D. - 6"	3/16"	.63"	.87"	6"	.79"
29054-6	CAT50 x 1/4" I.D. - 6"	1/4"	.71"	1.06"	6"	1.42"
29054-8	CAT50 x 1/4" I.D. - 8"	1/4"	.71"	1.06"	8"	1.42"
29058-6	CAT50 x 3/8" I.D. - 6"	3/8"	.71"	1.06"	6"	1.42"
29058-8	CAT50 x 3/8" I.D. - 8"	3/8"	.71"	1.06"	8"	1.42"
29060-6	CAT50 x 1/2" I.D. - 6"	1/2"	1.10"	1.34"	6"	1.85"
29060-8	CAT50 x 1/2" I.D. - 8"	1/2"	1.10"	1.34"	8"	1.85"
29062-6	CAT50 x 5/8" I.D. - 6"	5/8"	1.26"	1.34"	6"	1.97"
29064-6	CAT50 x 3/4" I.D. - 6"	3/4"	1.42"	1.65"	6"	2.04"
29066-10	CAT50 x SF 3/4" - 10"	3/4"	1.42"	1.65"	10"	2.04"
29070	CAT50 x 1.0" I.D. - 6"	1"	1.81"	2.09"	6"	2.28"
29076	CAT50 x 1-1/4" I.D. - 6"	1-1/4"	1.81"	2.09"	6"	2.28"

CAT50 Precision ShrinkFIT Toolholders – Metric Size



Techniks Certified for accuracy and balance

Features

- Maximum T.I.R. only 0.0001"
- Balanced 25,000 RPM at G2.5
- Superior rigidity and holding power

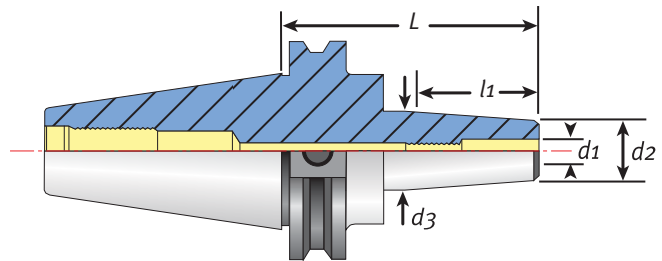

CAT50 Metric ShrinkFIT Holders

Part No.	Description	d1	d2	d3	L	l1
29252	CAT50 x 6mm - 100mm	6 mm	21 mm	27 mm	100 mm	36 mm
29256	CAT50 x 8mm - 100mm	8 mm	21 mm	27 mm	100 mm	36 mm
29260	CAT50 x 10mm - 100mm	10 mm	24 mm	32 mm	100 mm	42 mm
29264	CAT50 x 12mm - 100mm	12 mm	24 mm	32 mm	100 mm	47 mm
29268	CAT50 x 14mm - 100mm	14 mm	27 mm	34 mm	100 mm	47 mm
29272	CAT50 x 16mm - 100mm	16 mm	27 mm	34 mm	100 mm	50 mm
29276	CAT50 x 18mm - 100mm	18 mm	33 mm	42 mm	100 mm	50 mm
29278-100	CAT50 x 20mm - 100mm	20 mm	33 mm	42 mm	100 mm	52 mm
29280	CAT50 x 25mm - 100mm	25 mm	44 mm	53 mm	100 mm	58 mm
29282	CAT50 x 32mm - 100mm	32 mm	44 mm	53 mm	100 mm	58 mm

CAT50 Extended Length Metric ShrinkFIT Holders

Part No.	Description	d1	d2	d3	L	l1
29254	CAT50 x 6mm - 150mm	6 mm	21 mm	27 mm	150mm	36 mm
29254-8	CAT50 x SF 6mm - 8"	6mm	21mm	27mm	8"	36mm
29258	CAT50 x 8mm - 150mm	8 mm	21 mm	27 mm	150mm	36 mm
29258-8	CAT50 x SF 8mm - 8"	8mm	21mm	27mm	8"	36mm
29262	CAT50 x 10mm - 150mm	10 mm	24 mm	32 mm	150mm	42 mm
29266	CAT50 x 12mm - 150mm	12 mm	24 mm	32 mm	150mm	47 mm
29266-8	CAT50 x SF 12mm - 8"	12mm	24mm	32mm	8"	47mm
29270	CAT50 x 14mm - 150mm	14 mm	27 mm	34 mm	150mm	47 mm
29274	CAT50 x 16mm - 160mm	16 mm	27 mm	34 mm	150mm	50 mm

CAT50 Precision CoolBLAST ShrinkFIT Toolholders



CoolBLAST Features

- Maximum chip removal for maximum feed rates
- Balanced 25,000 RPM at G2.5
- Superior rigidity and holding power



Techniks Certified for accuracy and balance



CoolBLAST coolant ports direct coolant on the tool path, even at high RPMs. No need to purchase coolant-thru cutting tools.



Shrink Machines
pg. 110



Shrink Extensions
pg. 108



Retention Knobs
pg. 200



Wrenches
pg. 204

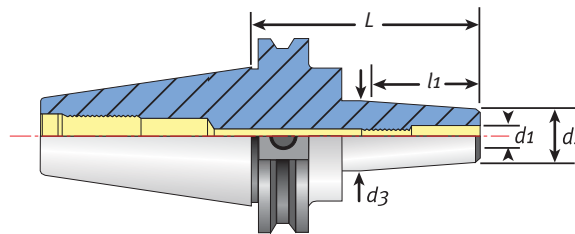

Coolant Set Screws page 208

CAT50 CoolBLAST ShrinkFIT Holders

Part No.	Description	d1	d2	d3	L	l1
29252B	CAT50 x SF 6mm - 100mm CoolBlast	6mm	.71"	1.06"	100mm	1.42"
29054B	CAT50 x SF 1/4" - 3.54" with CoolBLAST	1/4"	.71"	1.06"	3.54"	1.42"
29058B	CAT50 x SF 3/8" - 3.94" with CoolBLAST	3/8"	.78"	1.06"	3.94"	1.42"
29260B	CAT50 x SF 10mm - 100mm w/ CoolBlast	10mm	.78"	1.06"	100mm	1.42"
29060B	CAT50 x SF 1/2" - 3.94" with CoolBLAST	1/2"	1.10"	1.34"	3.94"	1.85"
29062B	CAT50 x SF 5/8" - 3.94" with CoolBLAST	5/8"	1.26"	1.34"	3.94"	1.97"
29064B	CAT50 x SF 3/4" - 4.13" with CoolBLAST	3/4"	1.42"	1.65"	4.13"	2.04"
29068B	CAT50 x SF 1" - 4.13" with CoolBLAST	1"	1.81"	2.09"	4.13"	2.28"
29072B	CAT50 x SF 1-1/4" - 4.13" w/ CoolBLAST	1-1/4"	1.81"	2.09"	4.13"	2.28"

CAT50 Extended Length CoolBLAST ShrinkFIT Holders

Part No.	Description	d1	d2	d3	L	l1
29054-6B	CAT50 x SF 1/4" - 6" with CoolBLAST	1/4"	.71"	1.06"	6"	1.42"
29058-6B	CAT50 x SF 3/8" - 6" with CoolBLAST	3/8"	.78"	1.06"	6"	1.42"
29060-6B	CAT50 x SF 1/2" - 6" with CoolBLAST	1/2"	1.10"	1.34"	6"	1.85"
29062-6B	CAT50 x SF 5/8" - 6" with CoolBLAST	5/8"	1.26"	1.34"	6"	1.97"
29066B	CAT50 x SF 3/4" - 6" with CoolBLAST	3/4"	1.42"	1.65"	6"	2.04"
29070B	CAT50 x SF 1" - 6" with CoolBLAST	1"	1.81"	2.09"	6"	2.28"

ShrinkLOC Holders For PowerLOC End Mills



**We're Making a Better Connection
Between the Cutting Tool and Spindle.**

Features

- PowerLOC indexable endmill ready
- Works with standard shank cutters too!
- Balanced to 25,000 RPMs
- Max. T.I.R. .0001"

Benefits

- Eliminates costly milling chucks
- Prevents tool slippage
- Reduces Scrap
- Extends indexable insert life up to 50%

How ShrinkLOC Holders Prevent Tool Slippage

PROBLEM



Spinning the shank under heavy load conditions causes tool slippage (red)

SOLUTION

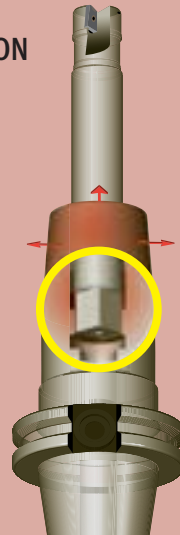

ShrinkLOC square drive (yellow) locks the tool shank and the toolholder making it impossible for the tool to spin, even under the heaviest loads.

See page 229 for more information



See page 229 for PowerLOC (PLIM) endmills

Use ShrinkLOC holders with PowerLOC endmills to get all the benefits of PowerLOC, PLUS the accuracy and rigidity of ShrinkFIT for maximum performance out of the PowerLOC (PLIM) endmill.

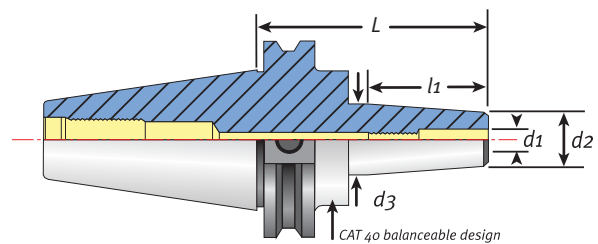

CAT 40 balanceable design

CAT40 SF Holders

Part No.	Description	Use with PLIM	d1	L	d2	l1	I.D. Square
7189027	CAT40-SL.500-3.75	1632345	0.500	3.75	1.10	2.37	.380
7189036	CAT40-SL.750-4.00	1654345	0.750	4.00	1.42	2.62	.563
7189042	CAT40-SL1.00-4.00	1665345	1.00	4.00	1.81	2.62	.750

CAT50 SF Holders

Part No.	Description	Use with PLIM	d1	L	d2	l1	I.D. Square
7189060	CAT50-SL.500-3.94	1632345	0.500	3.94	1.10	2.56	.380
7189064	CAT50-SL.750-4.13	1654345	0.750	4.13	1.42	2.76	.563
7189068	CAT50-SL.00-4.13	1665345	1.00	4.13	1.81	2.76	.750



All Techniks products are backed by our 100% satisfaction guarantee!

BT30, 40 Precision ShrinkFIT Toolholders



Techniks Certified for accuracy and balance

Features

- Maximum T.I.R. only 0.0001"
- Balanced 25,000 RPM at G2.5
- Superior rigidity and holding power



Shrink Machines
pg. 110



Shrink Extensions
pg. 108



Retention Knobs
pg. 200



Wrenches
pg. 204

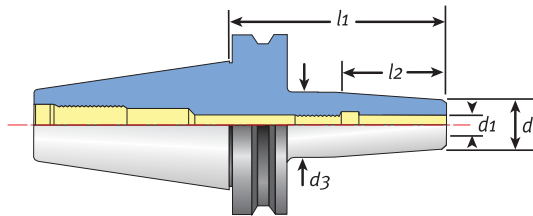

BT30 ShrinkFIT Holders

Part No.	Description	d1	d2	d3	l1	l2
67250	BT30 x 1/4" I.D. - 3"	1/4"	.71"	1.06"	3"	1.42"
67375	BT30 x 3/8" I.D. - 3"	3/8"	.78"	1.06"	3"	1.42"
67500	BT30 x 1/2" I.D. - 3"	1/2"	1.10"	1.34"	3"	1.85"
67625	BT30 x 5/8" I.D. - 3"	5/8"	1.26"	1.34"	3"	1.97"
67750	BT30 x 3/4" I.D. - 3"	3/4"	1.42"	1.15"	3"	2.04"

BT40 ShrinkFIT Holders Inch Size

Part No.	Description	d1	d2	d3	l1	l2
39110	BT40 x 3/16" I.D. - 3.54	3/16"	.63"	.87"	3.54"	.79"
39111	BT40 x 1/4" I.D. - 3.54	1/4"	.71"	1.06"	3.54"	1.42"
39113	BT40 x 3/8" I.D. - 3.54	3/8"	.78"	1.06"	3.54"	1.42"
39114	BT40 x 1/2" I.D. - 3.54	1/2"	1.10"	1.34"	3.54"	1.85"
39115	BT40 x 3/4" I.D. - 3.54	3/4"	1.42"	1.65"	3.54"	2.04"
19029	BT40 x 5/8" I.D. - 3.54	5/8"	1.06"	1.37"	3.54"	1.77"
39117	BT40 x 1.0" I.D. - 3.54	1.0"	1.81"	2.09"	3.54"	2.28"
39119-4.13	BT40 x 1-1/4" I.D. - 4.13	1-1/4"	1.81"	2.09"	4.13"	1.75"

BT40 ShrinkFIT Holders Metric Size

Part No.	Description	d1	d2	d3	l1	l2
19136-135	BT40 x 6mm I.D. - 135mm	6mm	9mm	26mm	135mm	36mm
19138	BT40 x 8mm I.D. - 90mm	8mm	21mm	26mm	90mm	36mm
19138-135	BT40 x 8mm I.D. - 135mm	8mm	11mm	26mm	135mm	36mm
19140	BT40 x 10mm I.D. - 90mm	10mm	24mm	29mm	90mm	36mm
19140-135	BT40 x 10mm - I.D. 135mm	10mm	13mm	29mm	135mm	42mm
19142	BT40 x 12mm - I.D. 90mm	12mm	24mm	29mm	90mm	47mm
19142-135	BT40 x 12mm - I.D. 135mm	12mm	15mm	29mm	135mm	47mm

HSK40E, 50E Precision ShrinkFIT Holders



Features

- Maximum T.I.R. only 0.0001"
- Balanced 25,000 RPM at G2.5
- Superior rigidity and holding power



Techniks Certified for accuracy and balance

HSK40E Inch Size ShrinkFIT Holders

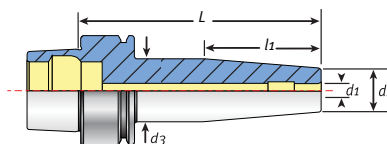

Part No.	Description	d1	d2	d3	L	l1
39001-E	HSK40E x 1/8" I.D. - 3.54"	1/8"	.63	.87"	3.54"	.79"
39002-E	HSK40E x 3/16" I.D. - 3.54"	3/16"	.63"	.87"	3.54"	.79"
39004-E	HSK40E x 1/4" I.D. - 3.54"	1/4"	.71"	1.06"	3.54"	1.42"
39006-E	HSK40E x 5/16" I.D. - 3.54"	5/16"	.79"	1.06"	3.54"	1.42"
39008-E	HSK40E x 3/8" I.D. - 3.54"	3/8"	.94"	1.26"	3.54"	1.53"

HSK40E Metric Size ShrinkFIT Holders

Part No.	Description	d1	d2	d3	L	l1
39082-E	HSK40E x 3mm I.D. - 80mm	3mm	10mm	18mm	80mm	18mm
39084-E	HSK40E x 4mm I.D. - 80mm	4mm	14mm	22mm	80mm	20mm
39088-E	HSK40E x 6mm I.D. - 80mm	6mm	21mm	27mm	80mm	36mm
39090-E	HSK40E x 8mm I.D. - 80mm	8mm	21mm	27mm	80mm	36mm
39092-E	HSK40E x 10mm I.D. - 80mm	10mm	24mm	32mm	85mm	42mm

HSK50E ShrinkFIT Holders

Part No.	Description	d1	d2	d3	L	l1
39014-E	HSK50E x 1/8" I.D. - 3.15"	1/8"	.63"	.87"	3.15"	.79"
39016-E	HSK50E x 3/16" I.D. - 3.54"	3/16"	.63"	.87"	3.54"	.79"
39018-E	HSK50E x 1/4" I.D. - 3.54"	1/4"	.71"	1.06"	3.54"	1.42"
39020-E	HSK50E x 5/16" I.D. - 3.54"	5/16"	.79"	1.06"	3.54"	1.42"
39022-E	HSK50E x 3/8" I.D. - 3.54"	3/8"	.94"	1.26"	3.54"	1.53"
39024-E	HSK50E x 1/2" I.D. - 3.54"	1/2"	1.10"	1.34"	3.54"	1.85"
39025-E	HSK50E x 5/8" I.D. - 3.54"	5/8"	1.10"	1.34"	3.54"	1.85"



Use SlimLINE holders for finish passes where small nose diameter (d2) tooling is required.

Features

- Smaller nose diameter (d2)
- Maximum T.I.R. only 0.0001"
- Balanced 25,000 RPM at G2.5

HSK40E SlimLINE ShrinkFIT Holders

Part No.	Description	d1	d2	d3	L	l1
99528	HSK40E x 1/8" I.D. - 80mm SlimLINE	1/8"	.35"	.63"	80mm	20mm
99538	HSK40E x 3/16" I.D. - 80mm SlimLINE	3/16"	.43"	.69"	80mm	20mm
99548	HSK40E x 1/4" I.D. - 80mm SlimLINE	1/4"	.47"	.81"	80mm	36mm
99568	HSK40E x 3/8" I.D. - 80mm SlimLINE	3/8"	.63"	.94"	80mm	47mm
99588	HSK40E x 1/2" I.D. - 80mm SlimLINE	1/2"	.71"	1.06"	80mm	47mm



All Techniks products are backed by our 100% satisfaction guarantee!

HSK63A Precision ShrinkFIT Holders



Techniks Certified for accuracy and balance

Features

- Maximum T.I.R. only 0.0001"
- Balanced 25,000 RPM at G2.5
- Superior rigidity and holding power

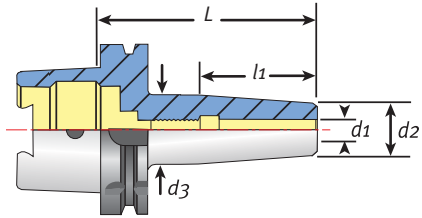

HSK63A Inch Size ShrinkFIT Toolholders

Part No.	Description	d1	d2	d3	L	l1
93115	HSK63A x 1/4" I.D. - 3.15"	1/4"	.71"	1.06"	3.15"	1.42"
93116	HSK63A x 5/16" I.D. - 3.15"	5/16"	.79"	1.06"	3.15"	1.42"
93117	HSK63A x 3/8" I.D. - 3.35"	3/8"	.94"	1.26"	3.35"	1.53"
93118	HSK63A x 7/16" I.D. - 3.54"	7/16"	1.10"	1.34"	3.54"	1.85"
93119	HSK63A x 1/2" I.D. - 3.54"	1/2"	1.10"	1.34"	3.54"	1.85"
93120	HSK63A x 9/16" I.D. - 3.54"	9/16"	1.10"	1.34"	3.54"	1.85"
93121	HSK63A x 5/8" I.D. - 3.74"	5/8"	1.26"	1.34"	3.74"	1.97"
93124	HSK63A x 3/4" I.D. - 3.94"	3/4"	1.26"	1.65"	3.94"	1.97"
93126	HSK63A x 1.0" I.D. - 4.53"	1.0"	1.42"	1.65"	4.53"	2.04"
93128	HSK63A x 1-1/4" I.D. - 4.72"	1-1/4"	1.81"	2.09"	4.72"	2.28"

HSK63A Inch Size Extended Length ShrinkFIT Toolholders

Part No.	Description	d1	d2	d3	L	l1
93130	HSK63A x 3/8" I.D. - 6.3"	3/8"	.71"	1.02"	6.3"	1.53"
93135	HSK63A x 1/2" I.D. - 6.3"	1/2"	.79"	1.10"	6.3"	1.85"
93140	HSK63A x 3/4" I.D. - 6.3"	3/4"	1.02"	1.42"	6.3"	1.97"
93145	HSK63A x 1.0" I.D. - 6.3"	1.0"	1.26"	1.65"	6.3"	2.04"



Use SlimLINE holders for finish passes where small nose diameter (d2) tooling is required.

SlimLINE Features

- Smaller nose diameter (d2)
- Maximum T.I.R. only 0.0001"
- Balanced 25,000 RPM at G2.5

HSK63A SlimLINE ShrinkFIT Holders

Part No.	Description	d1	d2	d3	L	l1
73528	HSK63A x 1/8" I.D. - 80mm SlimLINE	1/8"	.35"	.63"	80mm	20mm
73538	HSK63A x 3/16" I.D. - 80mm SlimLINE	3/16"	.43"	.69"	80mm	20mm
73548	HSK63A x 1/4" I.D. - 80mm SlimLINE	1/4"	.47"	.81"	80mm	36mm
73568	HSK63A x 3/8" I.D. - 80mm SlimLINE	3/8"	.63"	.94"	80mm	47mm
73588	HSK63A x 1/2" I.D. - 80mm SlimLINE	1/2"	.71"	1.06"	80mm	47mm

HSK63A Precision ShrinkFIT Holders



Techniks Certified for accuracy and balance

Features

- Maximum T.I.R. only 0.0001"
- Balanced 25,000 RPM at G2.5
- Superior rigidity and holding power

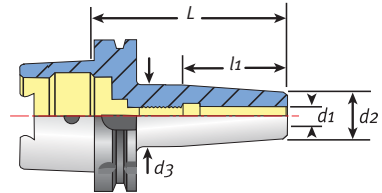

HSK63A Metric Size ShrinkFIT Toolholders

Part No.	Description	d1	d2	d3	L	l1
39132	HSK63A x 4mm I.D. - 80mm"	4mm	14mm	22mm	80mm	20mm
39134	HSK63A x 5mm I.D. - 80mm"	5mm	16mm	22mm	80mm	20mm
39136	HSK63A x 6mm I.D. - 80mm"	6mm	21mm	27mm	80mm	36mm
39138	HSK63A x 8mm I.D. - 80mm"	8mm	21mm	27mm	80mm	36mm
39140	HSK63A x 10mm I.D. - 85mm"	10mm	24mm	32mm	85mm	42mm
39142	HSK63A x 12mm I.D. - 90mm"	12mm	24mm	32mm	90mm	47mm
39144	HSK63A x 14mm I.D. - 90mm"	14mm	24mm	32mm	90mm	47mm
39146	HSK63A x 16mm I.D. - 95mm"	16mm	27mm	34mm	95mm	50mm
39148	HSK63A x 18mm I.D. - 95mm"	18mm	33mm	42mm	95mm	50mm
39150	HSK63A x 20mm I.D. - 100mm"	20mm	33mm	42mm	100mm	52mm
39152	HSK63A x 25mm I.D. - 115mm"	25mm	44mm	53mm	115mm	58mm
39154	HSK63A x 32mm I.D. - 120mm"	32mm	44mm	53mm	120mm	58mm



Coolant Set Screws page 208.

CoolBLAST Features

- Maximum chip removal for maximum feed rates
- Balanced 25,000 RPM at G2.5
- Superior rigidity and holding power

CoolBLAST coolant ports direct coolant on the tool path, even at high RPMs. No need to purchase coolant-thru cutting tools.



HSK63A Inch Size CoolBLAST ShrinkFIT Toolholders

Part No.	Description	d1	d2	d3	L	l1
93113B	HSK63A x 1/8" I.D. - 3.15" with CoolBLAST	1/8"	.63"	.87"	3.15"	.79"
93114B	HSK63A x 3/16" I.D. - 3.15" with CoolBLAST	3/16"	.63"	.87"	3.15"	.79"
93115B	HSK63A x 1/4" I.D. - 3.15" with CoolBLAST	1/4"	.71"	1.06"	3.15"	1.42"
93117B	HSK63A x 3/8" I.D. - 3.35" with CoolBLAST	3/8"	.94"	1.26"	3.35"	1.53"
93119B	HSK63A x 1/2" I.D. - 3.54" with CoolBLAST	1/2"	1.10"	1.34"	3.54"	1.85"
93121B	HSK63A x 5/8" I.D. - 3.74" with CoolBLAST	5/8"	1.26"	1.34"	3.74"	1.97"
93124B	HSK63A x 3/4" I.D. - 3.94" with CoolBLAST	3/4"	1.26"	1.65"	3.94"	1.97"



All Techniks products are backed by our 100% satisfaction guarantee!

HSK100A Precision ShrinkFIT Toolholders



Techniks Certified for accuracy and balance

Features

- Maximum T.I.R. only 0.0001"
- Balanced 25,000 RPM at G2.5
- Superior rigidity and holding power



Shrink Machines
pg. 110



Shrink Extensions
pg. 108



Retention Knobs
pg. 200



Wrenches
pg. 204

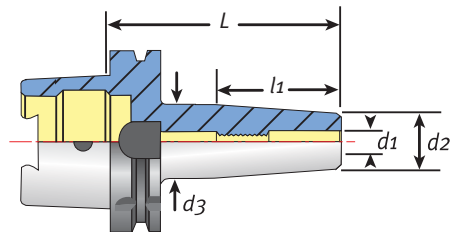

HSK100A ShrinkFIT Toolholders

Part No.	Description	d1	d2	d3	L	l1
39304	HSK100A x 1/8" I.D. - 3.54"	1/8"	.63"	.87"	3.54"	.79"
39306	HSK100A x 1/4" I.D. - 3.54"	1/4"	.71"	1.06"	3.54"	1.42"
39308	HSK100A x 5/16" I.D. - 3.35"	5/16"	.79"	1.06"	3.35"	1.42"
39310	HSK100A x 3/8" I.D. - 3.54"	3/8"	.94"	1.26"	3.54"	1.53"
39311	HSK100A x 3/8" I.D. - 6"	3/8"	.94"	1.26"	6"	1.53"
39312	HSK100A x 7/16" I.D. - 3.74"	7/16"	.94"	1.26"	3.74"	1.85"
39314	HSK100A x 1/2" I.D. - 3.74"	1/2"	1.10"	1.34"	3.74"	1.85"
39315	HSK100A x 1/2" I.D. - 6"	1/2"	1.10"	1.34"	6"	1.85"
39318	HSK100A x 5/8" I.D. - 3.94"	5/8"	1.26"	1.34"	3.94"	1.97"
39319	HSK100A x 5/8" I.D. - 6"	5/8"	1.26"	1.34"	6"	1.97"
39320	HSK100A x 3/4" I.D. - 4.13"	3/4"	1.42"	1.65"	4.13"	2.04"
39321	HSK100A x 3/4" I.D. - 6"	3/4"	1.42"	1.65"	6"	2.04"
39324	HSK100A x 1.0" I.D. - 4.53"	1.0"	1.81"	2.09"	4.53"	2.28"
39325	HSK100A x 1.0" I.D. - 6.3"	1.0"	1.81"	2.09"	6.3"	2.28"
39326	HSK100A x 1-1/4" I.D. - 4.72"	1-1/4"	1.81"	2.09"	4.72"	2.28"
39327	HSK100A x 1-1/4" I.D. - 6.3"	1-1/4"	1.81"	2.09"	6.3"	2.28"

Precision ShrinkFIT Toolholders for CNC Routers



Features

- Maximum T.I.R. only 0.0001"
- Balanced 25,000 RPM at G2.5
- Superior rigidity and holding power



Techniks Certified for accuracy and balance



Scan the QR code with a smartphone or enter this url: http://delivr.com/i0e6_qr to request our new 76 page CNC Router Tooling catalog. Or, you can call us at (800) 597-3921 to have it sent to you.

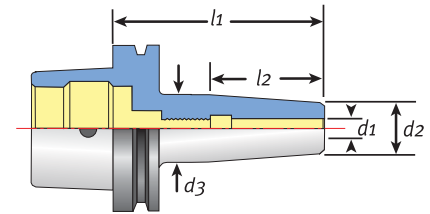
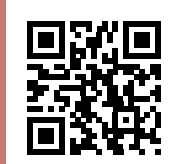

HSK63F Inch ShrinkFIT Toolholders

Part No.	Description	d1	d2	d3	l1	l2
71250	HSK63F x 1/4" I.D. - 3.15"	1/4"	.71"	1.06"	3.15"	1.42"
71312	HSK63F x 5/16" I.D. - 3.74"	5/16"	.83"	1.06"	3.74"	1.75"
71375	HSK63F x 3/8" I.D. - 3.74"	3/8"	.94"	1.26"	3.74"	1.53"
71500	HSK63F x 1/2" I.D. - 3.74"	1/2"	1.10"	1.34"	3.74"	1.85"
71625	HSK63F x 5/8" x 3.74"	5/8"	1.06"	1.34"	3.74"	1.77"
71750	HSK63F x 3/4" I.D. - 3.94"	3/4"	1.26"	1.34"	3.94"	1.97"
71100	HSK63F x 1.0" I.D. - 4.53"	1"	1.42"	1.65"	4.53"	2.04"

HSK63F Metric ShrinkFIT Toolholders

Part No.	Description	d1	d2	d3	l1	l2
71010	HSK63F x 20mm I.D. - 100mm	20mm	33mm	42mm	100mm	47mm
71011	HSK63F x 25mm I.D. - 115mm	25mm	44mm	53mm	115mm	58mm



ShrinkFIT toolholders provide concentric clamping force of 10,000 lbs or more directly on the cutting tool shank to reduce T.I.R. (runout). This is why operators are able to run faster and cutters last longer too.

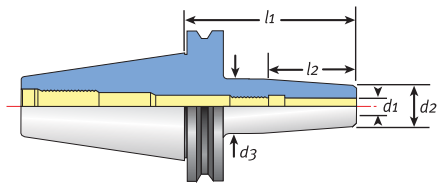

ISO30 ShrinkFIT Toolholders

Part No.	Description	d1	d2	d3	l1	l2
64250	ISO30 x 1/4" - 80	1/4"	18	27	80	39
64375	ISO30 x 3/8" - 80	3/8"	24	32	80	-
64500	ISO30 x 1/2" - 80	1/2"	28	32	80	25
64625	ISO30 x 5/8" - 80	5/8"	28	32	80	50
64750	ISO30 x 3/4" - 80	3/4"	36	41	80	-
64110	ISO30 x 1.0" - 4"	1.0"			4"	



All Techniks products are backed by our 100% satisfaction guarantee!

Universal ShrinkFIT Extensions – Coolant Set Screws



Metric sizes available upon request.

Features

- Better rigidity and T.I.R. extends tool life
- Works with a variety of toolholders
- Slim nose diameter

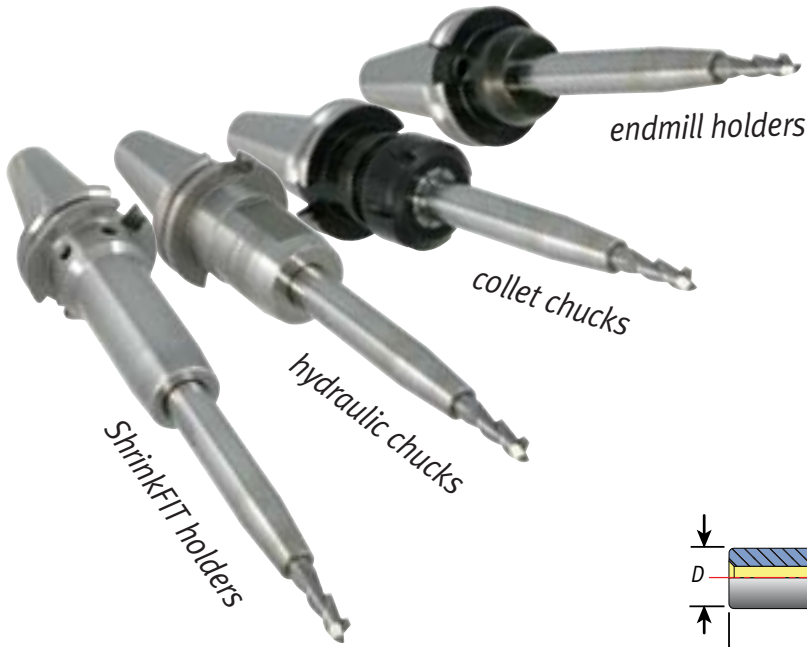

endmill holders

collet chucks

hydraulic chucks

ShrinkFIT holders



ShrinkFIT extensions and our ShrinkSTATION machine are a great way to try out ShrinkFIT.

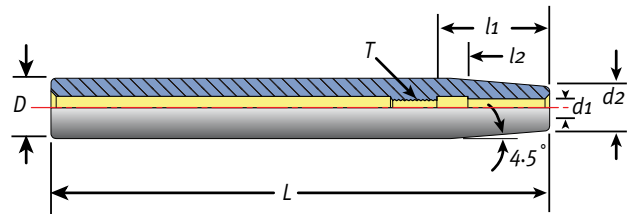

Part No.	Description	D	d1	d2	L	l1	l2	T
86062	5/8" O.D., x 1/8" I.D. - 6.3" length	5/8"	1/8"	.394"	6.3"	-	.394"	-
86064	5/8" O.D., x 3/16" I.D. - 6.3" length	5/8"	3/16"	.394"	6.3"	-	.394"	-
86066	5/8" O.D., x 1/4" I.D. - 6.3" length	5/8"	1/4"	.394"	6.3"	1.42	1.024"	M6x1.0
86076	3/4" O.D., x 1/4" I.D. - 6.3" length	3/4"	1/4"	.551"	6.3"	1.42	1.024"	M6x1.0
86080	3/4" O.D., x 3/8" I.D. - 6.3" length	3/4"	3/8"	.551"	6.3"	1.65	1.26"	M8x1.25
86090	1.0" O.D., x 3/8" I.D. - 6.3" length	1.0"	3/8"	.79"	6.3"	1.65	1.26"	M8x1.25
86092	1.0" O.D., x 1/2" I.D. - 6.3" length	1.0"	1/2"	.79"	6.3"	1.85	1.96"	M10x1.5
86094	1.0" O.D., x 5/8" I.D. - 6.3" length	1.0"	5/8"	.88"	6.3"	1.97	1.57"	M12x1.75

Coolant Set Screws

Part No.	Description	M	L	d
16080C-20	Coolant Set Screw	M5 x 0.8P	20mm	2.5
16082C-20	Coolant Set Screw	M8 x 1.25P	20mm	4
16083C-20	Coolant Set Screw	M10 x 1.5P	20mm	4
16085C-20	Coolant Set Screw	M12 x 1.75P	20mm	4
16089C-20	Coolant Set Screw	M16 x 02.0P	20mm	5
16091C-20	Coolant Set Screw	M20 x 2.0P	20mm	5

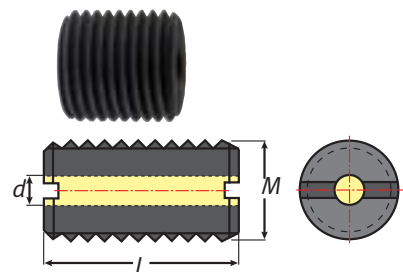

Tool Life Comparison: ER Chucks vs. ShrinkFIT

Our side-by-side testing shows you the differences.



TEST CONDITIONS

This trial was performed on a CNC Vertical Machining Center with a CT 40 taper. Identical spindle speeds, feed rates, material conditions and endmills were utilized to isolate the performance of these tool holding technologies. The test cuts were in 4140 Prehard (30-32 Rc) using 3 flute uncoated carbide center cutting endmills. The identical tool paths involved a variety of cutting directions.



ER chuck



ShrinkFIT tool

TEST RESULTS

Tool Life

The most significant comparison between these tool holding technologies is in the area of tool life. The endmill in the ShrinkFIT toolholder showed dramatically less wear (photos) compared to the endmill used in the collet chuck (note the fractured surface). Our results back up other reports that ShrinkFIT allows 4 to 7 times the tool life of other tool holding technologies. In our tests there was significant fretting on the taper of the ER collet chuck while there was virtually no fretting on the ShrinkFIT holder (visible in photo above). This was attributed to the superior wear characteristics of H-13 tool steel over ER8620.



ER chuck wear detail



ShrinkFIT wear detail

Shrink-Fit surface finish



ER collet chuck surface finish



Cutting Ability

During our four machining test passes of .125" depth of cut, the ShrinkFIT toolholder required less spindle load than the ER collet chuck toolholder. The increased rigidity of ShrinkFIT created a more balanced chip load during cutting. This was observed in a better machining sound and visual improvement in surface finish (above) and absence of fretting on the ShrinkFIT toolholder (below)



ER chuck fretting

ShrinkFIT

CONCLUSION

While both technologies have their place, machining using ShrinkFIT is a significant improvement over ER collet chuck technology. ShrinkFIT has advantages in tool life, cutting ability, surface finish, and produces less wear-and tear on the toolholder taper and spindle bearings.

ShrinkSTATION – ShrinkFIT Machine

- Microprocessor controlled induction heat changes tools in 30 seconds
- Automatic cooling using shop air eliminates handling hot tools
- For carbide shank sizes 1/8" to 1-1/4" (works best with h6 shanks)
- The benefits of ShrinkFIT without the high cost!
- Optional heat sinks reduce cooling cycle time by 50% to only 90 seconds!



small footprint
17" wide, 18" deep, 31" tall

Includes everything shown

The ShrinkSTATION is our small footprint machine. It only requires 17" x 18" of bench space, so it's easy to add to your shop.

All controls are computerized and easy to use – simply align the induction head with your toolholder, enter your shank size, and press START.

"Never Down" Guarantee

We stand behind our products 100% and expect them to out-perform the competition. Purchase any Techniks ShrinkFIT machine with confidence knowing that we can provide a backup if yours should ever need servicing!

Replacement machine is on loan until original is repaired and back in service. Replacement machines are limited to standard configuration. Power requirements may vary from original machine. Replacements are subject to availability. Extended Warranties are also available.

ShrinkSTATION Machine Includes:

Part No.	Description	QTY.
00300-02-1	small induction head (3-16mm)	1
00300-02-2	large induction head (20-32mm)	1
00165	induction stop ring (3-5mm)	1
00166	induction stop ring (6-12mm)	1
00167	induction stop ring (14-20mm)	1
00168	induction stop ring (25-32mm)	1
00151	toolholder adapter - 30 taper	1
00152	toolholder adapter - 40 taper	1
00153	toolholder adapter - 50 taper	1
00157	toolholder adapter - HSK40	1
00158	toolholder adapter - HSK50	1
00159	toolholder adapter - HSK63	1
00170	toolholder sleeve	1
200.001.018	thermal insulated glove	1

Part No.	Description	Tool Change	Rating	L x D x H	Ship Wt.
00320	ShrinkSTATION	30 seconds	1 phase, 220V, 20A	17"x 18"x 31"	42 lbs

ShrinkPRO – ShrinkFIT Machine



- Microprocessor controlled induction heat changes tools in only 6 seconds
- Air cooled after heat cycle. 90 psi shop air required
- For carbide or HSS shank sizes 1/8" to 1-1/4" (works best with h6 shanks)
- Optional heat sinks (shown) reduce cooling cycle time by 50% to only 90 seconds!
- Full color screen



Place heat sink over hot toolholder to reduce cooling time by 50%. Can be used with any ShrinkFIT machine to speed cooling process.

Heat Sinks

Part No.	Shank Range
00100-HS1	1/8" thru 1/4"
00100-HS2	1/4" thru 5/16"
00100-HS3	3/8" thru 5/8"
00100-HS4	5/8" thru 3/4"
00100-HS5	3/4" thru 1"
00100-HS6	1" thru 1 1/4"

Ask about our Quencher liquid-cool ShrinkFIT machine.

Internal quench tank cool tools in under 30 seconds!



For HSK32 Adapter order Part No. 00156.
For HSK80 Adapter order Part No. 00160.

Included With ShrinkPRO Machine

Part No.	Description	QTY.	Part No.	Description	QTY.
00165	induction stop ring (3-5mm)	1	00153	toolholder adapter - 50 taper	1
00166	induction stop ring (6-12mm)	1	00157	toolholder adapter - HSK40	1
00167	induction stop ring (14-20mm)	1	00158	toolholder adapter - HSK50	1
00168	induction stop ring (25-32mm)	1	00159	toolholder adapter - HSK63	1
00151	toolholder adapter - 30 taper	1	00170	toolholder sleeve	1
00152	toolholder adapter - 40 taper	1	200.001.018	thermal insulated glove	1

Part No.	Description	Tool Change	Rating	L x D x H	Ship Wt.
00600	ShrinkPRO machine	6-9 seconds	3 phase, 480V, 30A	20"x 20"x 37"	84 lbs



All Techniks products are backed by our 100% satisfaction guarantee!

Measurement Guide For Special Order Toolholders

**V-flange CNC machine
make, model and spindle**

**Fill in all the required dimensions (left).
Then, fax or phone in your order for a fast quote.**

V-Flange tool #1 dimensions

D = _____

F = _____

W = _____

A = _____

N = _____

V-Flange tool #2 dimensions

D = _____

F = _____

W = _____

A = _____

N = _____

**HSK CNC machine
make, model and spindle**

HSK tool #1 dimensions

D = _____

F = _____

W = _____

A = _____

N = _____

HSK tool #2 dimensions

D = _____

F = _____

W = _____

A = _____

N = _____

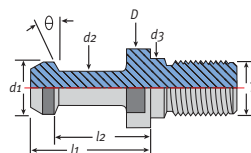
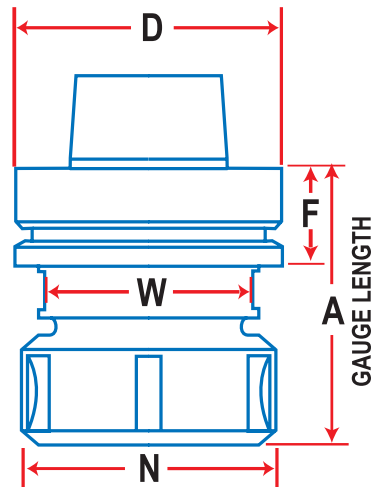
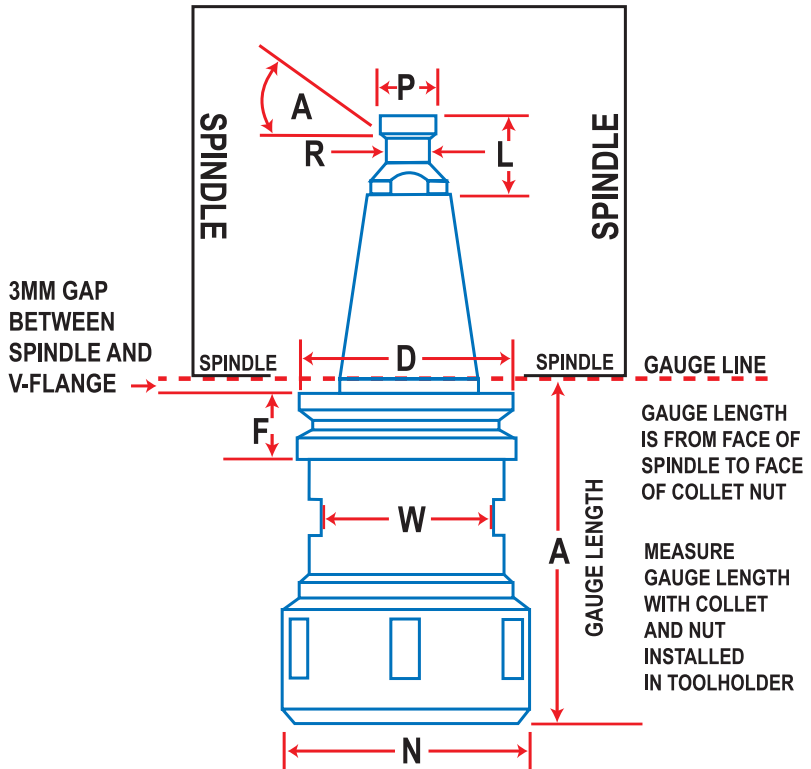

Call for special order retention knobs.

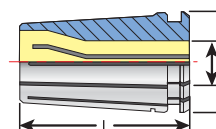

For special order collets see page 72.

Other Precision CNC Machine Toolholders

Face Mill Arbors

*H6 arbor tolerance reduces chatter
CoolBLAST coolant capable (pg. 114)*



Milling Chucks

*New coolant option available
Outstanding rigidity and performance
(pg. 122)*



Morse Taper Holders

*Techniks Certified for
accuracy (pg. 125)*



Hydraulics

*3 micron T.I.R. for
optimal accuracy (pg. 126)*



SIMIS Tooling

*ER collet chucks and
endmill holders
(pg. 128)*



Drill Chucks

*Better accuracy and
holding power (pg. 130)*



Built for Speed.

CAT40 Precision Face Mill Arbors



Features

- Compatible with all coolant-thru face mills
- H6 arbor tolerance for less chatter and better tool life
- Each arbor lab certified for accuracy
- Taper ground to AT₃ tolerance or better



Arbor
Screws
pg. 121



Tightening
Stands
pg. 206



Retention
Knobs
pg. 200



Wrenches
pg. 204

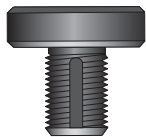

CoolBLAST arbor screw provides coolant path.
Order on page 121.

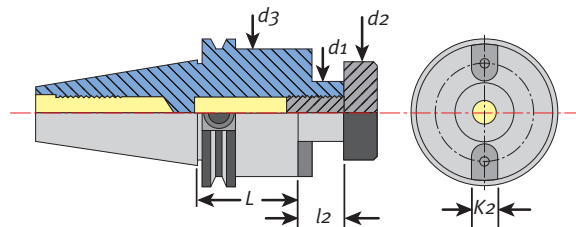

CAT40 Face Mill Arbors

Part No.	Description	L	l2	d1	d2	d3	K2
22709	CAT40 x FMA 1/2" - 1.37"	1.37"	.55"	1/2"	.66"	1.45"	.25"
22709-4	CAT40 x FMA 1/2" - 4"	4"	.55"	1/2"	.66"	1.45"	.25"
22711	CAT40 x FMA 3/4" - 1.37"	1.37"	.69"	3/4"	.88"	1.69"	.31"
22711-4	CAT40 x FMA 3/4" - 4.0"	4"	.69"	3/4"	.88"	1.69"	.31"
22711-6	CAT40 x FMA 3/4" - 6.0"	6"	.69"	3/4"	.88"	1.69"	.31"
22713	CAT40 x FMA 1.0" - 2.06"	2.06"	.69"	1.0"	1.19"	2.2"	.38"
22713-4	CAT40 x FMA 1.0" - 4.0"	4"	.69"	1.0"	1.19"	2.2"	.38"
22713-6	CAT40 x FMA 1.0" - 6.0"	6"	.69"	1.0"	1.19"	2.2"	.38"
22715	CAT40 x FMA 1-1/4" - 2.21"	2.21"	.69"	1-1/4"	1.5"	2.75"	.5"
22715-4	CAT40 x FMA 1-1/4" - 4.0"	4"	.69"	1-1/4"	1.5"	2.75"	.5"
22715-6	CAT40 x FMA 1-1/4" - 6.0"	6"	.69"	1-1/4"	1.5"	3."	.5"
22717	CAT40 x FMA 1-1/2" - 2.21"	2.21"	.94"	1-1/2"	1.88"	3.8"	.63"
22717-4	CAT40 x FMA 1-1/2" - 4"	4"	.94"	1-1/2"	1.88"	3.8"	.63"

CAT40 Precision DualDRIVE Face Mill Arbors



Features

- Compatible with all coolant-thru face mills
- H6 arbor tolerance for less chatter and better tool life
- Taper ground to AT3 tolerance or better
- Use with your existing dual contact spindles

Benefits

- Better rigidity and reduced vibration
- Improved performance at high metal removal rates and when machining at extended lengths
- Provides the benefits of dual-contact machining on standard spindles too!

See an on machine demonstration video of DualDRIVE compared to standard toolholders at: www.techniksusa.com/videos2008/DD

CoolBLAST Coolant Option

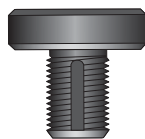

CoolBLAST arbor screw provides coolant path. Order on page 121.

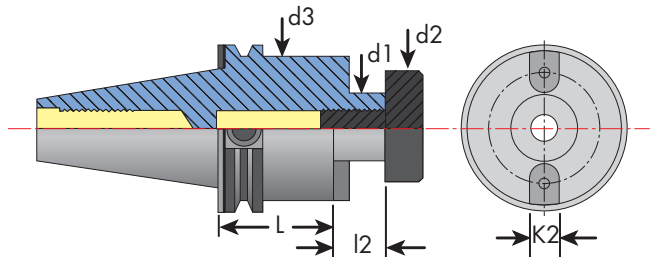
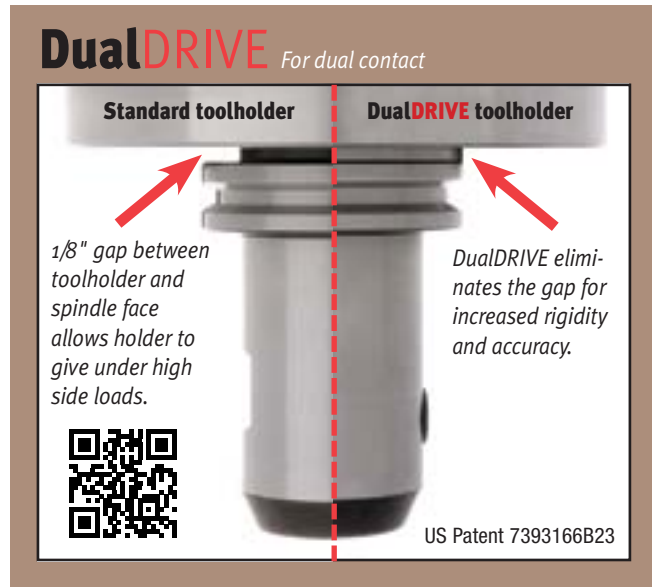

CAT40 DualDRIVE Face Mill Arbors

Part No.	Description	L	l2	d1	d2	d3	K2
72711	CAT40 x FMA 3/4" - 1.37" DualDRIVE	1.37"	.69"	3/4"	.88"	1.69"	.31"
72711-4	CAT40 x FMA 3/4" - 4" DualDRIVE	4"	.69"	3/4"	.88"	1.69"	.31"
72711-6	CAT40 x FMA 3/4" - 6" DualDRIVE	6"	.69"	3/4"	.88"	1.69"	.31"
72713	CAT40 x FMA 1.0" - 2.06" DualDRIVE	2.06"	.69"	1.0"	1.19"	2.2"	.38"
72713-4	CAT40 x FMA 1.0" - 4" DualDRIVE	4"	.69"	1.0"	1.19"	2.2"	.38"
72713-6	CAT40 x FMA 1.0" - 6" DualDRIVE	6"	.69"	1.0"	1.19"	2.2"	.38"
72715	CAT40 x FMA 1-1/4" - 2.21" DualDRIVE	2.21"	.69"	1-1/4"	1.5"	2.75"	.5"
72715-4	CAT40 x FMA 1-1/4" - 4" DualDRIVE	4"	.69"	1-1/4"	1.5"	2.75"	.5"
72715-6	CAT40 x FMA 1-1/4" - 6" DualDRIVE	6"	.69"	1-1/4"	1.5"	3"	.5"
72717	CAT40 x FMA 1-1/2" - 2.21" DualDRIVE	2.21"	.94"	1-1/2"	1.88"	3.8"	.63"
72717-4	CAT40 x FMA 1-1/2" - 4" DualDRIVE	4"	.94"	1-1/2"	1.88"	3.8"	.63"

CAT50 Precision Face Mill Arbors



Features

- Compatible with all coolant-thru face mills
- H6 arbor tolerance for less chatter and better tool life
- Each arbor lab certified for accuracy
- Taper ground to AT₃ tolerance or better



Arbor
Screws
pg. 121



Tightening
Stands
pg. 206



Retention
Knobs
pg. 200



Wrenches
pg. 204

CoolBLAST Coolant Option

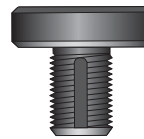
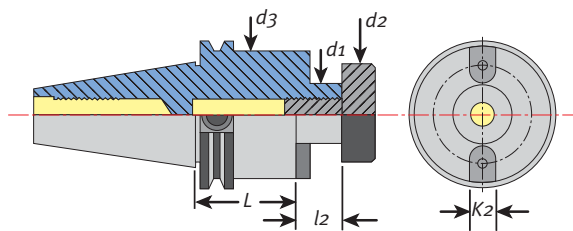

CoolBLAST arbor screw
provides coolant path.
Order on page 121.

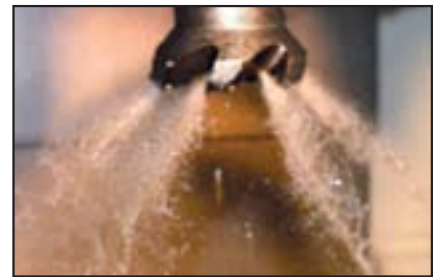

CAT50 Face Mill Arbors

Part No.	Description	L	l2	d1	d2	d3	K2
22719	CAT50 x FMA 1/2" - 1.5"	1.5"	.055"	1/2"	.66"	1.45"	.25"
22721	CAT50 x FMA 3/4" - 1.5"	1.5"	.69"	3/4"	.88"	2.75"	.31"
22721-3.5	CAT50 x FMA 3/4" - 3.5"	3.5"	.69"	3/4"	.88"	1.69"	.31"
22721-5.5	CAT50 x FMA 3/4" - 5.5"	5.5"	.69"	3/4"	.88"	1.69"	.31"
22721-8	CAT50 x FMA 3/4" - 8"	8"	.69"	3/4"	.88"	1.69"	.31"
22721-10	CAT50 x FMA 3/4" - 10"	10"	.69"	3/4"	.88"	1.69"	.31"
22723	CAT50 x FMA 1" - 2.0"	2.0"	.69"	1.0"	1.19"	2.2"	.38"
22723-4	CAT50 x FMA 1" - 4.0"	4"	.69"	1.0"	1.19"	2.2"	.38"
22723-6	CAT50 x FMA 1" - 6.0"	6"	.69"	1.0"	1.19"	2.2"	.38"
22723-8	CAT50 x FMA 1" - 8.0"	8"	.69"	1.0"	1.19"	2.2"	.38"
22723-10	CAT50 x FMA 1" - 10.0"	10"	.69"	1.0"	1.19"	2.2"	.38"
22725	CAT50 x FMA 1-1/4" - 1.50"	1.5"	.69"	1-1/4"	1.5"	2.75"	.5"
22725-3.5	CAT50 x FMA 1-1/4" - 3.5"	3.5"	.69"	1-1/4"	1.5"	2.75"	.5"
22725-6	CAT50 x FMA 1-1/4" - 6.0"	6"	.69"	1-1/4"	1.5"	2.75"	.5"
22725-8	CAT50 x FMA 1-1/4" - 8.0"	8"	.69"	1-1/4"	1.5"	2.75"	.5"
22727	CAT50 x FMA 1-1/2" - 2.4"	2.4"	.94"	1-1/2"	1.88"	3.8"	.63"
22727-4	CAT50 x FMA 1-1/2" - 4.0"	4"	.94"	1-1/2"	1.88"	3.8"	.63"
22727-6	CAT50 x FMA 1-1/2" - 6.0"	6"	.94"	1-1/2"	1.88"	3.8"	.63"
22727-8	CAT50 x FMA 1-1/2" - 8.0"	8"	.94"	1-1/2"	1.88"	3.8"	.63"
22729	CAT50 x FMA 2" - 2.4"	2.4"	.94"	2"	2.5"	4.88"	.75"
22729-4	CAT50 x FMA 2" - 4.0"	4"	.94"	2"	2.5"	4.88"	.75"

CAT50 Precision DualDRIVE Face Mill Arbors

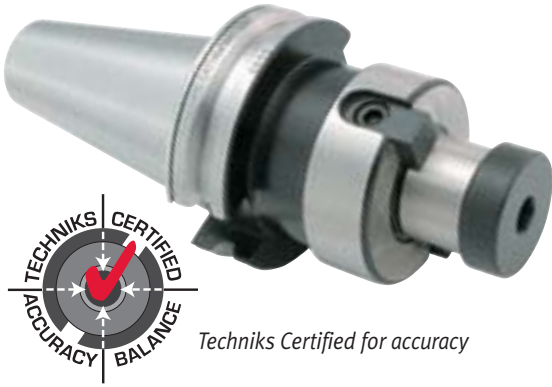

Techniks Certified for accuracy

Benefits

- Better rigidity and reduced vibration
- Improved performance at high metal removal rates and when machining at extended lengths
- Provides the benefits of dual-contact machining on standard spindles too!

See an on machine demonstration video of DualDRIVE compared to standard toolholders at: www.techniksusa.com/videos2008/DD



CoolBLAST Coolant

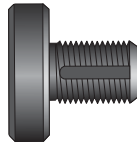

CoolBLAST arbor screw provides coolant path. Order on page 121.

Features

- Compatible with all coolant-thru face mills
- H6 arbor tolerance for less chatter and better tool life
- Use with your existing dual contact spindles

DualDRIVE For dual contact & standard spindles

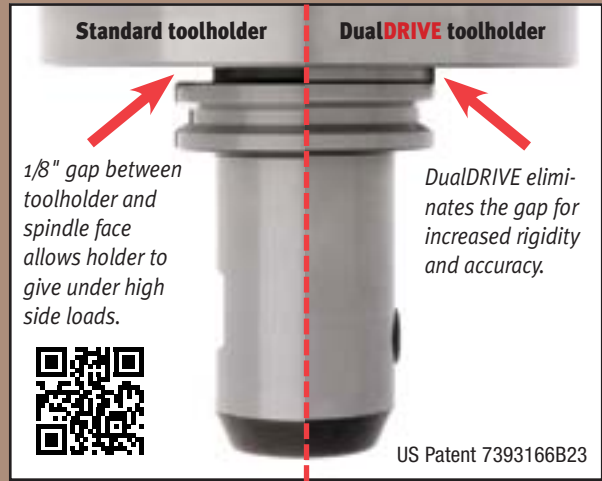

1/8" gap between toolholder and spindle face allows holder to give under high side loads.

DualDRIVE eliminates the gap for increased rigidity and accuracy.

US Patent 7393166B23

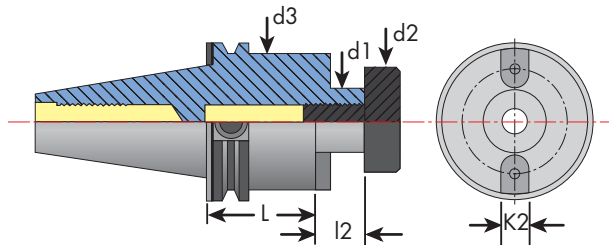

CAT50 DualDRIVE Face Mill Arbors

Part No.	Description	L	l2	d1	d2	d3	K2
72721	CAT50 x FMA 3/4" - 1.5" DualDRIVE	1.5"	.69"	3/4"	.88"	2.75"	.31"
72721-3.5	CAT50 x FMA 3/4" - 3.5" DualDRIVE	3.5"	.69"	3/4"	.88"	1.69"	.31"
72721-5.5	CAT50 x FMA 3/4" - 5.5" DualDRIVE	5.5"	.69"	3/4"	.88"	1.69"	.31"
72723	CAT50 x FMA 1.0" - 2" DualDRIVE	2"	.69"	1.0"	1.19"	2.2"	.38"
72723-4	CAT50 x FMA 1.0" - 4" DualDRIVE	4"	.69"	1.0"	1.19"	2.2"	.38"
72723-6	CAT50 x FMA 1.0" - 6" DualDRIVE	6"	.69"	1.0"	1.19"	2.2"	.38"
72725	CAT50 x FMA 1-1/4" - 1.5" DualDRIVE	1.5"	.69"	1-1/4"	1.5"	2.75"	.5"
72725-3.5	CAT50 x FMA 1-1/4" - 3.5" DualDRIVE	3.5"	.69"	1-1/4"	1.5"	2.75"	.5"
72725-6	CAT50 x FMA 1-1/4" - 6" DualDRIVE	6"	.69"	1-1/4"	1.5"	2.75"	.5"
72727	CAT50 x FMA 1-1/2" - 2.4" DualDRIVE	2.4"	.94"	1-1/2"	1.88"	3.8"	.63"
72727-4	CAT50 x FMA 1-1/2" - 4" DualDRIVE	4"	.94"	1-1/2"	1.88"	3.8"	.63"
72727-6	CAT50 x FMA 1-1/2" - 6" DualDRIVE	6"	.94"	1-1/2"	1.88"	3.8"	.63"
72727-8	CAT50 x FMA 1-1/2" - 8" DualDRIVE	8"	.94"	1-1/2"	1.88"	3.8"	.63"
72729	CAT50 x FMA 2" - 2.4" DualDRIVE	2.4"	.94"	2"	2.5"	4.88"	.75"
72729-4	CAT50 x FMA 2" - 4" DualDRIVE	4"	.94"	2"	2.5"	4.88"	.75"

BT30 DualDRIVE and BT30 Precision Face Mill Arbors



Techniks Certified for accuracy

Features

- Compatible with all coolant-thru face mills
- H6 arbor tolerance for less chatter and better tool life
- Use with your existing dual contact spindles

Benefits

- Better rigidity and reduced vibration (chatter)
- Improved performance at high metal removal rates and when machining at extended lengths
- Provides the benefits of dual-contact machining on standard spindles too!

See an on machine demonstration video of DualDRIVE compared to standard toolholders at: www.techniksusa.com/videos2008/DD

CoolBLAST Coolant Option

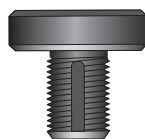

CoolBLAST arbor screw provides coolant path. Order on page 121.

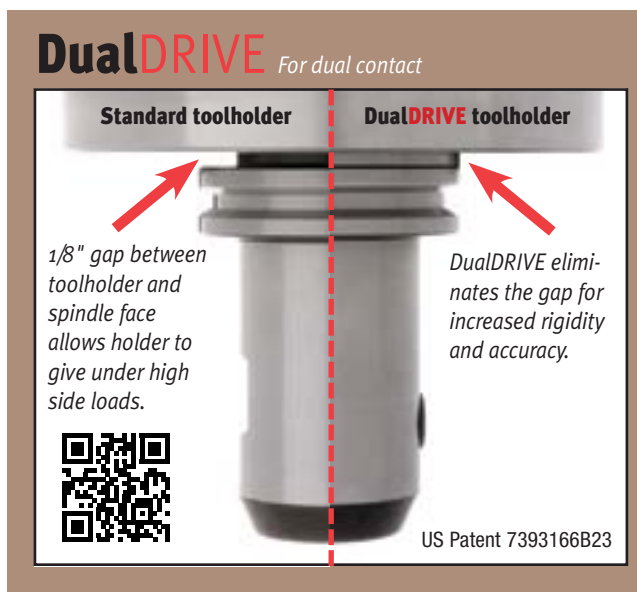

BT30 DualDRIVE Face Mill Arbors

Part No.	Description d1 – l1	L	l2	d1	d2	d3	K2
66610	BT30 x DualDRIVE FMA 3/4" - 2"	2"	.69"	3/4"	.88"	1.66"	.313"
66612-2	BT30 x DualDRIVE FMA 1.0" - 2"	2"	.69"	1.0"	1.18"	2.2"	.375"

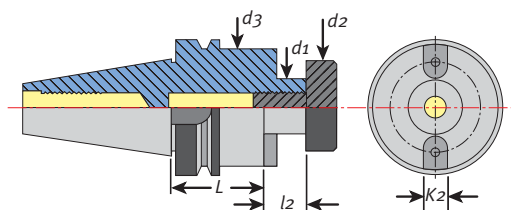

Features

- H6 arbor tolerance for less chatter and better tool life
- Each arbor lab certified for accuracy
- Taper ground to AT3 tolerance for maximum spindle contact

BT30 Precision Face Mill Arbors

Part No.	Description	L	l2	d1	d2	d3	K2
16611	BT30 x 3/4" FMA - 1.18"	1.18"	.69"	3/4"	.88"	1.66"	.313"
16612	BT30 x 1" FMA - 1.77"	1.77"	.69"	1.0"	1.18"	2.2"	.375"
16614	BT30 x 1-1/4" FMA - 1.77"	1.77"	.87"	1-1/4"	1.5"	2.37"	.5"

BT40, BT50 Precision Face Mill Arbors



Features

- Compatible with all coolant-thru face mills
- H6 arbor tolerance for less chatter and better tool life
- Each arbor lab certified for accuracy
- Taper ground to AT3 tolerance or better

CoolBLAST Coolant Option

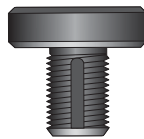

CoolBLAST arbor screw provides coolant path. Order on page 121.



Arbor Screws
pg. 121



Tightening Stands
pg. 206



Retention Knobs
pg. 200



Wrenches
pg. 204

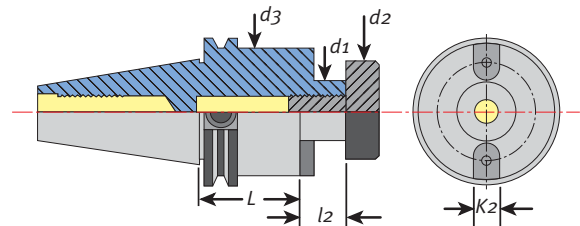

BT40, BT50 Face Mill Arbors

Part No.	Description	L	l2	d1	d2	d3	K2
16615-3/4	BT40 x 3/4" FMA - 1"	1.0"	.69"	3/4"	.88"	1.69"	.313"
16615-4	BT40 x 3/4" FMA - 4.0"	4"	.69"	3/4"	.88"	1.69"	.313"
16615-6	BT40 x 3/4" FMA - 6.0"	6"	.69"	3/4"	.88"	1.69"	.313"
16615	BT40 x 1.0" FMA - 1.77"	1.77"	.69"	1.0"	1.18"	2.2"	.375"
16617	BT40 x 1.0" FMA - 3.54"	3.54"	.69"	1.0"	1.18"	2.2"	.375"
16620	BT40 x 1-1/4" FMA - 1.77"	1.77"	.69"	1-1/4"	1.5"	2.75"	.5"
16620-4	BT40 x 1-1/4" FMA - 4"	4"	.69"	1-1/4"	1.5"	2.75"	.5"
16626	BT40 x 1-1/2" FMA - 2.36"	2.36"	.94"	1-1/2"	1.88"	3.8"	.625"
16639	BT50, 1.0" FMA - 1.77"	1.77"	.79"	1.0"	1.19"	1.97"	.375"
16639-3	BT50, 1.0" FMA - 3"	3"	.79"	3"	1.19"	1.97"	.375"
16642	BT50, 1-1/4" FMA - 1.77"	1.77"	.87"	1-1/4"	1.5"	2.34"	.5"
16645	BT50, 1-1/2" FMA - 1.77"	1.77"	.94"	1-1/2"	1.88"	3.8"	.625"
16646	BT50, 1-1/2" FMA - 75mm	75mm	.94"	1-1/2"	1.88"	3.8"	.625"
16646105	BT50, 1-1/2" FMA - 105mm	105mm	.94"	1-1/2"	1.88"	3.8"	.625"
16646150	BT50, 1-1/2" FMA - 150mm	150mm	.94"	1-1/2"	1.88"	3.8"	.625"
16648	BT50, 2.0" FMA - 2.95"	2.95"	.94"	2"	3.13"	4.88"	.75"

HSK63A, 100A Precision Face Mill Arbors



Features

- Compatible with all coolant-thru face mills
- H6 arbor tolerance for less chatter and better tool life
- Each arbor lab certified for accuracy



Arbor
Screws
pg. 121



Tightening
Stands
pg. 206



Retention
Knobs
pg. 200



Wrenches
pg. 204

CoolBLAST Coolant Option

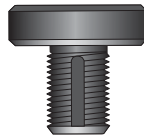

CoolBLAST arbor screw provides coolant path. Order on page 121.

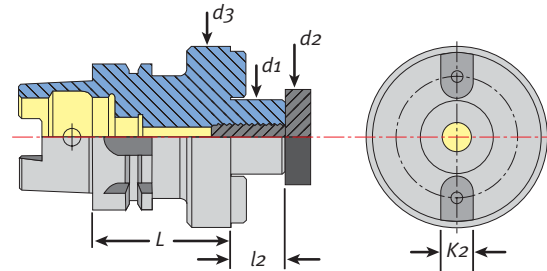

HSK63A Face Mill Arbors

Part No.	Description	L	l2	d1	d2	d3	K2
93500	HSK63A 3/4"FMA - 2"	2"	.687"	3/4"	.875"	1.69"	.313"
93501	HSK63A 1"FMA - 2.37"	2.37"	.687"	1.0"	1.24"	2.2"	.375"
93502	HSK63A 1-1/4"FMA - 2.75"	2.75"	.687"	1-1/4"	1.5"	2.75"	.5"

HSK63A Extended Length Face Mill Arbors

Part No.	Description	L	l2	d1	d2	d3	K2
93510	HSK63A 3/4"FMA - 4"	4"	.687"	3/4"	.875"	1.69"	.313"
93520	HSK63A 1.0"FMA - 4"	4"	.687"	1.0"	1.24"	2.2"	.375"
93530	HSK63A 1-1/4"FMA - 4"	4"	.687"	1-1/4"	1.5"	2.75"	.5"

HSK100A Face Mill Arbors

Part No.	Description	L	l2	d1	d2	d3	K2
95901	HSK100 A 3/4"FMA - 2"	2"	.69"	3/4"	.88"	1.69"	.31"
95903	HSK100 A 1.0"FMA - 2"	2"	.69"	1.0"	1.19"	2.2"	.38"
95905	HSK100 A 1-1/4"FMA - 2-1/2"	2-1/2"	.69"	1-1/4"	1.5"	2.75"	.5"
95907	HSK100 A 1-1/2"FMA - 2-1/2"	2-1/2"	.94"	1-1/2"	1.88"	3.8"	.63"

CoolBLAST and Standard Face Mill Arbor Screws



CoolBLAST arbor screw provides coolant path.

Features

- Compatible with all coolant thru face mills
- Works with all Techniks face mill arbors
- For coolant up to 1,500 PSI

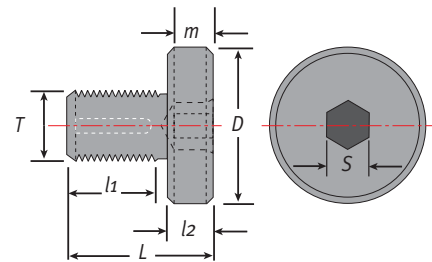

CAT, BT, and HSK CoolBLAST Coolant Arbor Screws

Part No.	Description	Style	Arbor Size	D	L	l1	l2	T	S	m
WF.C1-0.5	CoolBLAST arbor screw 1/2"	B	1/2"	5/8"	.84"	.5"	.34"	1/4"-28UNF	3/16"	.157"
WF.C1-0.75	CoolBLAST arbor screw 3/4"	B	3/4"	7/8"	1.8"	1.4"	.37"	3/8"-24UNF	1/4"	.197"
9851125	CAS-A-0.75 smaller "D"	A	3/4"	5/8"	1.375"	1.0"	.36"	3/8"-24 UNF	1/4"	.37"
WF.C1-1	CoolBLAST arbor screw 1.0"	B	1.0"	1-3/16"	1.4"	0.81"	.37"	1/2"-20UNF	5/16"	.197"
9851135	CAS-A-1.00 smaller "D"	A	1.0"	1.180"	1.375"	1.0"	.38"	1/2"-20UNF	5/16"	.37"
WF.C1-1.25	CoolBLAST arbor screw 1-1/4"	B	1-1/4"	1-1/2"	1.44"	0.94"	.5"	5/8"-18UNF	5/16"	.236"
WF.C1-1.5	CoolBLAST arbor screw 1-1/2"	B	1-1/2"	1-7/8"	1.63"	1.13"	.5"	3/4"-16UNF	3/8"	.276"
WF.C1-2	CoolBLAST arbor screw 2.0"	B	2"	2-1/2"	1.81"	1.31"	.5"	1.0"-14UNF	1/2"	.354"
WF.C1-2.5	CoolBLAST arbor screw 2-1/2"	B	2-1/2"	3-1/8"	2.0"	1.5"	.5"	1.0"-14UNF	1/2"	.354"

CAT, BT, and HSK Standard Arbor Screws

Part No.	Description	Arbor Size	D	L	l1	l2	T	S	m
WF0.5	FMA screw 1/2"	1/2"	5/8"	.84"	.5"	.34"	1/4"-28UNF	3/16"	.157"
WF0.75	FMA screw 3/4"	3/4"	7/8"	1.8"	1.4"	.37"	3/8"-24UNF	1/4"	.197"
WF1	FMA screw 1.0"	1.0"	1-3/16"	1.4"	0.81"	.37"	1/2"-20UNF	5/16"	.197"
WF1.25	FMA screw 1-1/4"	1-1/4"	1-1/2"	1.44"	0.94"	.5"	5/8"-18UNF	5/16"	.236"
WF1.5	FMA screw 1-1/2"	1-1/2"	1-7/8"	1.63"	1.13"	.5"	3/4"-16UNF	3/8"	.276"
WF2	FMA screw 2.0"	2"	2-1/2"	1.81"	1.31"	.5"	1.0"-14UNF	1/2"	.354"
WF2.5	FMA screw 2-1/2"	2-1/2"	3-1/8"	2.0"	1.5"	.5"	1.0"-14UNF	1/2"	.354"

CAT & HSK High-Performance Milling Chucks



Each Techniks High-Performance Milling Chuck is inspected, tested, and certified for quality, accuracy, and holding power. A full lab report is included with each holder.

CoolBLAST Coolant Option



Features

- Each chuck individually tested for holding power
- Nut contacts the flange when properly tightened (prevents overtightening)
- CoolBLAST coolant cap and Black Gold coolant rings for coolant-thru tools

3/4" chuck shown. Use sleeves (page 124) to change tool shank sizes just like collets.

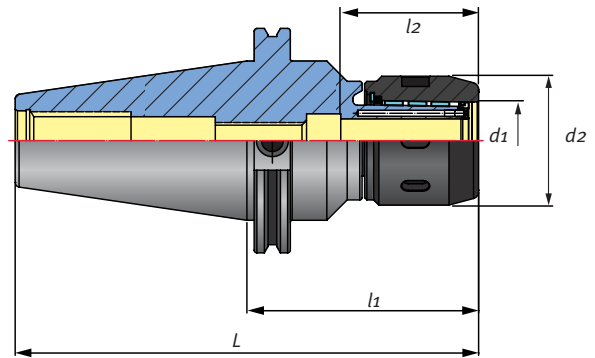

High-Performance 3/4" CAT Milling Chucks

Part No.	Description	L	l1	l2	d1	d2
23202G	CAT40 x MLD 3/4" - 4"	6.69"	4.00"	2.38"	0.75"	2.24"
23214G	CAT50 x MLD 3/4" - 4"	8.00"	4.00"	2.38"	0.75"	2.24"



1-1/4" chuck shown with optional CoolBLAST coolant cap and Black Gold coolant ring. (See next page for details)

Special slotted design (right) of bore I.D. increases holding power and reduces vibration.



High-precision, individually matched needle bearings are symmetrically placed for smooth and reliable operation.

Machined bearing cage ensures accuracy and gripping force.

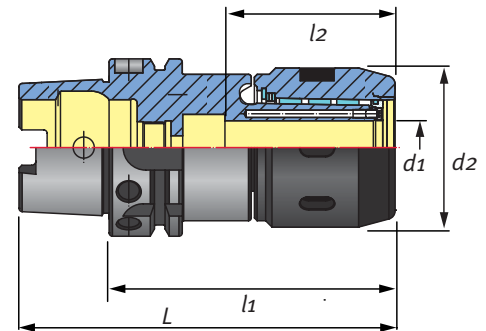
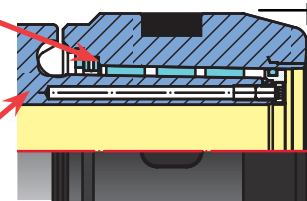

High-Performance 1-1/4" CAT & HSK Milling Chucks

Part No.	Description	L	l1	l2	d1	d2
23210G	CAT40 x MLD 1-1/4" - 4.2"	6.89"	4.20"	2.38"	1.25"	2.80"
23222G	CAT50 x MLD 1-1/4" - 4.13"	8.13"	4.13"	2.38"	1.25"	2.80"
33236G	HSK63A x MLD 1-1/4" - 4.72"	5.98"	4.72"	2.65"	1.25"	2.80"
33256G	HSK100A x MLD 1-1/4" - 4.72"	6.70"	4.72"	2.65"	1.25"	2.79"

CAT40, 50 High-Performance DualDRIVE Milling Chucks



3/4" chuck shown with optional CoolBLAST coolant cap and Black Gold coolant ring.

See an on machine demonstration video of DualDRIVE compared to standard toolholders at: www.techniksusa.com/videos2008/DD

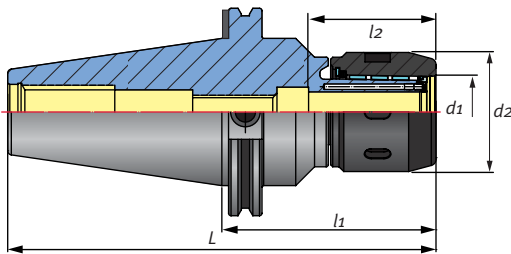

Features

- Use with existing dual-contact machines
- Each chuck individually tested for holding power
- Nut contacts the flange when properly tightened (prevents overtightening)

DualDRIVE For dual contact

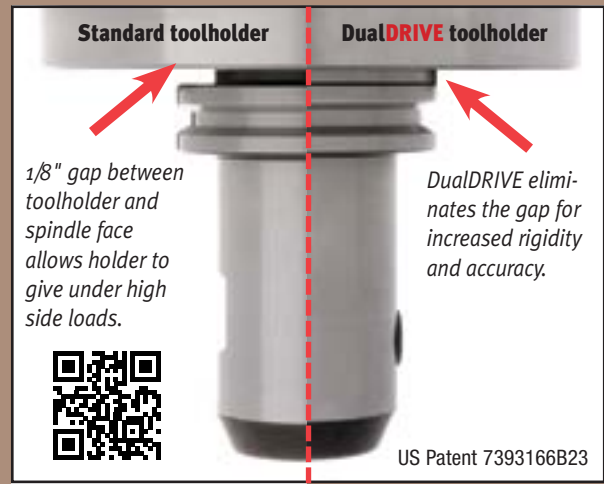

High-Performance Milling Chucks with DualDRIVE

Part No.	Description	L	l1	l2	d1	d2
73202G	CAT40 x MLD 3/4" - 4" DualDRIVE	6.69"	4.00"	2.38"	0.75"	2.24"
73214G	CAT50 x MLD 3/4" - 4" DualDRIVE	8.00"	4.00"	2.38"	0.75"	2.24"
73210G	CAT40 x MLD 1-1/4" - 4.2" DualDRIVE	6.89"	4.20"	2.38"	1.25"	2.80"
73222G	CAT50 x MLD 1-1/4" - 4.13" DualDRIVE	8.13"	4.13"	2.38"	1.25"	2.80"

CoolBLAST Coolant Cap Option

Use CoolBLAST coolant cap and Black Gold ring for coolant-thru tools.

- Maximum chip removal, increase feed rates, extend tool life



Insert Black Gold coolant ring into cap



Cap screws onto end of milling chuck



Remove o-ring for CoolBLAST coolant using standard tools.



Use CoolBLAST coolant cap with Black Gold ER25 or ER40 coolant rings. See page 64

Part No.	Description	Ring
19496G	For 3/4" chuck	ER25
19489G	For 1-1/4" chuck	ER40

Precision Reduction Sleeves for Milling Chucks



Use sleeves to change tool shank sizes just like you would collets.

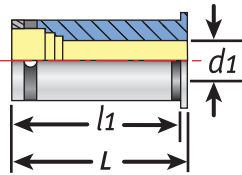

Milling Chuck Reduction Sleeves

- For inch and metric shanks
- T.I.R only .0001"
- All surfaces precision ground for maximum accuracy
- Maximize your milling chuck capability

Special slotted design (right) of bore I.D. increases holding power and reduces vibration.

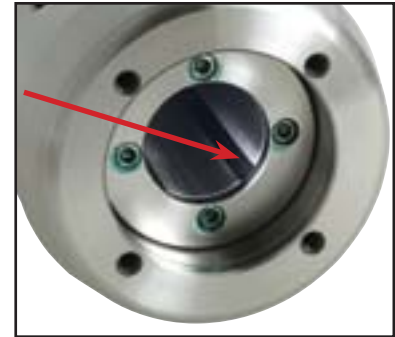

Insert sleeve into chuck, then insert cutting tool, and tighten chuck last.

3/4" O.D. Reduction Sleeves for 3/4" Chucks

Part No.	Description	d1	l1	L
84126-1/8	3/4" O.D., x 1/8" I.D.	1/8"	1.93"	2.09"
84126-3/16	3/4" O.D., x 3/16" I.D.	3/16"	1.93"	2.09"
84126-1/4	3/4" O.D., x 1/4" I.D.	1/4"	1.93"	2.09"
84126-5/16	3/4" O.D., x 5/16" I.D.	5/16"	1.93"	2.09"
84126-3/8	3/4" O.D., x 3/8" I.D.	3/8"	1.93"	2.09"
84126-7/16	3/4" O.D., x 7/16" I.D.	7/16"	1.93"	2.09"
84126-1/2	3/4" O.D., x 1/2" I.D.	1/2"	1.93"	2.09"
84126-9/16	3/4" O.D., x 9/16" I.D.	9/16"	1.93"	2.09"
84126-5/8	3/4" O.D., x 5/8" I.D.	5/8"	1.93"	2.09"
84126-06	3/4" O.D., x 6mm I.D.	6mm	1.93"	2.09"
84126-08	3/4" O.D., x 8mm I.D.	8mm	1.93"	2.09"
84126-10	3/4" O.D., x 10mm I.D.	10mm	1.93"	2.09"
84126-12	3/4" O.D., x 12mm I.D.	12mm	1.93"	2.09"

1-1/4" O.D. Reduction Sleeves for 1-1/4" Chucks

Part No.	Description	d1	l1	L
84127-1/8	1-1/4" O.D., x 1/8" I.D.	1/8"	2.56"	2.75"
84127-3/16	1-1/4" O.D., x 3/16" I.D.	3/16"	2.56"	2.75"
84127-1/4	1-1/4" O.D., x 1/4" I.D.	1/4"	2.56"	2.75"
84127-5/16	1-1/4" O.D., x 5/16" I.D.	5/16"	2.56"	2.75"
84127-3/8	1-1/4" O.D., x 3/8" I.D.	3/8"	2.56"	2.75"
84127-7/16	1-1/4" O.D., x 7/16" I.D.	7/16"	2.56"	2.75"
84127-1/2	1-1/4" O.D., x 1/2" I.D.	1/2"	2.56"	2.75"
84127-9/16	1-1/4" O.D., x 9/16" I.D.	9/16"	2.56"	2.75"
84127-5/8	1-1/4" O.D., x 5/8" I.D.	5/8"	2.56"	2.75"
84127-3/4	1-1/4" O.D., x 3/4" I.D.	3/4"	2.56"	2.75"
84127-7/8	1-1/4" O.D., x 7/8" I.D.	7/8"	2.56"	2.75"
84127-1	1-1/4" O.D., x 1.0" I.D.	1.0"	2.56"	2.75"
84127-08	1-1/4" O.D., x 8mm I.D.	8mm	2.56"	2.75"
84127-10	1-1/4" O.D., x 10mm I.D.	10mm	2.56"	2.75"
84127-12	1-1/4" O.D., x 12mm I.D.	12mm	2.56"	2.75"
84127-14	1-1/4" O.D., x 14mm I.D.	14mm	2.56"	2.75"
84127-16	1-1/4" O.D., x 16mm I.D.	16mm	2.56"	2.75"
84127-20	1-1/4" O.D., x 20mm I.D.	20mm	2.56"	2.75"
84127-25	1-1/4" O.D., x 25mm I.D.	25mm	2.56"	2.75"

Precision CAT and BT Morse Taper Toolholders



Techniks Certified Tooling Features

- Taper ground to AT3 accuracy or better
- .0002" runout from taper to tool pocket
- Each holder lab certified



Tightening
Stands
pg. 206



Retention
Knobs
pg. 200



Wrenches
pg. 204

CAT Morse Taper Toolholders

Part No.	Taper	Size	L1	d1	d2	D
22611	CAT40 Morse Taper	MT#1	1.75"	.475"	.984"	2.5"
22613	CAT40 Morse Taper	MT#2	2."	.7"	1.26"	2.5"
22615	CAT40 Morse Taper	MT#3	2.75"	.937"	1.575"	2.5"
22617	CAT40 Morse Taper	MT#4	3.75"	1.231"	1.889"	2.5"
22623	CAT50 Morse Taper	MT#2	2.36"	.7"	1.26"	3.875"
22625	CAT50 Morse Taper	MT#3	2.56"	.937"	1.575"	3.875"
22627	CAT50 Morse Taper	MT#4	3.75"	1.231"	1.889"	3.875"
22629	CAT50 Morse Taper	MT#5	4.13"	1.75"	2.48"	3.875"

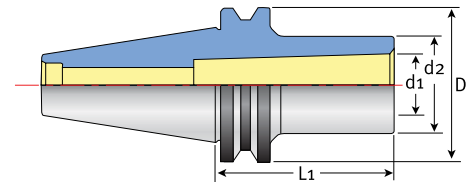

BT Morse Taper Toolholders

Part No.	Taper	Size	L1	d1	d2	D
17001	BT30 Morse Taper	MT#1	1.77"	.475"	.984"	1.811"
17006	BT30 Morse Taper	MT#2	2.36"	.7"	1.26"	1.811"
17010	BT30 Morse Taper	MT#3	3.14"	.937"	1.575"	1.811"
17011	BT40 Morse Taper	MT#1	1.77"	.475"	.984"	2.48"
17014	BT40 Morse Taper	MT#2	1.96"	.7"	1.26"	2.48"
17018	BT40 Morse Taper	MT#3	2.75"	.937"	1.575"	2.48"
17023	BT40 Morse Taper	MT#4	3.75"	1.231"	1.889"	2.48"
17036	BT50 Morse Taper	MT#2	2.36"	.7"	1.26"	3.937"
17039	BT50 Morse Taper	MT#2-135	5.31"	.7"	1.26"	3.937"
17042	BT50 Morse Taper	MT#3	2.56"	.937"	1.575"	3.937"
17046	BT50 Morse Taper	MT3-150	5.9"	.937"	1.575"	3.937"
17048	BT50 Morse Taper	MT#4	3.74"	1.231"	1.889"	3.937"
17051	BT50 Morse Taper	MT4-180	7.08"	1.231"	1.889"	3.937"
17053	BT50 Morse Taper	MT#5	4.13"	1.75"	2.48"	3.937"

Precision Hydraulic Toolholders



Features

- Repeatability, accuracy 3 microns
- Balance 15,000 RPM
- Excellent vibration damping
- Rapid tool changes (no fixture required)



Tightening
Stands
pg. 206



Retention
Knobs
pg. 200



Wrenches
pg. 204



A special groove in the bore captures oil and coolant to improve gripping force.

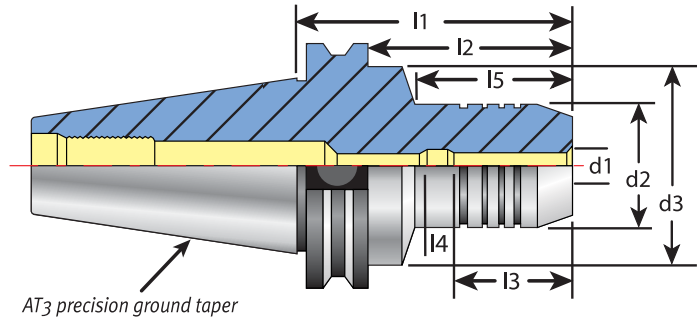

CAT40, CAT50, Hydraulic Toolholders

Part No.	Description	d1	d2	d3	I1	I2	I3	I4	I5
24937	CAT40 Hydro x 20mm	20mm	42mm	44.5mm	82mm	63mm	42mm	10mm	47mm
24954	CAT40 Hydro x 3/4"	3/4"	42mm	44.5mm	82mm	63mm	42mm	10mm	47mm
17954	CAT50 Hydro x 3/4"	3/4"	42mm	70mm	82mm	63mm	42mm	10mm	47mm
17955	CAT50 Hydro x 1-1/4"	1-1/4"	60mm	70mm	91mm	72mm	52mm	10mm	56mm
17937	CAT50 Hydro x 20mm	20mm	42mm	70mm	82mm	63mm	42mm	10mm	47mm

Precision Reduction Sleeves for Hydraulic Toolholders



Features

- Use sleeves with your hydraulic toolholders to run a variety of shank sizes
- T.I.R. of only .00012"
- Sealed to 1,000 P.S.I. for coolant applications

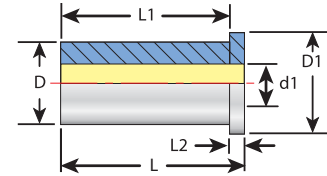

Inch O.D. / Inch I.D. Reduction Sleeves for Hydraulic Toolholders

Part No.	Description	d1	D	D1	L	L1	L2
19474-1/8	3/4" OD - 1/8" ID	.125"	.75"	.945"	2.083"	2.003"	.079"
19474-3/16	3/4" OD - 3/16" ID	.1875"	.75"	.945"	2.083"	2.003"	.079"
19474-1/4	3/4" OD - 1/4" ID	.25"	.75"	.945"	2.083"	2.003"	.079"
19474-5/16	3/4" OD - 5/16" ID	.3125"	.75"	.945"	2.083"	2.003"	.079"
19474-3/8	3/4" OD - 3/8" ID	.375"	.75"	.945"	2.083"	2.003"	.079"
19474-7/16	3/4" OD - 7/16" ID	.4375"	.75"	.945"	2.083"	2.003"	.079"
19474-1/2	3/4" OD - 1/2" ID	.5"	.75"	.945"	2.083"	2.003"	.079"
19474-5/8	3/4" OD - 5/8" ID	.625"	.75"	.945"	2.083"	2.003"	.079"
19478-1/4	1-1/4" OD - 1/4" ID	.25"	1.25"	1.575"	2.598"	2.441"	.157"
19478-5/16	1-1/4" OD - 5/16" ID	.3125"	1.25"	1.575"	2.598"	2.441"	.157"
19478-3/8	1-1/4" OD - 3/8" ID	.375"	1.25"	1.575"	2.598"	2.441"	.157"
19478-1/2	1-1/4" OD - 1/2" ID	.5"	1.25"	1.575"	2.598"	2.441"	.157"
19478-5/8	1-1/4" OD - 5/8" ID	.625"	1.25"	1.575"	2.598"	2.441"	.157"
19478-3/4	1-1/4" OD - 3/4" ID	.75"	1.25"	1.575"	2.598"	2.441"	.157"
19478-7/8	1-1/4" OD - 7/8" ID	.875"	1.25"	1.575"	2.598"	2.441"	.157"
19478-01	1-1/4" OD - 1" ID	1.0"	1.25"	1.575"	2.598"	2.441"	.157"

Metric O.D. / Inch I.D. Reduction Sleeves for Hydraulic Toolholders

Part No.	Description	d1	D	D1	L	L1	L2
19462-1/4	20mm OD - 1/4" ID	.25"	20mm	24mm	52.9mm	50.9mm	2mm
19462-5/16	20mm OD - 5/16" ID	.3125"	20mm	24mm	52.9mm	50.9mm	2mm
19462-3/8	20mm OD - 3/8" ID	.375"	20mm	24mm	52.9mm	50.9mm	2mm
19462-7/16	20mm OD - 7/16" ID	.4375"	20mm	24mm	52.9mm	50.9mm	2mm
19462-1/2	20mm OD - 1/2" ID	.5"	20mm	24mm	52.9mm	50.9mm	2mm
19462-5/8	20mm OD - 5/8" ID	.625"	20mm	24mm	52.9mm	50.9mm	2mm

Metric O.D. / Metric I.D. Reduction Sleeves for Hydraulic Toolholders

Part No.	Description	d1	D	D1	L	L1	L2
19462-06	20mm OD - 6mm ID	6mm	20mm	24mm	52.90mm	50.9mm	2mm
19462-08	20mm OD - 8mm ID	8mm	20mm	24mm	52.90mm	50.9mm	2mm
19462-10	20mm OD - 10mm ID	10mm	20mm	24mm	52.90mm	50.9mm	2mm
19462-12	20mm OD - 12mm ID	12mm	20mm	24mm	52.90mm	50.9mm	2mm
19462-14	20mm OD - 14mm ID	14mm	20mm	24mm	52.90mm	50.9mm	2mm
19462-16	20mm OD - 16mm ID	16mm	20mm	24mm	52.90mm	50.9mm	2mm

CAT40 and CAT50 SIMIS ER Collet Chucks

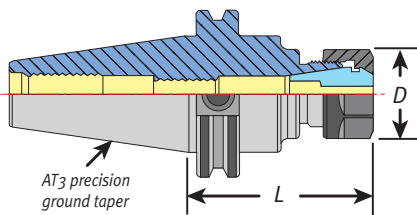

Comparison of SIMIS and Techniks Certified Collet Chucks

	SIMIS	Techniks Certified
Lab Certified for Accuracy & Balance	NO	YES
Collet Nut Included	YES - Uncoated	YES - PowerCOAT
Balance Specification	18,000 RPMs	25,000 RPMs
DIN B Coolant Available	NO	YES
Available Sizes	Most Common	Wide Selection

ER Nut Included



Part No.	Description
11116	ER16 uncoated hex nut
11120	ER20 uncoated hex nut
11125	ER25 uncoated slotted nut
11132	ER32 uncoated slotted nut
11140	ER40 uncoated slotted nut

CAT40 ER Toolholders

Part No.	Description	L	D	Collet	Max. Shank	Stop Screw	Wrench
CAT40ER11-3	CAT40 x ER11-3"	3	.748"	ER11	.275"	06081	04608
CAT40ER11-4	CAT40 x ER11-4"	4	.748	ER11	.275"	06081	04608
CAT40ER11-6	CAT40 x ER11-6"	6	.748	ER11	.275"	06081	04608
CAT40ER16-2.76	CAT40 x ER16-2.76"	2.76"	1.08"	ER16	.406"	06083	04609 hex
CAT40ER16-4	CAT40 x ER16-4"	4"	1.08"	ER16	.406"	06083	04609 hex
CAT40ER20-2.76	CAT40 x ER20-2.76"	2.76"	1.34"	ER20	.512"	06087	04610 hex
CAT40ER20-4	CAT40 x ER20-4"	4"	1.34"	ER20	.512"	06087	04610 hex
CAT40ER20-6	CAT40 x ER20-6"	6"	1.34"	ER20	.512"	06087	04610 hex
CAT40ER25-2.76	CAT40 x ER25-2.76"	2.76"	1.65"	ER25	.63"	06089	04615
CAT40ER25-4	CAT40 x ER25-4"	4"	1.65"	ER25	.63"	06089	04615
CAT40ER32-2.76	CAT40 x ER32-2.76"	2.76"	1.97"	ER32	.788"	06089	04616
CAT40ER32-4	CAT40 x ER32-4"	4"	1.97"	ER32	.788"	06089	04616
CAT40ER40-3.15	CAT40 x ER40-3.15"	3.15"	2.48"	ER40	1.023"	06091	04617

CAT50 ER Toolholders

Part No.	Description	L	D	Collet	Max. Shank	Stop Screw	Wrench
CAT50ER16-4	CAT50 x ER16-4	4"	1.08"	ER16	.406"	06083	04609 hex
CAT50ER16-6	CAT50 x ER16-6	6"	1.08"	ER16	.406"	06083	04609 hex
CAT50ER20-4	CAT50 x ER20-4	4"	1.34"	ER20	.512"	06087	04610 hex
CAT50ER20-6	CAT50 x ER20-6	6"	1.34"	ER20	.512"	06087	04610 hex
CAT50ER32-4	CAT50 x ER32-4	4"	1.97"	ER32	.788"	06089	04616
CAT50ER32-6	CAT50 x ER32-6	6"	1.97"	ER32	.788"	06089	04616
CAT50ER40-4	CAT50 x ER40-4	4"	2.48"	ER40	1.023"	06091	04617

CAT40 and CAT50 SIMIS End Mill Holders



Comparison of SIMIS and Techniks Certified Endmill Holders

	SIMIS	Techniks Certified
Lab Certified for Accuracy & Balance	NO	YES
Balance Specification	8,000 RPMs	10,000 RPMs
DIN B Coolant Available	NO	YES
End Mill Bore Tolerance	H7	H5
Available Sizes	Most Common	Wide Selection



Tightening
Stands
pg. 206



Retention
Knobs
pg. 200



Wrenches
pg. 204

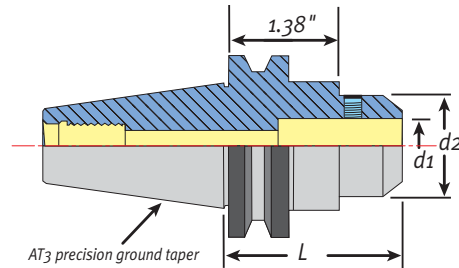

CAT40 End Mill Holders

Part No.	Description – d1	L	d2
CAT40SLN1/8	CAT40 x SLN - 1/8"	2.375"	.69"
CAT40SLN3/16	CAT40 x SLN - 3/16"	2.5"	.69"
CAT40SLN1/4	CAT40 x SLN - 1/4"	3"	.78"
CAT40SLN1/4-1.75	CAT40 x SLN - 1/4"	1.75"	.795"
CAT40SLN3/8	CAT40 x SLN - 3/8"	3"	.88"
CAT40SLN3/8-1.75	CAT40 x SLN - 3/8"	1.75"	.88"
CAT40SLN1/2	CAT40 x SLN - 1/2"	3"	1.25"
CAT40SLN1/2-1.75	CAT40 x SLN - 1/2"	1.75"	1.5"
CAT40SLN5/8	CAT40 x SLN - 5/8"	3"	1.5"
CAT40SLN3/4	CAT40 x SLN - 3/4"	3.5"	1.75"
CAT40SLN3/4-1.75	CAT40 x SLN - 3/4"	1.75"	1.75"
CAT40SLN1	CAT40 x SLN - 1.0"	4"	2"
CAT40SLN1-1.75	CAT40 x SLN - 1.0"	1.75"	1.75"
CAT40SLN1 1/4-2	CAT40 x SLN - 1-1/4"	2"	1.75"

CAT50 Endmill Holders

Part No.	Description – d1	d2	L
CAT50SLN1/4	CAT50 x SLN - 1/4"	.78	4"
CAT50SLN3/8	CAT50 x SLN - 3/8"	1.0"	4"
CAT50SLN1/2	CAT50 x SLN - 1/2"	1.25"	4"
CAT50SLN5/8	CAT50 x SLN - 5/8"	1.5"	4"
CAT50SLN3/4	CAT50 x SLN - 3/4"	1.75"	4"
CAT50SLN1	CAT50 x SLN - 1.0"	2"	4"
CAT50SLN11/4	CAT50 x SLN - 1-1/4"	2.5"	4.6"

Keyless Drill Chucks



Our HP3 High-Precision Drill Chucks have the flexibility to hold a wide range of shank sizes and deliver superior performance too. Maximum runout (T.I.R.) is only .0008".

They also feature a one-piece design that provides greater rigidity and safety because the chuck cannot break free during operation.



CAT and BT SPU Drill Chucks

Part No.	Description	l1	L	D	d1
22403	CAT40 SPU x 1/2" - 4"	101.6mm	169.9mm	63.5mm	50mm
22405	CAT50 SPU x 1/2" - 4"	101.6mm	203.2mm	98.4mm	50mm
16456-W	BT30 x SPU x 13mm - 110mm (no slots)	110mm	170.4mm	46mm	50mm
06456	BT30 x SPU x 13mm - 110mm	110mm	170.4mm	46mm	50mm
16466	BT40 x SPU x 13mm - 100mm	100mm	177.4mm	63mm	50mm
06476	BT50 x SPU x 13mm - 100mm	100mm	213.8mm	100mm	50mm
01250-13S	SPU drill chuck wrench (replacement)				

Features

- For milling machines & drilling machines
- All hardened parts for long life and safety
- Use with CAT or BT holders (opposite)

Keyless Jacobs Taper Drill Chucks

Part No.	Description	Length Closed	Outer Diameter	Range
02150	08S x JT1	76mm	38mm	0 - 5/16"
02153	13S x JT6	102mm	49mm	0 - 1/2"
02151-JT33	10S x JT33	92mm	43mm	0 - 3/8"
02153-JT33	13S x JT33	102mm	49mm	0 - 1/2"

Features

- Capacity from 1/16" to 1/2"
- 4 times greater holding power
- Balanced to 10,000 RPM

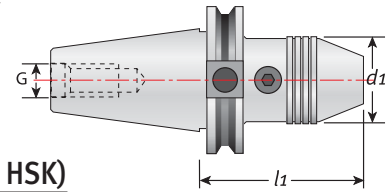

HP3 Precision Drill Toolholders (ISO, BT, HSK)

Part No.	Description	d1	l1	G
171.05.046.003	HSK63F HP3 drill chuck 1/2"	50	123.5	-
64.05.046.051	ISO30 HP3 drill chuck 1/2"	50	103	M12
67.05.046.001	BT30 HP3 drill chuck 1/2"	50	92.5	M12
39.05.046.001	BT40 HP3 drill chuck 1/2"	50	95.5	M16

Features

- 3 times more holding power than other chucks
- Holds non-standard shank sizes up to 1/2"
- Replaceable chuck is held by a drawbolt

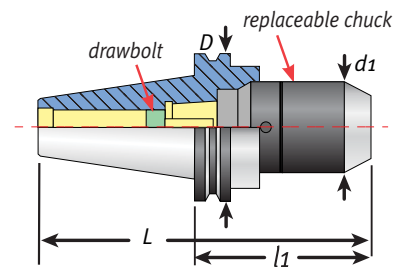

CAT and BT Toolholders For Jacobs Taper Drill Chucks



Features

- Better T.I.R. and rigidity than standard drill chucks
- Taper ground to AT3 accuracy
- Use with keyless Jacobs chucks

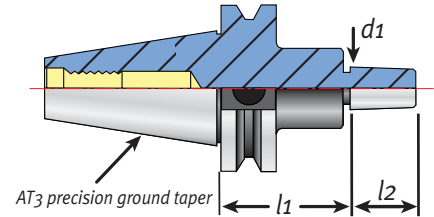

CAT Toolholders For Jacobs Taper Drill Chucks

Part No.	Description	l1	l2	d1	Jacobs Taper
22511	CAT40 x JT2 - 1.57"	1.57"	.875"	.559"	2
22512	CAT40 x JT3 - 1.57"	1.57"	1.2"	.811"	3
22513	CAT40 x JT6 - 1.57"	1.57"	.945"	.676"	6
22515	CAT40 x JT33 - 1.57"	1.57"	.945"	.624"	33
22521	CAT50 x JT2 - 1.57"	1.57"	.875"	.559"	2
22527	CAT50 x JT3 - 1.57"	1.57"	1.2"	.811"	3
22529	CAT50 x JT4 - 1.57"	1.57"	1.656"	1.124"	4
22531	CAT50 x JT5 - 1.57"	1.57"	1.875"	1.413"	5
22523	CAT50 x JT6 - 1.57"	1.57"	.945"	.676"	6
22525	CAT50 x JT33 - 1.57"	1.57"	.945"	.624"	33

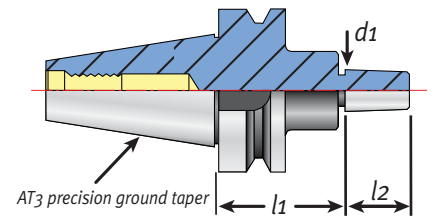

BT Toolholders For Jacobs Taper Drill Chucks

Part No.	Description	l1	l2	d1
16502	BT30 x JT2 - 45mm	45mm	20mm	14.199
16504	BT30 x JT33 - 45mm	45mm	24mm	15.850
16506	BT30 x JT6 - 45mm	45mm	24mm	17.170
16522	BT40 x JT2 - 45mm	45mm	20mm	14.199
16523	BT40 x JT33 - 45mm	45mm	24mm	15.850
16524	BT40 x JT6 - 45mm	45mm	24mm	17.170
16542	BT50 x JT2 - 45mm	45mm	20mm	14.199
16543	BT50 x JT33 - 45mm	45mm	24mm	15.850
16544	BT50 x JT6 - 45mm	45mm	24mm	17.170

Measurement Guide For Special Order Toolholders

V-flange CNC machine make, model and spindle

V-Flange tool #1 dimensions

D = _____
 F = _____
 W = _____
 A = _____
 N = _____

V-Flange tool #2 dimensions

D = _____
 F = _____
 W = _____
 A = _____
 N = _____

HSK CNC machine make, model and spindle

HSK tool #1 dimensions

D = _____
 F = _____
 W = _____
 A = _____
 N = _____

HSK tool #2 dimensions

D = _____
 F = _____
 W = _____
 A = _____
 N = _____

Fill in all the required dimensions (left).
 Then, fax or phone in your order for a fast quote.

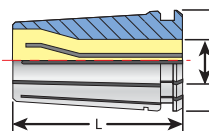
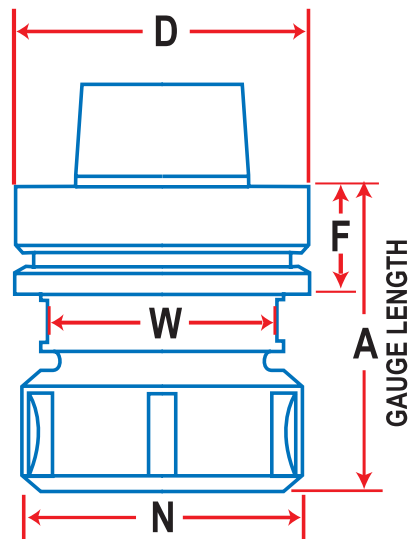
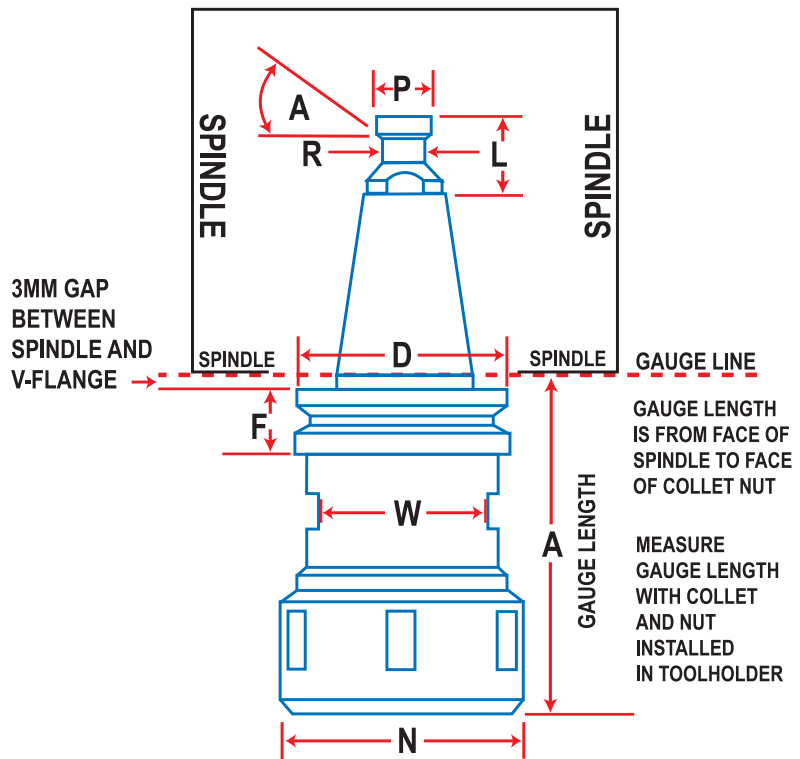

For special order collets see page 72.

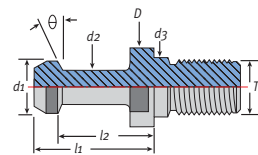

Call for special order retention knobs.

Quick-Change Tap Chucks and Collets

New!

MicroFLOAT Modular Tapping

Uses a compression float to compensate for sensitive taps and hard to start taps. Extensions for tapping at extended lengths.

Increase Tap Life 295%



Tired of Breaking Taps?

Our Tension-Compression tap holders automatically compensate for machine feed rates to improve results.



Rigid Tap Chucks

Easy to use and reliable tap holders for general tapping applications.



ANSI Clutch Drive & Rigid Tap Collets

Clutch drive automatically stops spinning if tap reaches bottom of hole preventing broken taps.



Built for Speed.

Introducing! – MicroFLOAT Tapping System



Up to 9" of extension with all MicroFLOAT modular parts

MicroFLOAT is the most flexible, modular tapping system available.

MicroFLOAT Modular Tapping System For Extended Lengths

The MicroFLOAT Tapping System was designed to increase tap life, decrease scrap and reduce tap breakage. This revolutionary idea was born out of Techniks' many years of experience in tapping adapters. We created a system that uses the best features of all tapping systems: long tool life, quick change, thread accuracy for extended time and reduced tap breakage.

Techniks MicroFLOAT tap adapters feature 0.008" of compression for hard to start or sensitive taps, and 0.040" of tension (extension) to compensate for any inaccuracy in the machine, taps, or associated tooling and fixturing.

Optimal tapping performance is achieved when the tap follows the exact same path out as it did when it cut the threads. Any deviation causes the tap to "drag" resulting in premature tap wear and the possibility of the threads being out of tolerance. Techniks MicroFLOAT provides improved tap life and threading results.

How the System Works

This system works much like the other high quality quick change tap adapters in our catalog. To change taps, pull the outside sleeve away from the v-flange to release the tap adapter in the toolholder so it can be changed or extensions can be added.



MicroFLOAT Tap Chuck (CAT40 shown)

ER16/25 Quick Change Adapter

Advantages

- Great for older machines with backlash in spindle
- Great for production tapping
- Great for high tolerance tapping

MicroFLOAT Tension / Compression

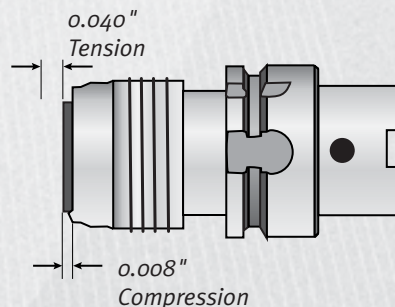

High-Pressure Coolant Enabled



coolant-thru tool

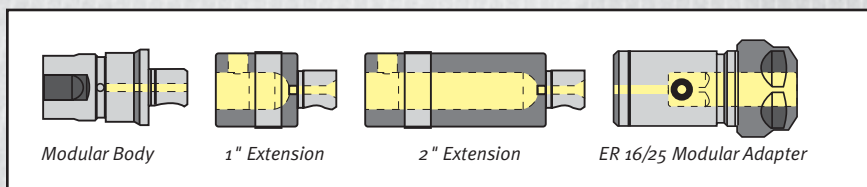

NOTE:

ER16 adapter takes up to 3/8" tap.

ER25 takes up to 3/4" tap.

295% Productivity Increase / MicroFLOAT Case-Study



Case-Study Shows MicroFLOAT System Increases Tap Life by 295%

Techniks recently conducted a case-study comparing tapping using a rigid tap system and the new MicroFLOAT Tapping System.

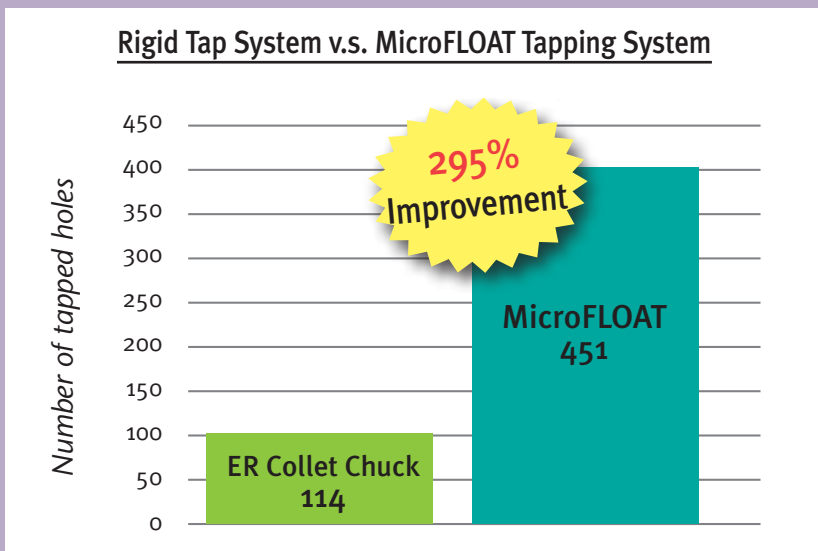

Case-Study Working Parameters

Material: AISI 304

Speeds and Feeds:

$V_t = 12 \text{ m/min}$

$A_v = 1 \text{ mm/rev}$

$\text{prof} = 12 \text{ mm}$

Test Results:

Tapped holes with rigid tap system until tap breakage: 114

Tapped holes MicroFLOAT until tap breakage: 451

295% Improvement!

Directions for Use

1. Select the MicroFLOAT chuck required for your machine spindle (see page 136)
2. Select the ER adapter size and number of extensions needed for your tapping application. (see page 137)
3. To change taps, pull the outside sleeve away from the v-flange to release the tap adapter in the toolholder so it can be changed or extensions added.
4. Start tapping at 100% of pitch feed. If issues occur, program 3-5% below the pitch feed. This will engage more tension to ensure the tap does not "drag" coming out.

CAT, BT, HSK, MicroFLOAT Tap Chucks and ER Adapters



Use MicroFLOAT chucks with ER Tap Adapters

Features & Benefits

- Compensates for sensitive and hard to start taps
- Great for high pressure coolant applications
- Decreases cost by increasing tap life, decreasing scrap, and reducing tap breakage



Tightening
Stands
pg. 206



Retention
Knobs
pg. 200



Wrenches
pg. 204

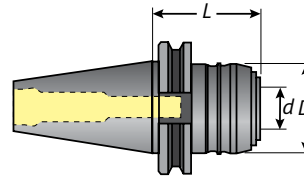

CAT40 & 50 MicroFLOAT Tap Chucks

Part No.	Description	L	D	d
23400-40CAT	CAT40 MicroFLOAT #1	2.75"	1.7"	0.79"
23600-40CAT	CAT40 MicroFLOAT #2	2.75"	2.36"	1.26"
23400-50CAT	CAT50 MicroFLOAT #1	3.54"	1.7"	0.79"
23600-50CAT	CAT50 MicroFLOAT #2	3.54"	2.36"	1.26"

BT30 & 40 MicroFLOAT Tap Chucks

Part No.	Description	L	D	d
23400-30BT	BT30 MicroFLOAT #1	2.09"	1.7"	0.79"
23400-40BT	BT40 MicroFLOAT #1	2.40"	1.7"	1.26"
23600-40BT	BT40 MicroFLOAT #2	3.22"	2.36"	1.26"

HSK63A MicroFLOAT Tap Chucks

Part No.	Description	L	D	d
23400-H63A	HSK63A MicroFLOAT #1	2.52"	1.7"	.79"

Straight Shank MicroFLOAT Chucks

Part No.	Description	L	D	d
23400-INC1	1" SS MicroFLOAT # 1	1.3"	1.7"	0.79"
23600-INC1	1" SS MicroFLOAT # 2	2.13"	2.36"	1.26"

ER Tap Adapter – Required

Part No.	Description	L	D	d
23410-ER16	ER16 MicroFLOAT 1 Adapter	2.16"	1.10"	.79"
23610-ER25	ER25 MicroFLOAT 2 Adapter	3.39"	1.65"	1.27"

High-Pressure Coolant Enabled



Coolant-thru tool is a standard feature on MicroFLOAT tap chucks



MicroFLOAT straight shank chuck

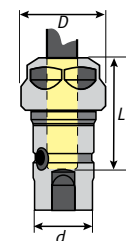
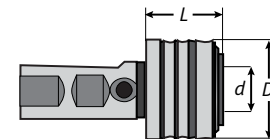

ER16 adapter takes up to 3/8" tap
ER25 takes up to 3/4" tap

MicroFLOAT Modular Tap Extensions



Use modular extensions to build gage lengths up to 9".



Use modular bodies when you use extensions.

Modular Body

Part No.	Description	L	D	d
23411-MOD	Modular Body MicroFLOAT #1	.20"	.91"	.79"
23611-MOD	Modular Body MicroFLOAT #2	.28"	1.38"	1.26"



1" extension



2" extension

Modular Extensions

Part No.	Description	L	D	Chuck
42150-25	1" Modular Extension MicroFLOAT #1	.98"	.91"	23400-..
42150-50	1" Modular Extension MicroFLOAT #1	1.97"	.91"	23400-..
42250-50	2" Modular Extension MicroFLOAT #2	1.97"	1.38"	23600-..
42250-100	2" Modular Extension MicroFLOAT #2	3.94"	1.38"	23600-..



ER16 Modular Adapter

ER16 adapter takes up to 3/8" tap
ER25 takes up to 3/4" tap

ER Modular Adapter

Part No.	Description	L	D	d
42147-ER16	ER16 Modular Adapter MicroFLOAT #1	1.97"	1.10"	.91"
42247-ER25	ER25 Modular Adapter MicroFLOAT #2	3.11"	1.65"	1.38"

Directions for Use

1. Select the MicroFLOAT chuck required for your machine spindle (see previous page)
2. Select the modular adapter size and number of extensions needed for your tapping application.
3. Start tapping at 100% of pitch feed. If issues occur, program 3-5% below the pitch feed. This will engage more tension to ensure the tap does not "drag" coming out.

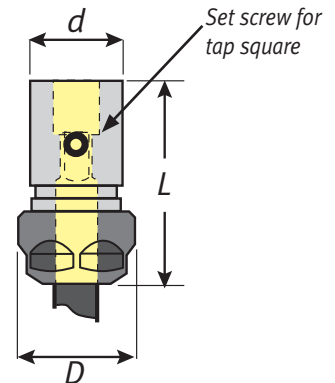
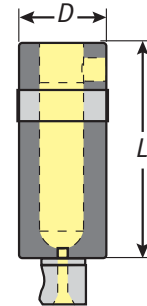
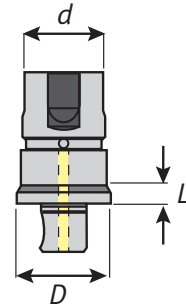

CAT, BT Tension / Compression Tap Holders



Techniks Quality Features

- Adjustable compression helps start difficult taps
- Taper ground to AT₃ accuracy or better
- Quick-Change Style



ANSI Tap
Collets
pg. 142



Tightening
Stands
pg. 206



Retention
Knobs
pg. 200



Wrenches
pg. 204

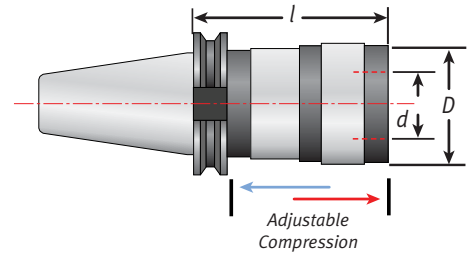

CAT Tension / Compression Tap Holders

Part No.	Description	d	D	l	Size	Tap	Compensation	
						Capacity	Tension	Compression
32400/40CAT	CAT40 T/C Holder, Size 1	0.748"	1.5"	2.36"	1	0 – 9/16"	0.35"	0.35"
32400/50CAT	CAT50 T/C Holder, Size 1	0.748"	1.5"	2.44"	1	0 – 9/16"	0.35"	0.35"
32600/40CAT	CAT40 T/C Holder, Size 2	1.220"	2.17"	3.94"	2	5/16 – 7/8"	0.59"	0.59"
32600/50CAT	CAT50 T/C Holder, Size 2	1.220"	2.17"	3.27"	2	5/16 – 7/8"	0.59"	0.59"
32800/40CAT	CAT40 T/C Holder, Size 3	1.890"	3.11"	5.43"	3	1/2 – 1-3/8"	0.94"	0.94"
32800/50CAT	CAT50 T/C Holder, Size 3	1.890"	3.11"	5.24"	3	1/2 – 1 3/8"	0.94"	0.94"
32900/40CAT	CAT40 T/C Holder, Size 4	2.362"	3.86"	6.06"	4	1-7/16 – 1-7/8"	1.02"	1.02"
32900/50CAT	CAT50 T/C Holder, Size 4	2.362"	3.86"	5.79"	4	1-7/16 – 1-7/8"	1.02"	1.02"

BT Tension / Compression Tap Holders

Part No.	Description	d	D	l	Size	Tap	Compensation	
						Capacity	Tension	Compression
32400/30BT	BT30 T/C Holder, Size 1	0.748"	1.5"	2.48"	1	0 – 9/16"	0.35"	0.35"
32400/40BT	BT40 T/C Holder, Size 1	0.748"	1.5"	2.68"	1	0 – 9/16"	0.35"	0.35"
32400/50BT	BT50 T/C Holder, Size 1	0.748"	1.5"	3.15"	1	0 – 9/16"	0.35"	0.35"
32600/30BT	BT30 T/C Holder, Size 2	1.220"	2.17"	3.78"	2	5/16 – 7/8"	0.59"	0.59"
32600/40BT	BT40 T/C Holder, Size 2	1.220"	2.17"	3.66"	2	5/16 – 7/8"	0.59"	0.59"
32600/50BT	BT50 T/C Holder, Size 2	1.220"	2.17"	4.02"	2	5/16 – 7/8"	0.59"	0.59"
32800/40BT	BT40 T/C Holder, Size 3	1.890"	3.11"	5.43"	3	1/2 – 1-3/8"	0.94"	0.94"
32800/50BT	BT50 T/C Holder, Size 3	1.890"	3.11"	5.31"	3	1/2 – 1-3/8"	0.94"	0.94"
32900/40BT	BT40 T/C Holder, Size 4	2.362"	3.86"	6.18"	4	1-7/16 – 1-7/8"	1.02"	1.02"
32900/50BT	BT50 T/C Holder, Size 4	2.362"	3.86"	5.79"	4	1-7/16 – 1-7/8"	1.02"	1.02"

HSK & Straight Shank Tension / Compression Tap Holders



Techniks Quality Features

- Adjustable compression helps start difficult taps
- Quick-Change Style

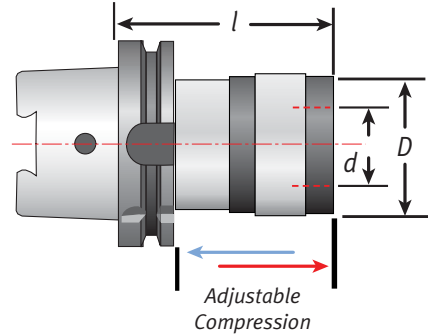

HSK A Tension / Compression Tap Holders

Part No.	Description	d	D	l	Size	Tap	Compensation	
						Capacity	Tension	Compression
34400/H40A	HSK40A T/C Holder, Size 1	0.748"	1.61"	3.14"	1	0 – 9/16"	0.295"	0.295"
34400/H50A	HSK50A T/C Holder, Size 1	0.748"	1.61"	2.83"	1	0 – 9/16"	0.295"	0.295"
34400/H63A	HSK63A T/C Holder, Size 1	0.748"	1.61"	2.83"	1	0 – 9/16"	0.295"	0.295"
34400/H100A	HSK100A T/C Holder, Size 1	0.748"	1.61"	3.14"	1	0 – 9/16"	0.295"	0.295"
34600/H50A	HSK50A T/C Holder, Size 2	1.22"	2.36"	4.33"	2	5/16 – 7/8"	0.393"	0.393"
34600/H63A	HSK63A T/C Holder, Size 2	1.22"	2.36"	4.33"	2	5/16 – 7/8"	0.393"	0.393"
34600/H100A	HSK100A T/C Holder, Size 2	1.22"	2.36"	3.94"	2	5/16 – 7/8"	0.393"	0.393"

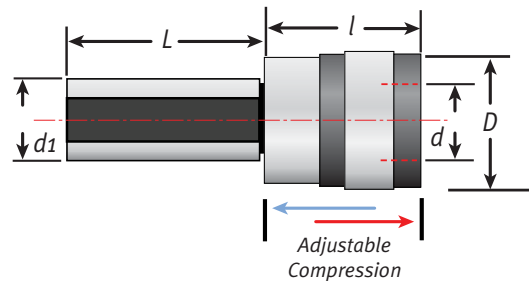

Straight Shank Tapping Chucks

Part No.	Description	D1	D	l	L	Tap	Compensation	
						Capacity	Tension	Compression
32400/INC1	1" shank T/C Holder, Size 1	1.00"	1.61"	1.76"	1.95"	0 – 9/16"	0.35"	0.35"
32600/INC1	1" shank T/C Holder, Size 2	1.00"	2.36"	2.52"	2.00"	5/16 – 7/8"	0.59"	0.59"
32600/INC1-1/2	1 1/2" shank T/C Holder, Size 2	1.50"	2.36"	2.52"	3.50"	5/16 – 7/8"	0.59"	0.59"
32800/INC1-1/2	1 1/2" shank T/C Holder, Size 3	1.50"	3.38"	3.85"	3.50"	1/2 – 1 3/8"	0.94"	0.94"

CAT, BT Rigid Tap Holders



Techniks Quality Features

- Taper ground to AT₃ accuracy or better
- Quick-Change Style



ANSI Tap Collets
pg. 142



Tightening Stands
pg. 206



Retention Knobs
pg. 200



Wrenches
pg. 204

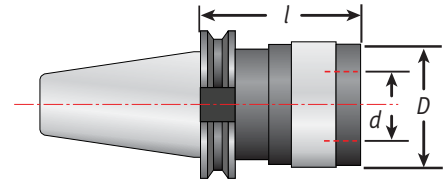

CAT Rigid Tap Holders

Part No.	Description	l	D	d	Size	Tap Capacity
21480/40CAT	CAT40 Rigid Tap Holder, Size 1	2.32"	1.31"	0.748"	1	0 – 9/16"
21480/50CAT	CAT50 Rigid Tap Holder, Size 1	2.95"	1.31"	0.748"	1	0 – 9/16"
21680/40CAT	CAT40 Rigid Tap Holder, Size 2	3.23"	1.97"	1.22"	2	5/16 – 7/8"
21680/50CAT	CAT50 Rigid Tap Holder, Size 2	3.86"	1.97"	1.22"	2	5/16 – 7/8"
21880/40CAT	CAT40 Rigid Tap Holder, Size 3	4.80"	2.83"	1.89"	3	1/2 – 1 3/8"
21880/50CAT	CAT50 Rigid Tap Holder, Size 3	4.80"	2.83"	1.89"	3	1/2 – 1-3/8"

BT Rigid Tap Holders

Part No.	Description	l	D	d	Size	Tap Capacity
21480/30BT	BT30 Rigid Tap Holder, Size 1	2.80"	1.31"	0.748"	1	0 - 9/16"
21480/40BT	BT40 Rigid Tap Holder, Size 1	2.63"	1.31"	0.748"	1	0 - 9/16"
21480/50BT	BT50 Rigid Tap Holder, Size 1	3.07"	1.31"	0.748"	1	0 - 9/16"
21680/30BT	BT30 Rigid Tap Holder, Size 2	3.70"	1.97"	1.22"	2	5/16 - 7/8"
21680/40BT	BT40 Rigid Tap Holder, Size 2	3.54"	1.97"	1.22"	2	5/16 - 7/8"
21680/50BT	BT50 Rigid Tap Holder, Size 2	3.97"	1.97"	1.22"	2	5/16 - 7/8"
21880/40BT	BT40 Rigid Tap Holder, Size 3	4.61"	2.83"	1.89"	3	1/2 - 1 3/8"
21880/50BT	BT50 Rigid Tap Holder, Size 3	4.80"	2.83"	1.89"	3	1/2 - 1 3/8"

HSK and Straight Shank Rigid Tap Holders



Techniks Quality Features

- Quick-Change Style

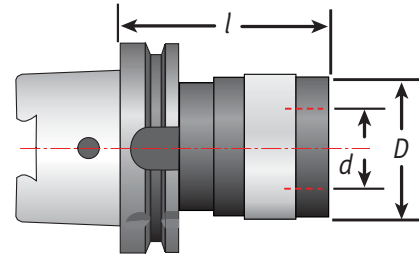

HSK Rigid Tap Holders

Part No.	Description	l	D	d	Size	Tap Capacity
21480/H50A	HSK50A Rigid Tap Holder, Size 1	2.30"	1.31"	0.748"	1	0 - 9/16"
21480/H63A	HSK63A Rigid Tap Holder, Size 1	2.32"	1.31"	0.748"	1	0 - 9/16"
21480/H100A	HSK100A Rigid Tap Holder, Size 1	2.95"	1.31"	0.748"	1	0 - 9/16"
21680/H50A	HSK50A Rigid Tap Holder, Size 2	3.23"	1.97"	1.22"	2	5/16 - 7/8"
21680/H63A	HSK63A Rigid Tap Holder, Size 2	3.23"	1.97"	1.22"	2	5/16 - 7/8"
21680/H100A	HSK100A Rigid Tap Holder, Size 2	3.86"	1.97"	1.22"	2	5/16 - 7/8"
21880/H63A	HSK63A Rigid Tap Holder, Size 3	4.80"	2.83"	1.89"	3	1/2 - 1 3/8"
21880/H100A	HSK100A Rigid Tap Holder, Size 3	4.80"	2.83"	1.89"	3	1/2 - 1 3/8"

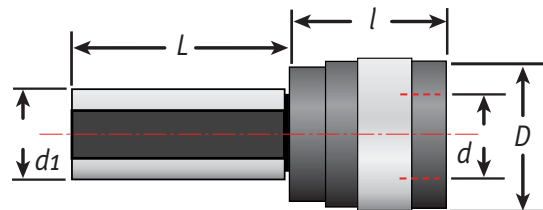

Straight Shank Rigid Tap Holders

Part No.	Description	d1	L	l	D	d	Tap Capacity
21480/INC1	1" shank, Rigid Tap Holder, Size 1	1.00"	1.95"	1.60"	1.61"	.748"	0 - 9/16"
21680/INC1	1" shank, Rigid Tap Holder, Size 2	1.00"	2.00"	2.50"	2.36"	1.22"	3/8 - 7/8"
21880/INC1-1/2	1 1/2" shank, Rigid Tap Holder, Size 3	1.50"	3.50"	3.44"	3.38"	1.89"	1/2 - 1 3/8"

ANSI Clutch Drive Tap Collets



Note: Metric tap collets available on request. Please verify shank diameter when ordering metric tap collets.

ANSI Clutch Drive Tap Collet Features

- Prevents broken taps
- Automatically stops spinning when bottom is reached
- Change worn taps in seconds

Dimensions	A	B	C	D	E
Size 0	.51"	.77"	.83"	.91"	.24"
Size 1	.75"	.85"	.98"	1.26"	.31"
Size 2	1.22"	1.38"	1.34"	1.97"	.16"
Size 3	1.89"	2.19"	1.77"	2.83"	.04"

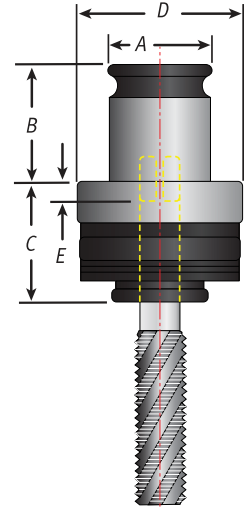

Collet Set

Part No.	Description
48/3-SET	Size 3, 16 piece set – 1/2" thru 1" NPT

ANSI Clutch Drive Tap Collets

ANSI	Metric Tap With ANSI Shank	Shank	SQ	Size 0	Size 1	Size 2	Size 3
0-6"	M1.6-M3.5	0.141"	0.110"	13/0-4036	19/1-4036		
8, 5/32"	M4	0.168"	0.131"	13/0-4041	19/1-4041		
10, 3/16"	M4.5, M5	0.194"	0.152"	13/0-4048	19/1-4048		
12, 7/32"		0.220"	0.165"	13/0-4054	19/1-4054		
1/4"	M6, M6.3	0.255"	0.191"	13/0-4063	19/1-4063		
5/16"	M7, M8	0.318"	0.238"		19/1-4079	31/2-4079	
3/8"	M10	0.381"	0.286"		19/1-4095	31/2-4095	
7/16"	M11	0.323"	0.242"		19/1-4111	31/2-4111	
1/2"	M12, M12.5	0.367"	0.275"		19/1-4127	31/2-4127	48/3-4127
9/16"	M14	0.429"	0.322"		19/1-4142	31/2-4142	48/3-4142
5/8"	M16	0.480"	0.360"			31/2-4158	48/3-4158
11/16"	M18	0.542"	0.406"			31/2-4174	48/3-4174
3/4"		0.590"	0.442"			31/2-4190	48/3-4190
13/16"	M20	0.652"	0.489"			31/2-4206	48/3-4206
7/8"	M22	0.697"	0.523"			31/2-4222	48/3-4222
15/16"	M24	0.760"	0.570"				48/3-4238
1"	M25	0.800"	0.600"				48/3-4254
1 1/8, 1 1/16"	M27	0.896"	0.672"				48/3-4286
1 1/4, 1 3/16"	M30	1.021"	0.766"				48/3-4317
1 3/8, 1 5/16"	M33	1.108"	0.831"				48/3-4349
1/8" NPT		0.437"	0.328"		19/1 - 4097		
1/4" NPT		0.562"	0.421"			31/2-4131C	
3/8" NPT		0.700"	0.531"			31/2-4166C	48/3-4166C
1/2" NPT		0.687"	0.515"			31/2-4209C	48/3-4209C
3/4" NPT		0.906"	0.678"				48/3-4264C
1" NPT		1.125"	0.843"				48/3-4332C

ANSI Rigid Tap Collets



- Change worn taps in seconds
- Quick-Change Style

Dimensions	A	B	C	D	E
Size 1	.75"	.85"	.28"	1.18"	.39"
Size 2	1.22"	1.38"	.43"	1.81"	.75"
Size 3	1.89"	2.19"	.55"	2.68"	1.18"
Size 4	2.36"	2.48"	1.65"	3.27"	1.14"

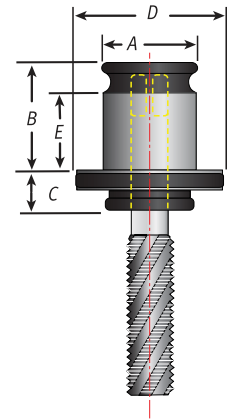

Collet Sets

Part No.	Description
19/11-SET	Size 1, 11 piece set – 0-6" thru 9/16" & 1/8" NPT
31/13-SET	Size 2, 16 piece set – 5/16" thru 1/2" NPT
48/13-SET	Size 3, 16 piece set – 1/2" thru 1" NPT

ANSI Rigid Tap Collets

ANSI	Metric Tap With ANSI Shank	Shank	SQ	Size 1	Size 2	Size 3	Size 4
0-6"	M1.6-M3.5	0.141"	0.110"	19/11-4036			
8, 5/32"	M4	0.168"	0.131"	19/11-4041			
10, 3/16"	M4.5, M5	0.194"	0.152"	19/11-4048			
12, 7/32"		0.220"	0.165"	19/11-4054			
1/4"	M6, M6.3	0.255"	0.191"	19/11-4063			
5/16"	M7, M8	0.318"	0.238"	19/11-4079	31/12-4079		
3/8"	M10	0.381"	0.286"	19/11-4095	31/12-4095		
7/16"	M11	0.323"	0.242"	19/11-4111	31/12-4111		
1/2"	M12, M12.5	0.367"	0.275"	19/11-4127	31/12-4127	48/13-4127	
9/16"	M14	0.429"	0.322"	19/11-4142	31/12-4142	48/13-4142	
5/8"	M16	0.480"	0.360"		31/12-4158	48/13-4158	
11/16"	M18	0.542"	0.406"		31/12-4174	48/13-4174	
3/4"		0.590"	0.442"		31/12-4190C	48/13-4190	
13/16"	M20	0.652"	0.489"		31/12-4206C	48/13-4206	
7/8"	M22	0.697"	0.523"		31/12-4222C	48/13-4222	
15/16"	M24	0.760"	0.570"			48/13-4238	
1"	M25	0.800"	0.600"			48/13-4254	
1 1/8, 1 1/16"	M27	0.896"	0.672"			48/13-4286	
1 1/4, 1 3/16"	M30	1.021"	0.766"			48/13-4317	
1 3/8, 1 5/16"	M33	1.108"	0.831"			48/13-4349	
1 1/2, 1 7/16"	M36	1.233"	0.925"				60/14-4381C
1 5/8"	M39	1.305"	0.925"				60/14-4412C
1 3/4"	M42	1.430"	1.072"				60/14-4444C
1 7/8"		1.520"	1.139"				60/14-4476C
1/8" NPT		0.437"	0.328"	19/11-4097			
1/4" NPT		0.562"	0.421"		31/12-4131C		
3/8" NPT		0.700"	0.531"		31/12-4166C	48/13-4166C	
1/2" NPT		0.687"	0.515"		31/12-4209C	48/13-4209C	
3/4" NPT		0.906"	0.678"			48/13-4264C	
1" NPT		1.125"	0.843"			48/13-4332C	

Tightening Torque Specifications Chart

Recommended Collet & Retention Knob Tightening Torque

Collet	Nut Type	Collets I.D. OVER 1/16" (2mm)	Collets I.D. UNDER 1/16" (2mm)	Order Torque Wrench Adapter
ER16	slotted	42 ft/lbs	30 ft/lbs	04580-16
ER16	hex	42 ft/lbs	30 ft/lbs	04601-16
ER20	slotted	59 ft/lbs	24 ft/lbs	04580-20
ER20	hex	59 ft/lbs	24 ft/lbs	04602-20
ER25	slotted	77 ft/lbs	77 ft/lbs	04503-25
ER25	mini nut	25 ft/lbs	25 ft/lbs	04587
ER32	slotted	100 ft/lbs	100 ft/lbs	04604-32
ER40	slotted	130 ft/lbs	130 ft/lbs	04605-40
SYOZ 25	hook	90 ft/lbs	90 ft/lbs	03690-25
TG 75	slotted	90 ft/lbs	90 ft/lbs	04604-32
TG 100	hook	90 ft/lbs	90 ft/lbs	03690-25

Retention Knobs	Wrench Flats	Drive	Torque	Order Socket
BT30 Taper	0.535"	1/4"	36 ft/lbs	PSS-30BT
ISO 30 Taper	0.535"	3/8"	36 ft/lbs	PSS-30ISO
Any 40 Taper	0.750"	3/8"	76 ft/lbs	PSS-40
BT50 Taper	1.187"	1/2"	99 ft/lbs	PSC-50
CAT50 Taper	1.250"	1/2"	99 ft/lbs	PSC-50

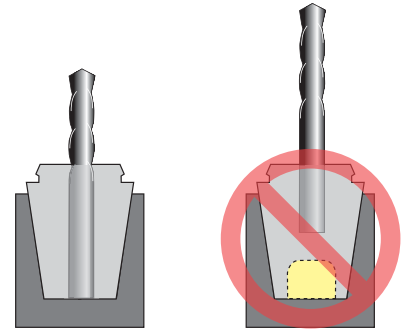

For maximum holding power fill the collet all the way with the tool shank (left) and use a PowerCOAT nut.

DIRECTIONS

1. Snap collet into nut.
2. Insert cutting tool into collet. Make sure shank extends to the bottom of the collet.
3. Hand tighten collet nut assembly into toolholder.
4. Insert toolholder assembly into tightening fixture and secure it.
5. Tighten collet nut to recommended torque using a torque wrench and adapter.

Pinzbohr High Precision Boring Tools



BohrSTAR
Boring Kits



Rough and Finish
Boring Heads



Boring Head
Toolholders



Carbide and HSS
Boring Bars

Built for Speed.

Pinzbohr Modular Boring System

BohrSTAR High Precision Kits

Add a Boring Kit to Your Tooling Arsenal! Range available up to 8.27"

- Range 0.314" up to 8.27" (8mm to 210mm)
- AccuSET graduated dial allows operators to quickly set the head to any cutting diameter in 0.0001" increments
- Triangular and rhombic insert kits available



BohrSTAR 170
Kit Components

BohrSTAR kits are designed for maximum performance and ease-of-use (no spacers or complicated set-ups).

Our boring tools out-perform all others when it comes to accuracy, rigidity, and repeatability.

BohrSTAR components are manufactured from nickle-chrome alloy steel hardened to 58-60 HRC. All moving parts are precision ground for accuracy, wear resistance, and smooth adjustment.



3 kits to choose from

BohrSTAR High Precision Kits

BohrSTAR boring kits include quality, reliability, and ease-of-use features that make setup and adjustment a snap.

BohrSTAR Kit Features

AccuSET Adjustment Dial



Adjustable in 0.0001" increments

Adjustment is This Easy

- AccuSET design for fast and easy cutting adjustments.
- .0001" graduated dial allows operators to quickly set the head to any cutting diameter.

Modular Coupling System

Allows heads to be changed without removing tools from the spindle. Two offset center lock screws apply maximum tightening force between the boring head and the toolholder. This increases rigidity and enhances vibration dampening characteristics.

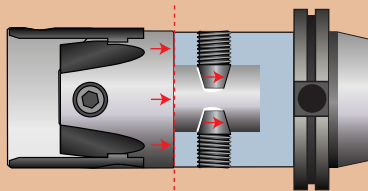

Offset Center Lock Screws

BohrSTAR kits are fully compatible with our 54mm extensions, reducers, and toolholders.



Setup Examples BohrSTAR 210 Kit



Pinzbohr Modular Boring System

BohrSTAR 100 Triangular Kit – Range: 0.314" to 3.94"



Kit Includes Triangular Inserts:

- 2 Pcs. TCMT 06T1
- 3 Pcs. TCMT 0902
- 2 Pcs. TCMT 16T3



TCMT

BohrSTAR kits are designed for maximum performance and ease-of-use (no spacers or complicated set-ups). Our boring tools out perform all others when it comes to accuracy, rigidity, and repeatability.

Our exclusive, modular coupling system features two, tapered locking screws that provide maximum rigidity between the boring head and the toolholder to increase accuracy. All connections are easily made using the tools provided.

Kit Part No.	Description	Range
6991235	BS-54-KIT-RC-8-100	0.314" – 3.94"

BohrSTAR 100 Kit Includes These Components

	Part No.	Description	Length	Height
1	6951234	BS-54-16-W head	.2560"	-
	6943333	BS-06-16-T01 6mm bar	.984"	-
	6943334	BS-08-16-T01 8mm bar	1.378"	-
2	6943335	BS-10-16-T02 10mm bar	1.772"	-
	6943336	BS-12-16-T02 12mm bar	2.244"	-
	6943337	BS-16-16-T02 16mm bar	2.874"	-
	6943338	BS-34-16-T04 34mm bar	3.228"	-
3	6922243	BS-2CT-T04 cartridge	51mm	.71"
	6921239	BS-16-M10 location sleeve	-	-
4	6962233	H3 hex	-	-
	6962235	H5 hex	-	-
	6962236	H6 hex	-	-
	6962238	H8 hex	-	-
5	6972236	T6 torx	-	-
	6972237	T7 torx	-	-
	6972215	T15 torx	-	-
6	6921241	CS-10-25 cartridge screw	-	-

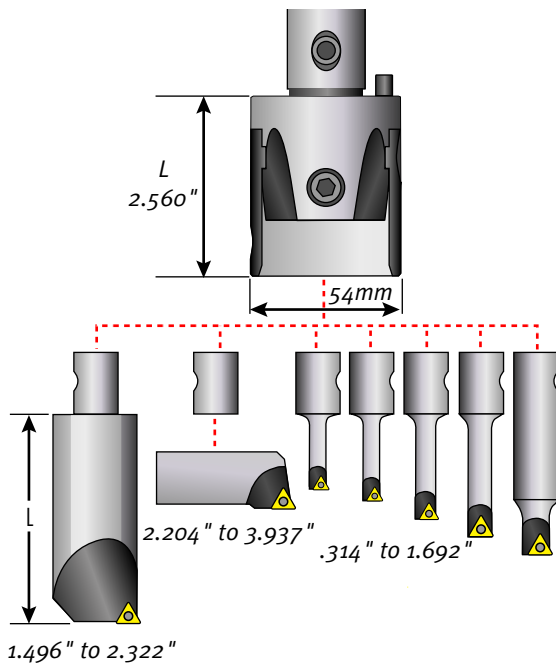

Kit Boring Bar and Insert Specifications

Part No.	Boring Bar Description	Bore Range		L	Insert	Insert Screw	Wrench
		Min	Max				
6943333	BS-06-16-T01	.314"	1.181"	.984"	TCMT 06T1_ _	6811220	T6
6943334	BS-08-16-T01	.394"	1.260"	1.378"	TCMT 06T1_ _	6811235	T6
6943335	BS-10-16-T02	.512"	1.378"	1.772"	TCMT 0902_ _	6811250	T7
6943336	BS-12-16-T02	.630"	1.496"	2.244"	TCMT 0902_ _	6811250	T7
6943337	BS-16-16-T02	.787"	1.692"	2.874"	TCMT 0902_ _	6811260	T7
6943338	BS-34-16-T04	1.496"	2.322"	3.228"	TCMT 16T3_ _	6811260	T15

BohrSTAR 170 Rhombic Kit – Range: 0.314" to 6.69"

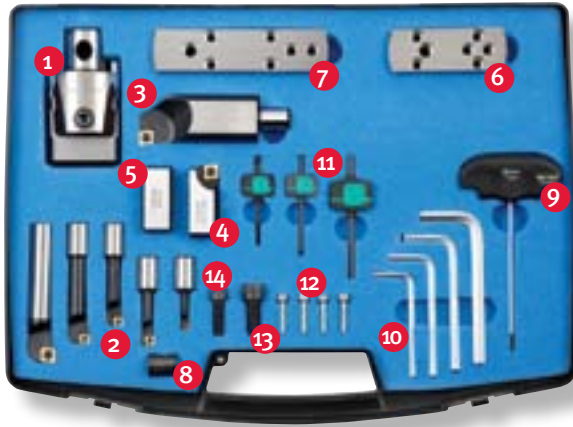

Kit Includes Rhombic Inserts:

- 1 Pc. EPMT 0502
- 3 Pcs. CCMT 0602
- 3 Pcs. CCMT 09T3



See page 151 to order toolholders.

Kit Part No.	Description	Range
6991230	BS-54-KIT-RC-8-170	0.314" – 6.69"

BohrSTAR 170 Kit Includes These Components

Part No.	Description	Length	Height
1	6951234 BS-54-16-W head	2.560"	-
2	6942234 BS-06-16-R02 6mm bar	.984"	-
	6942235 BS-08-16-R03 8mm bar	1.378"	-
	6942236 BS-10-16-R03 10mm bar	1.772"	-
	6942237 BS-12-16-R03 12mm bar	2.244"	-
3	6942238 BS-16-16-R04 16mm bar	2.874"	-
	6942239 BS-34-16-R04 34mm bar	3.228"	-
4	6921234 BS-2CT-R04 cartridge	51mm	.79"
5	6921235 BS-2CW counterweight	47mm	.73"
6	6921236 BS-SP-85-130 small plate	81mm	.79"
7	6921237 BS-SP-125-170 medium plate	121mm	.79"
8	6921239 BS-16-M10 location sleeve	-	-

Part No.	Description
9	6921243 A3 adjusting key
10	6962234 H4 hex
	6962235 H5 hex
	6962236 H6 hex
	6962238 H8 hex
11	6972237 T7 torx
	6972238 T8 torx
	6972215 T15 torx
12	6921240 D-27-21 plate fixing screws
13	6921241 CS-10-25 cartridge screw
14	6921242 CS-08-25 counterweight screw

Kit Boring Bar and Insert Specifications

Part No.	Description	Bore Range			Insert	Insert Screw	Wrench
		Min	Max	L			
6942234	BS-06-16-R02	.314"	1.181"	.984"	EPMT 0502_ _	6811220	T7
6942235	BS-08-16-R03	.394"	1.260"	1.378"	CCMT 0602_ _	6811235	T8
6942236	BS-10-16-R03	.512"	1.378"	1.772"	CCMT 0602_ _	6811250	T8
6942237	BS-12-16-R03	.630"	1.496"	2.244"	CCMT 0602_ _	6811250	T8
6942238	BS-16-16-R04	.787"	1.692"	2.874"	CCMT 09T3_ _	6811260	T15
6942239	BS-34-16-R04	1.496"	2.322"	3.228"	CCMT 09T3_ _	6811260	T15

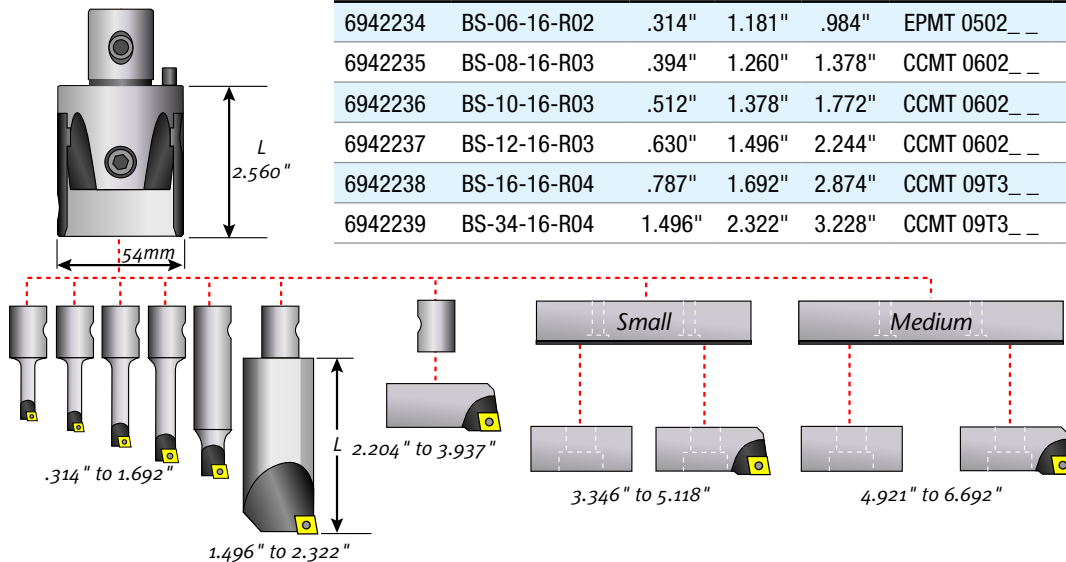

BohrSTAR 210 Triangular Kit – Range: 0.314" to 8.27"

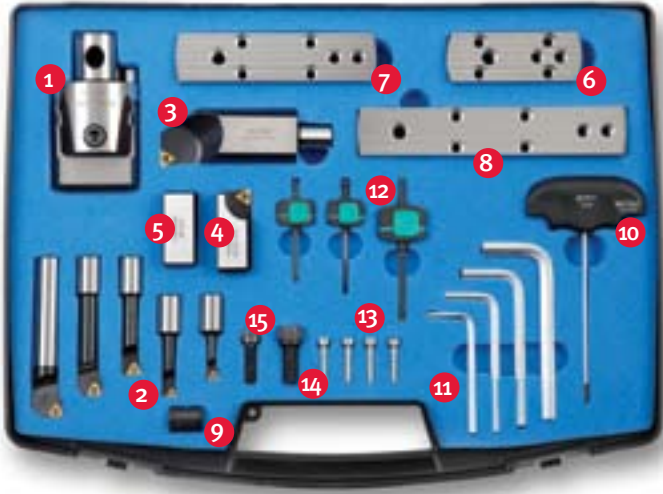

Kit Includes Triangular Inserts:

- 2 Pcs. TCMT 06T1
- 3 Pcs. TCMT 0902
- 2 Pcs. TCMT 16T3



TCMT

BohrSTAR kits are designed for maximum performance and ease-of-use (no spacers or complicated set-ups). Our boring tools out perform all others when it comes to accuracy, rigidity, and repeatability.

BohrSTAR 210 Kit Includes These Components

Part No.	Description	Length	Height
1	6951234 BS-54-16-W head	2.560"	-
2	6943333 BS-06-16-T01 6mm bar	.984"	-
	6943334 BS-08-16-T01 8mm bar	1.378"	-
	6943335 BS-10-16-T02 10mm bar	1.772"	-
	6943336 BS-12-16-T02 12mm bar	2.244"	-
3	6943337 BS-16-16-T02 16mm bar	2.874"	-
	6943338 BS-34-16-T04 34mm bar	3.228"	-
4	6922243 BS-2CT-T04 cartridge	51mm	.79"
5	6921235 BS-2CW counterweight	47mm	.73"
6	6921236 BS-SP-85-130 small plate	81mm	.79"
7	6921237 BS-SP-125-170 medium plate	121mm	.79"
8	6921238 BS-SP-165-210 large plate	161mm	.79"

Kit Part No.	Description	Range
6991240	BS-54-KIT-RC-8-210	0.314" – 8.27"

Part No.	Description
9	6921239 BS-16-M10 location sleeve
10	6921243 A3 adjusting key
11	6962234 H4 hex
	6962235 H5 hex
	6962236 H6 hex
	6962238 H8 hex
12	6972236 T6 torx
	6972237 T7 torx
	6972215 T15 torx
13	6921240 D-27-21 plate fixing screws
14	6921241 CS-10-25 cartridge screw
15	6921242 CS-08-25 counterweight screw

Kit Boring Bar and Insert Specifications

Part No.	Description	Bore Range		L	Insert	Insert Screw	Wrench
		Min	Max				
6943333	BS-06-16-T01	.314"	1.181"	.984"	TCMT 06T1__	6811220	T6
6943334	BS-08-16-T01	.394"	1.260"	1.378"	TCMT 06T1__	6811235	T6
6943335	BS-10-16-T02	.512"	1.378"	1.772"	TCMT 0902__	6811250	T7
6943336	BS-12-16-T02	.630"	1.496"	2.244"	TCMT 0902__	6811250	T7
6943337	BS-16-16-T02	.787"	1.692"	2.874"	TCMT 0902__	6811260	T7
6943338	BS-34-16-T04	1.496"	2.322"	3.228"	TCMT 16T3__	6811260	T15

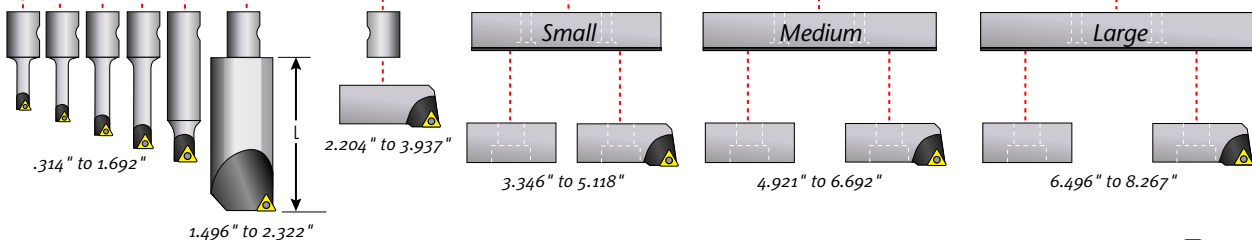
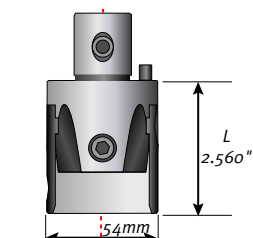

High Precision Toolholders for BohrSTAR Kits



- CAT40, CAT50, BT40, BT50, HSK63A, HSK100A, Weldon, and R8
- Compatible with our 54mm boring heads, adapters, and reducers
- Exceed industry standards for taper accuracy and concentricity

Modular Coupling System

Offset Center Lock Screws

Our exclusive, modular coupling system features two, tapered locking screws that provide maximum rigidity between the boring head and the toolholder to increase accuracy.

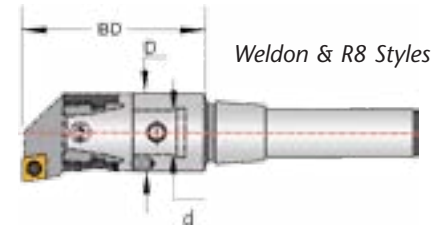
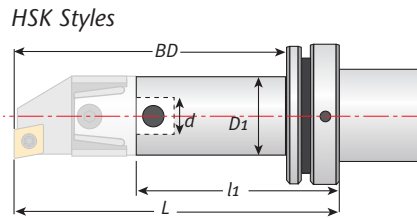
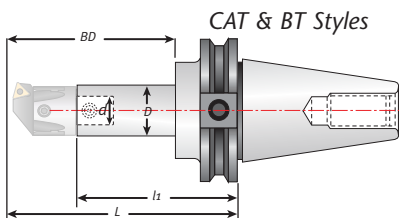
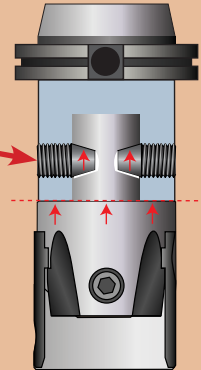

Use the drawings to select your toolholder size.

Toolholders for BohrSTAR Kits

Part No.	Description	D (mm)	d (mm)	BD	L	l1	Coupling Screw
6134310	CT-340-54-120	54	28	4.724"	5.60"	3.00"	6811550
6134315	CT-340-54-160	54	28	6.299"	7.17"	4.57"	6811550
6134320	CT-340-54-200	54	28	7.874"	8.74"	6.14"	6811550
6141305	CT-350-54-90	54	28	3.543"	5.04"	2.44"	6811550
6141310	CT-350-54-160	54	28	6.299"	7.80"	5.20"	6811550
6141315	CT-350-54-200	54	28	7.874"	9.37"	6.77"	6811550
6140400	BT-340-54-90	54	28	3.543"	4.72"	2.13"	6811550
6140425	BT-340-54-160	54	28	6.299"	7.48"	4.88"	6811550
6140450	BT-340-54-200	54	28	7.874"	9.06"	6.46"	6811550
6150375	BT-350-54-90	54	28	3.543"	5.16"	2.56"	6811550
6150400	BT-350-54-160	54	28	6.299"	7.91"	5.31"	6811550
6150425	BT-350-54-200	54	28	7.874"	9.49"	6.90"	6811550
6155635	HSK-63A-54-110	54	28	4.331"	5.35"	2.76"	6811550
6155105	HSK-100A-54-110	54	28	4.331"	5.47"	2.76"	6811550
6165343	B-20-54-110-3/4	54	12	4.331"			6811550
6165103	B-25-54-110-1.0	54	15	4.331"			6811550
6165144	B-32-54-110-1-1/4	54	24	4.331"			6811550
6165123	B-40-54-110-1-1/2	54	24	4.331"			6811550
6165805	R8-54-110	54	28	4.331"			6811550

Pinzbohr High Precision Modular Boring Tools

Pinzbohr Modular System



Pinzbohr is a flexible boring system for holes ranging from 0.315" up to 19.685". The system includes all necessary extensions and reducers, rough heads, finish heads and even includes face mill arbors and end mill holder options.

Coupling System

Our exclusive, modular coupling system features two, tapered locking screws that provide maximum rigidity between the boring head and the toolholder. All connections are easily made using the tools provided.



Boring Heads

Carbide & HSS Boring Bars



Toolholders



Extensions & Reducers



modular toolholders

Pinzbohr Modular Boring Tools – Range .315" – 19.685"

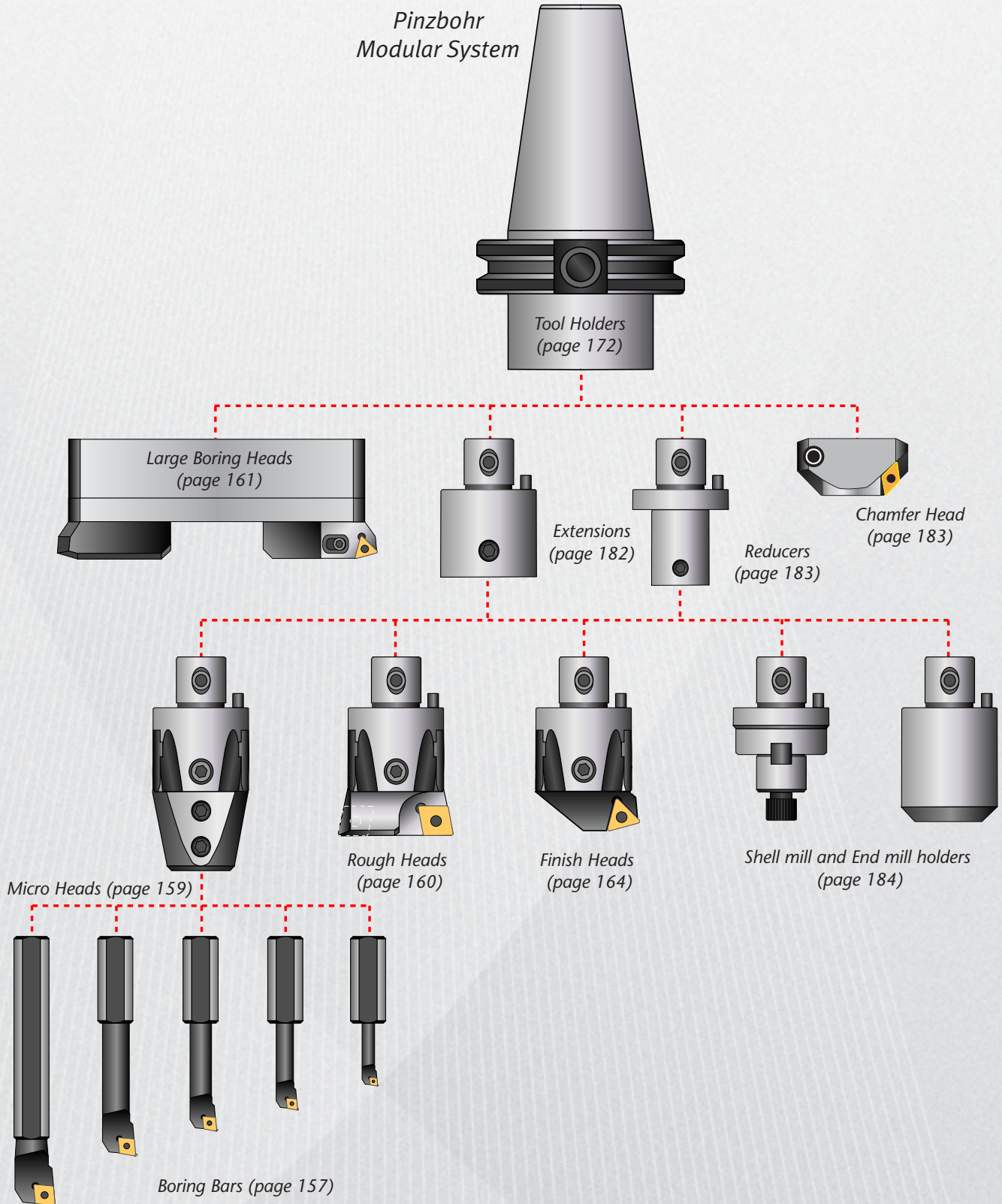

Pinzbohr Design Features Are Unbeatable

Pinzbohr Design

Pinzbohr is More Rigid and Accurate Than Other Manufacturers' Designs

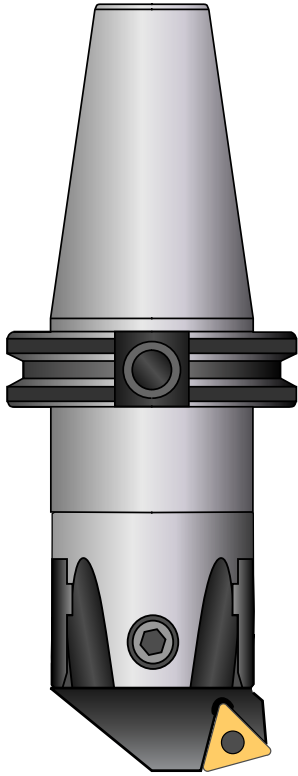

- Simple and extremely strong design for best reliability, rigidity, and repeatability.
- Flexible, modular system reduces tooling inventory.
- Top quality steel alloy hardened to 58-60 HRC.
- Heads are heat treated to minimize wear.
- Precision ground components for highest accuracy.

All Pinzbohr heads feature insert pockets that are either integral with the body of the head, or integral cartridges to provide maximum rigidity and accuracy.

Other Manufacturers' Designs

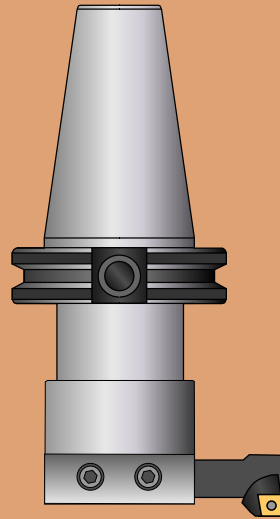

Design #1

Dogleg design relies on an extension out from the body of the head to maintain accuracy.

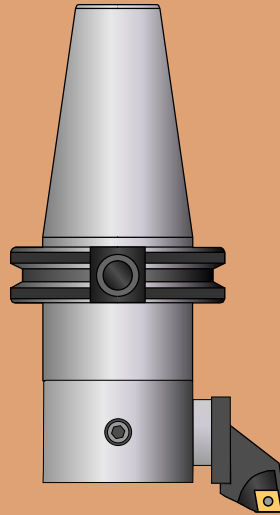

Design #2

Dogleg variation also extends beyond the body of the boring head.

Modular Coupling System

Allows heads to be changed without removing tools from the spindle. Two offset center lock screws apply maximum tightening force between the boring head and the toolholder. This increases rigidity and enhances vibration dampening characteristics.

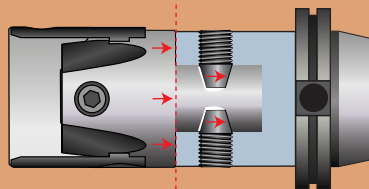

Offset Center Lock Screws

Ease-of-Use Features

- SafetySET feature prevents damage to the adjustment screw.

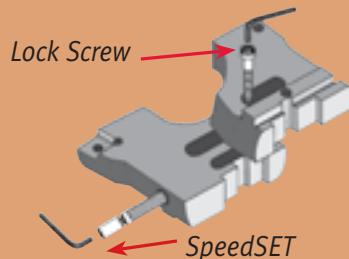

- SpeedSET synchronized adjustment for setting of roughing heads.

Adjustment is This Easy

- AccuSET design for fast and easy cutting adjustments.

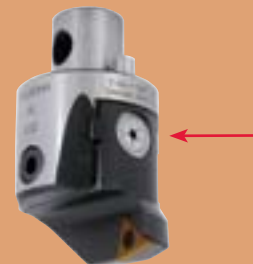

- .0001" graduated dial allows operators to quickly set the head to any cutting diameter.

Choosing a Pinzbohr Boring Head

Choosing a Boring Head

Use a 75-degree head for thru holes when the hole position is accurate. A 75-degree head will tend to follow a pre-existing hole. A 75-degree head can also be used when there is a lot of stock to be removed. The lead angle will allow higher feed rates.

Use a 90-degree boring head when a hole is off-center, shifted, or off-angle. The 90-degree lead angle will have fewer tendencies to follow the existing hole. It is also used for blind or stepped holes and is the most versatile of our heads.

The diameter of the boring bar should always be less than the diameter of the pre-existing hole to allow proper chip evacuation.

5:1 length-to-diameter ratios can be achieved when roughing with steel bars.

3:1 length-to-diameter ratios can be achieved when finishing with steel bars. 7:1

length-to-diameter ratios can be achieved with carbide bars.

Three Major Influences on Boring

1. Depth of Cut (D.O.C.)

To determine the depth of a cut, take the finish diameter, minus the starting diameter and divide by two (2). The D.O.C. should always be greater than or equal to the nose radius of the insert. This will produce a stable cut with axial cutting forces. When D.O.C. is less than the radius, the forces are radial, and can cause chatter and deflection.

2. Feed Rate (IPR)

Feeds and speeds are always dependent upon material, machine, setup conditions (fixturing) and tool over-hang. The feed rate (IPR) should always be larger than the hone of the insert and at least 25% of the nose radius. This creates full use of the chip breaker. An IPR less than the hone will produce vibration, which will affect the tool life and finish.

3. Speed (SFPM)

Speed is the function of coating, nose radius, and over-hang. Higher speeds typically produce a better finish, shorter cycling times and better chip evacuation. Lower speed reduces the possibility of chatter, but also has higher cycle times and poorer quality finishes. This can also cause a built-up edge and reduce insert life. Sometimes coatings can be used to run higher surface footage, create better finish, and limit built-up edges.



75° Lead Angle Rough Head

90° Lead Angle Rough Head

Carbide or HSS Boring Bars

Use Micro Heads with Boring Bars

Pinzbohr Boring Tool Selection Guide

Use the questions below to determine your tooling requirements. You can also fill out and fax this information to us if you need assistance with your tooling selection. Fax it to: (317) 803-8001.

Name _____

Company _____

Address _____

City _____ St _____ Zip _____

E-mail _____ Ph _____ Fax _____

1. What is the finish size of the hole? _____

(Determines size of boring head.)

2. What is the tolerance of the finished hole? _____

(Determines if you need rough or finish boring head.)

3. Is the starting hole forged, cast, drilled, or reamed? _____

(Determines whether you need 75 or 90 degree boring head.)

4. What is the design of the bored hole? _____

(Also determines degree of boring head.)

a. Stepped bore _____

b. Thru bore _____

5. What material are you machining? _____

(Determines insert grade and chip breaker selection.)

6. What spindle type is on the machine? _____

(Determines holder selection.)

7. How deep is the bore? _____

(Determines length of holder and extensions.)

8. Do you require any extra reach for fixturing or other reasons? _____

9. Does your machine have coolant-thru capability? _____

Misc: Select coolant option based on connection diameter and bore depth requirements (question #6 above).



Key to boring head descriptions

A 22 75 400 A = finish heads, D = rough heads (see #2 above)

22 = connection diameter (see question #1 above)

75 = approach angle (see question #3 above)

400 = insert style or CT cartridge (see question #5 above)

Key to boring toolholder descriptions

CT 330 or 350 22 100

CT = type of spindle (see question #6 above)

330 = taper size (see question #6 above)

22 = connection diameter (match head connection)

100 = boring depth (BD) (see question #7 above)

HSS Boring Bars – Use With Micro Head A-42-016



Features

- 16mm shanks for A-42-016 micro head
- Precision ground accuracy



Inserts and Cartridges
pg. 168



Toolholders
pg. 172



Extensions & Reducers
pg. 182



Retention Knobs
pg. 200

5:1 length-to-diameter ratios can be achieved when roughing with steel bars. 3:1 length-to-diameter ratios can be achieved when finishing with steel bars.

The shortest bar overhang possible should be used to maximize results.

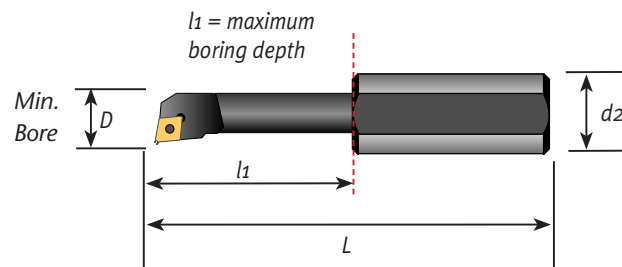

HSS Boring Bars for Micro Head A-42-016

Part No.	Description	Min. Bore	d2 (mm)	L	Max Depth (l1)	Insert	Screw	Wrench
6711225	S06-16SEXPR-04	.315"	16	2.756"	.945"	EPGT 0401__L	6811210	T6
6711235	S06-16SEXPR-05	.315"	16	2.756"	1.260"	EPMT 0502__	6811220	T6
6722225	S06-16STFCR-06	.315"	16	2.756"	1.260"	TCMT 06T1__	6811215	T6
6711245	S08-16SCLCR-06	.394"	16	3.150"	1.575"	CCMT 0602__	6811235	T7
6722235	S08-16STFCR-06	.394"	16	3.150"	1.575"	TCMT 06T1__	6811215	T6
6711255	S10-16SCLCR-06	.512"	16	3.543"	2.047"	CCMT 0602__	6811250	T7
6722245	S10-16STFCR-09	.512"	16	3.543"	2.047"	TCMT 0902__	6811230	T7
6711265	S12-16SCLCR-06	.630"	16	3.937"	2.520"	CCMT 0602__	6811255	T7
6722255	S12-16STFCR-09	.630"	16	3.937"	2.520"	TCMT 0902__	6811230	T7
6711275	S16-16SCLCR-09	.787"	16	4.331"	3.150"	CCMT 09T3__	6811260	T15
6722265	S16-16STFCR-09	.787"	16	4.331"	3.150"	TCMT 0902__	6811230	T7
6722275	S16-16STFCR-16	.787"	16	4.331"	3.150"	TCMT 16T3__	6811260	T15

Boring Bars – Carbide or HSS Shank



Features

- Minimum bore .315"
- Maximum bore 1.496"
- Carbide or HSS

Usage

- 7:1 length-to-diameter ratios can be achieved with carbide bars
- 5:1 for roughing with steel bars
- 3:1 for finishing with steel bars

Select a boring bar with a "d2" dimension that matches the "d2" of the head.

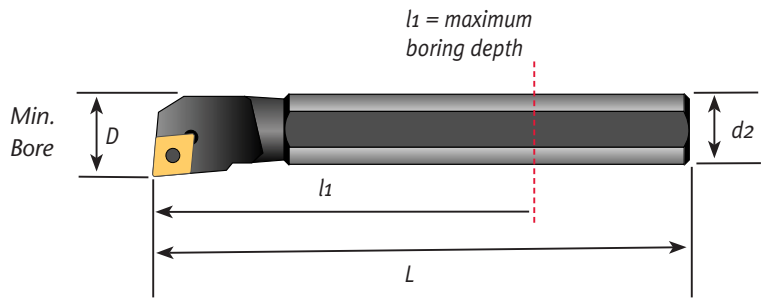

Carbide Shank Boring Bars

Part No.	Description	Micro Head	Min. Bore	d2	L	Max Depth	Insert	Screw	Wrench
6733225	C06F-SEXPR-04	A-27-006	.315"	6mm	3.150"	1.654"	EPGT0401__L	6811210	T6
6733230	C06-08H-SELPR-05	A-27-008 or A-32-008	.315"	8mm	3.150"	1.654"	EMPT0502__	6811210	T6
6733235	C08G-SCLCR-06	A-27-008 or A-32-008	.394"	8mm	3.543"	2.205"	CCMT0602__	6811235	T7
6733245	C10J-SCLCR-06	A-32-010 or A-42-010	.512"	10mm	4.331"	2.756"	CCMT0602__	6811250	T7
6733255	C12K-SCLCR-06	A-42-012	.630"	12mm	4.921"	3.307"	CCMT0602__	6811255	T7
6733265	C16L-SCLCR-09	A-42-016	.787"	16mm	5.512"	4.409"	CCMT09T3__	6811260	T15

HSS Shank Boring Bars

Part No.	Description	Micro Head	Min. Bore	d2	L	Max Depth	Insert	Screw	Wrench
6733227	S06E-SEXPR-04	A-27-006	.315"	6mm	2.756"	1.181"	EPGT0401__L	6811210	T6
6733232	S06D-SELP-05	A-27-006	.315"	6mm	2.362"	1.181"	EMPT0502__	6811210	T6
6733237	S08F-SCLCR-06	A-27-008 & A32-008	.394"	8mm	3.150"	1.575"	CCMT0602__	6811235	T7
6733247	S10G-SCLCR-06	A-32-010 & A42-010	.512"	10mm	3.543"	1.969"	CCMT0602__	6811250	T7
6733257	S12H-SCLCR-06	A-42-012	.630"	12mm	3.937"	2.362"	CCMT0602__	6811255	T7
6733267	S16J-SCLCR-09	A-42-016	.787"	16mm	4.331"	3.150"	CCMT09T3__	6811260	T15

Micro Heads for Carbide or HSS Boring Bars



Features

- .0001" dial allows fast and easy adjustments
- Tapered nose improves clearance
- Two offset center lock screws maximize rigidity while still permitting fast tool changes



Inserts and Cartridges
pg. 168



Toolholders
pg. 172



Extensions & Reducers
pg. 182



Retention Knobs
pg. 200

Micro Heads available in 5 shank sizes for carbide and HSS boring bars.

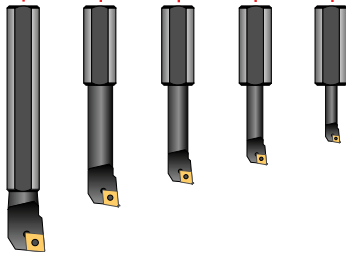

Adjustment Is This Easy



Adjustable in 0.0001" increments

Metric dials available

.0001" dial allows operators to quickly set the finish head to any diameter.

Procedure:

1. Loosen locking screw
2. Remove any backlash
3. Rotate scale to desired setting
4. Tighten locking screw

Select a micro head with a "d2" dimension that matches the "d2" of the boring bar.

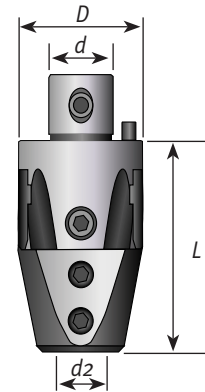

AccuSET Micro Heads

Part No.	Description	Range		D (mm)	d (mm)	d2 (mm)	L
		Min	Max				
6011000	A-27-006	.315"	.787"	27	15	6	1.97"
6011050	A-27-008	.394"	.827"	27	15	8	1.97"
6011100	A-32-008	.394"	.827"	32	18	8	2.28"
6011150	A-32-010	.512"	.984"	32	18	10	2.28"
6011200	A-42-010	.512"	1.142"	42	24	10	2.76"
6011250	A-42-012	.63"	1.339"	42	24	12	2.76"
6011300	A-42-016	.787"	1.496"	42	24	16	2.76"

Note: All wrenches are included with each boring head. No special tools are needed.

75° Lead Angle Rough Heads – Range .945" up to 8.661"



Integral pocket type

Features

- SpeedSET feature adjusts both slides at once and slides won't lose position during adjustment
- SafetySET feature prevents accidental damage to adjustment screw
- Two insert pockets for faster cutting and better accuracy

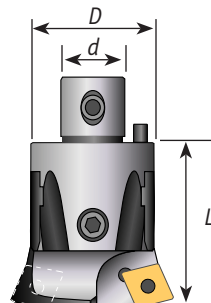

Cartridge type rough head

75° Integral Pocket Rough Heads

Part No.	Description	Range		(mm)		L	Insert	Screw
		Min	Max	D	d			
6275100	D-22-75-400	.945"	1.181"	22	12	1.39"	CCMT 0602_	6811250
6275105	D-27-75-409	1.142"	1.575"	27	15	1.65"	CCMT 09T3_	6811260
6275115	D-32-75-409	1.535"	1.969"	32	18	1.77"	CCMT 09T3_	6811260
6275120	D-42-75-300	1.929"	2.559"	42	24	2.20"	TCMT 09T3_	6811262
6275125	D-42-75-402	1.929"	2.559"	42	24	2.20"	CCMT 1204_	6811266
6275130	D-42-75-402N	2.283"	2.559"	42	24	2.20"	CNMG 1204_	6811270
6275135	D-54-75-300	2.48"	3.228"	54	28	2.60"	TCMT 09T3_	6811262
6275140	D-54-75-402	2.48"	3.228"	54	28	2.60"	CCMT 1204_	6811 266
6275145	D-54-75-402N	2.48"	3.228"	54	28	2.60"	CNMG 1204_	6811270

75° Cartridge Type Rough Heads

Part No.	Description	Range		Cartridge	D (mm)	d (mm)	L	Insert	Screw
		Min	Max						
6275150	D-68-75-2CT-300	3.15"	4.016"	2CT-75-300	68	36	3.39"	TCMT 09T3_	6811262
6275155	D-68-75-2CT-402	3.15"	4.016"	2CT-75-402	68	36	3.39"	CCMT 1204_	6811266
6275160	D-68-75-2CT-402N	3.15"	4.016"	2CT-75-402N	68	36	3.39"	CNMG 1204_	6811270
6275165	D-85-75-3CT-300	3.937"	4.921"	3CT-75-300	85	50	3.94"	TCMT 16T3_	6811262
6275170	D-85-75-3CT-402	3.937"	4.921"	3CT-75-402	85	50	3.94"	CCMT 1204_	6811266
6275175	D-85-75-3CT-402N	3.937"	4.921"	3CT-75-402N	85	50	3.94"	CNMG 1204_	6811270
6275180	D-100-75-3CT-300	4.921"	6.299"	3CT-75-300	110	60	3.94"	TCMT 16T3_	6811262
6275185	D-100-75-3CT-402	4.921"	6.299"	3CT-75-402	110	60	3.94"	CCMT 1204_	6811266
6275190	D-100-75-3CT-402N	4.921"	6.299"	3CT-75-402N	110	60	3.94"	CNMG 1204_	6811270
6275195	D-200-75-3CT-300	6.299"	8.661"	2CT-75-300	145	60	3.94"	TCMT 16T3_	6811262
6275200	D-200-75-3CT-402	6.299"	8.661"	3CT-75-402	145	60	3.94"	CCMT 1204_	6811266
6275205	D-200-75-3CT-402N	6.299"	8.661"	3CT-75-402N	145	60	3.94"	CNMG 1204_	6811270

AccuSET dial not available on small rough heads due to their design differences.

75° Lead Angle Rough Heads – Range 8.661" up to 19.685"



Features

- Two AccuSET .0001" dials for setting both inserts independently
- Top quality steel alloy hardened to 58-60 HRC.
- Precision ground components for accuracy.



Inserts and Cartridges
pg. 168



Toolholders
pg. 172



Extensions & Reducers
pg. 182



Retention Knobs
pg. 200

75° lead angle heads tend to self center in the pilot hole, stabilizing the cut and maximizing stock removal rates.



Use large boring heads with direct mount toolholders or ADT 100-50 adapter and a toolholder with a 100mm connection. See page 179.

Adjustment Is This Easy



Adjustable in 0.0001" increments

Metric dials available

.0001" dial allows operators to quickly set the finish head to any diameter.

Procedure:

1. Loosen locking screw
2. Remove any backlash
3. Rotate scale to desired setting
4. Tighten locking screw

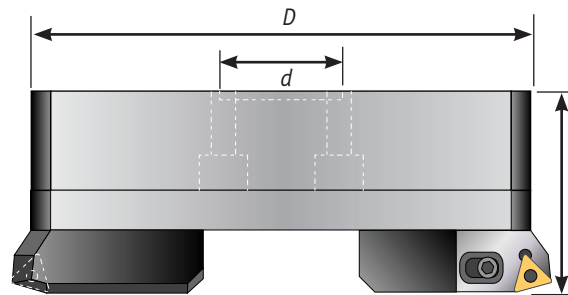

75° Large Rough Heads

Part No.	Description	Range		Cartridge	D (mm)	d (mm)	L	Insert	Screw
		Min	Max						
6275210	D-300-75-3CT-300	8.661"	12.598"	3CT-75-300	202	60	3.54"	TCMT 16T3_	6811262
6275215	D-300-75-3CT-402	8.661"	12.598"	3CT-75-402	202	60	3.54"	CCMT 1204_	6811266
6275220	D-300-75-3CT-402N	8.661"	12.598"	3CT-75-402N	202	60	3.54"	CNMG 1204_	6811270
6275225	D-400-75-3CT-300	11.417"	15.748"	3CT-75-300	272	60	3.54"	TCMT 16T3_	6811262
6275230	D-400-75-3CT-402	11.417"	15.748"	3CT-75-402	272	60	3.54"	CCMT 1204_	6811266
6275235	D-400-75-3CT-402N	11.417"	15.748"	3CT-75-402N	272	60	3.54"	CNMG 1204_	6811270
6275240	D-500-75-3CT-300	14.567"	19.685"	3CT-75-300	352	60	3.54"	TCMT 16T3_	6811262
6275245	D-500-75-3CT-402	14.567"	19.685"	3CT-75-402	352	60	3.54"	CCMT 1204_	6811266
6275250	D-500-75-3CT-402N	14.567"	19.685"	3CT-75-402N	352	60	3.54"	CNMG 1204_	6811270

AccuSET, SafetySET, and SpeedSET features not available on large boring heads due to their design differences.



All Techniks products are backed by our 100% satisfaction guarantee!

90° Lead Angle Rough Heads – Range .945" up to 8.661"



Integral pocket type

Features

- SpeedSET feature adjusts both slides at once and slides won't lose position during adjustment
- SafetySET feature prevents accidental damage to the adjustment screw
- Two insert pockets for faster metal removal

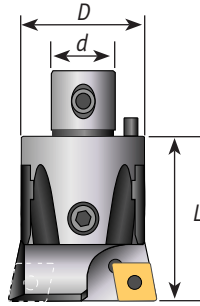

Cartridge type rough head

90° Integral Pocket Type Rough Heads

PART No.	Description	Range		(mm)		L	Insert	Screw
		Min	Max	D	d			
6390100	D-22-90-400	.945"	1.181"	22	12	1.39"	CCMT 0602_	6811250
6390105	D-27-90-409	1.142"	1.575"	27	15	1.65"	CCMT 09T3_	6811260
6390110	D-32-90-409	1.535"	1.969"	32	18	1.77"	CCMT 09T3_	6811260
6390115	D-42-90-300	1.929"	2.559"	42	24	2.20"	TCMT 16T3_	6811262
6390120	D-42-90-402	1.929"	2.559"	42	24	2.20"	CCMT 1204_	6811266
6390125	D-42-90-402N	2.283"	2.559"	42	24	2.20"	CNMG 1204_	6811270
6390130	D-54-90-300	2.48"	3.228"	54	28	2.60"	TCMT 16T3_	6811262
6390135	D-54-90-402	2.48"	3.228"	54	28	2.60"	CCMT 1204_	6811266
6390140	D-54-90-402N	2.48"	3.228"	54	28	2.60"	CNMG 1204_	6811270

90° Cartridge Type Rough Heads

Part No.	Description	Range		Cartridge	D (mm)	d (mm)	L	Insert	Screw
		Min	Max						
6390145	D-68-90-2CT-300	3.15"	4.016"	2CT-90-300	68	36	3.39"	TCMT 16T3_	6811262
6390150	D-68-90-2CT-402	3.15"	4.016"	2CT-90-402	68	36	3.39"	CCMT 1204_	6811266
6390155	D-68-90-2CT-402N	3.15"	4.016"	2CT-90-402N	68	36	3.39"	CNMG 1204_	6811270
6390160	D-85-90-3CT-300	3.937"	4.921"	3CT-90-300	85	50	3.94"	TCMT 16T3_	6811262
6390165	D-85-90-3CT-402	3.937"	4.921"	3CT-90-402	85	50	3.94"	CCMT 1204_	6811266
6390170	D-85-90-3CT-402N	3.937"	4.921"	3CT-90-402N	85	50	3.94"	CNMG 1204_	6811270
6390175	D-100-90-3CT-300	4.921"	6.299"	3CT-90-300	110	60	3.94"	TCMT 16T3_	6811262
6390180	D-100-90-3CT-402	4.921"	6.299"	3CT-90-402	110	60	3.94"	CCMT 1204_	6811266
6390185	D-100-90-3CT-402N	4.921"	6.299"	3CT-90-402N	110	60	3.94"	CNMG 1204_	6811270
6390190	D-200-90-3CT-300	6.299"	8.661"	2CT-90-300	145	60	3.94"	TCMT 16T3_	6811262
6390200	D-200-90-3CT-402	6.299"	8.661"	3CT-90-402	145	60	3.94"	CCMT 1204_	6811266
6390205	D-200-90-3CT-402N	6.299"	8.661"	3CT-90-402N	145	60	3.94"	CNMG 1204_	6811270

AccuSET dial not available on small rough heads due to their design differences.

90° Lead Angle Rough Heads – Range 8.661" up to 19.685"



Features

- Two AccuSET .0001" dials for setting both inserts independently
- Top quality steel alloy hardened to 58-60 HRC.
- Precision ground components for accuracy.



Inserts and Cartridges
pg. 168



Toolholders
pg. 172



Extensions & Reducers
pg. 182



Retention Knobs
pg. 200

Use 90° lead angle heads when performing blind boring, or if the desired hole is not exactly on center with your pilot hole. The 90° lead will have less tendency to follow the pilot hole.

Adjustment Is This Easy



Adjustable in 0.0001" increments

Metric dials available

.0001" dial allows operators to quickly set the finish head to any diameter.

Procedure:

1. Loosen locking screw
2. Remove any backlash
3. Rotate scale to desired setting
4. Tighten locking screw



Use large boring heads with direct mount toolholders or ADT 100-50 adapter and a toolholder with a 100mm connection.
See page 179.

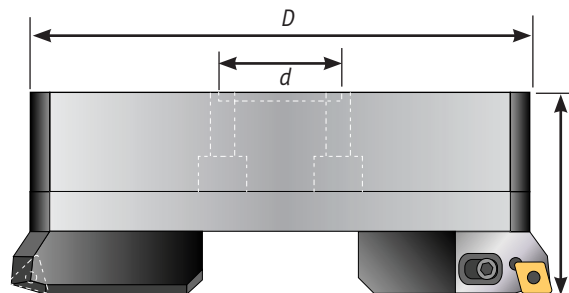

90° Large Rough Heads

Part No.	Description	Range		Cartridge	D (mm)	d (mm)	L	Insert	Screw
		Min	Max						
6390210	D-300-90-3CT-300	8.661"	12.598"	3CT-90-300	202	60	3.54"	TCMT 16T3_	6811262
6390215	D-300-90-3CT-402	8.661"	12.598"	3CT-90-402	202	60	3.54"	CCMT 1204_	6811266
6390220	D-300-90-3CT-402N	8.661"	12.598"	3CT-90-402N	202	60	3.54"	CNMG 1204_	6811270
6390225	D-400-90-3CT-300	11.417"	15.748"	3CT-90-300	272	60	3.54"	TCMT 16T3_	6811262
6390230	D-400-90-3CT-402	11.417"	15.748"	3CT-90-402	272	60	3.54"	CCMT 1204_	6811266
6390235	D-400-90-3CT-402N	11.417"	15.748"	3CT-90-402N	272	60	3.54"	CNMG 1204_	6811270
6390240	D-500-90-3CT-300	14.567"	19.685"	3CT-90-300	352	60	3.54"	TCMT 16T3_	6811262
6390245	D-500-90-3CT-402	14.567"	19.685"	3CT-90-402	352	60	3.54"	CCMT 1204_	6811266
6390250	D-500-90-3CT-402N	14.567"	19.685"	3CT-90-402N	352	60	3.54"	CNMG 1204_	6811270

SafetySET, and SpeedSET features not available on large boring heads due to their design differences.

75° Lead Angle Finish Heads – Range .945" up to 8.661"



Integral pocket type

Features

- AccuSET spring-loaded slide won't lose position during adjustment
- .0001" dial allows fast and easy adjustments
- Designed for maximum rigidity and accuracy

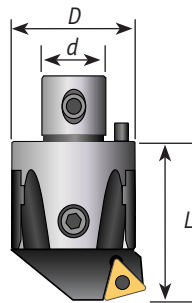

Cartridge type

75° Integral Pocket Type Finish Heads

Part No.	Description	Range		D (mm)	d (mm)	L	Insert	Screw
		Min	Max					
6275255	A-22-75-400	.945"	1.181"	22	12	1.39"	CCMT 0602_	6811250
6275260	A-27-75-409	1.142"	1.575"	27	15	1.65"	CCMT 09T3_	6811260
6275265	A-32-75-409	1.535"	1.969"	32	18	1.77"	CCMT 09T3_	6811260
6275270	A-42-75-300	1.929"	2.559"	42	24	2.20"	TCMT 16T3_	6811262
6275275	A-54-75-300	2.48"	3.228"	54	28	2.60"	TCMT 16T3_	6811262

75° Cartridge Type Finish Heads

Part No.	Description	Range		Cartridge	D (mm)	d (mm)	L	Insert	Screw
		Min	Max						
6275280	A-68-75-2CT-300	3.15"	4.016"	2CT-75-300	68	36	3.39"	TCMT 16T3_	6811262
6275285	A-68-75-2CT-402	3.15"	4.016"	2CT-75-402	68	36	3.39"	CCMT 1204_	6811266
6275290	A-68-75-2CT-402N	3.15"	4.016"	2CT-75-402N	68	36	3.39"	CNMG 1204_	6811270
6275295	A-85-75-3CT-300	3.937"	4.921"	3CT-75-300	85	50	3.94"	TCMT 16T3_	6811262
6275300	A-85-75-3CT-402	3.937"	4.921"	3CT-75-402	85	50	3.94"	CCMT 1204_	6811266
6275305	A-85-75-3CT-402N	3.937"	4.921"	3CT-75-402N	85	50	3.94"	CNMG 1204_	6811270
6275310	A-100-75-3CT-300	4.921"	6.299"	3CT-75-300	110	60	3.94"	TCMT 16T3_	6811262
6275315	A-100-75-3CT-402	4.921"	6.299"	3CT-75-402	110	60	3.94"	CCMT 1204_	6811266
6275320	A-100-75-3CT-402N	4.921"	6.299"	3CT-75-402N	110	60	3.94"	CNMG 1204_	6811270
6275325	A-200-75-3CT-300	6.299"	8.661"	2CT-75-300	145	60	3.94"	TCMT 16T3_	6811262
6275330	A-200-75-3CT-402	6.299"	8.661"	3CT-75-402	145	60	3.94"	CCMT 1204_	6811266
6275335	A-200-75-3CT-402N	6.299"	8.661"	3CT-75-402N	145	60	3.94"	CNMG 1204_	6811270

75° Lead Angle Finish Heads – Range 8.661" up to 19.685"



Features

- AccuSET .0001" adjustment dial
- Designed for maximum rigidity and accuracy
- Top quality steel alloy hardened to 58-60 HRc



Inserts and Cartridges
pg. 168



Toolholders
pg. 172



Extensions & Reducers
pg. 182



Retention Knobs
pg. 200

75° lead angle head tends to self-center in the pilot hole, stabilizing the cut and maximizing stock removal rates.



Use large boring heads with direct mount toolholders or ADT 100-50 adapter and a toolholder with a 100mm connection. See pg. 179

AccuSET Adjustment Dial



Adjustable in 0.0001" increments

Metric dials available

.0001" dial allows operators to quickly set the finish head to any diameter.

Procedure:

1. Loosen locking screw
2. Remove any backlash
3. Rotate scale to desired setting
4. Tighten locking screw

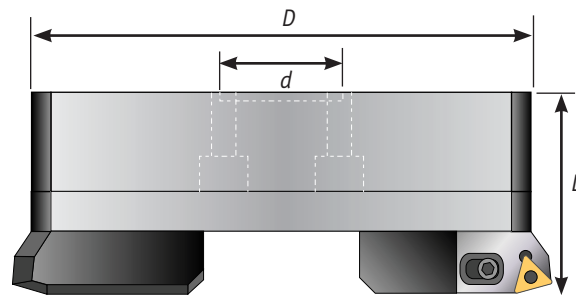

75° Large Finish Heads

Part No.	Description	Range		Cartridge	D (mm)	d (mm)	L	Insert	Screw
		Min	Max						
6275340	A-300-75-3CT-300	8.661"	12.598"	3CT.75.300	202	60	3.54"	TCMT 16T3_	6811262
6275345	A-300-75-3CT-402	8.661"	12.598"	3CT.75.402	202	60	3.54"	CCMT 1204_	6811266
6275350	A-300-75-3CT-402N	8.661"	12.598"	3CT.75.402N	202	60	3.54"	CNMG 1204_	6811270
6275355	A-400-75-3CT-300	11.417"	15.748"	3CT.75.300	272	60	3.54"	TCMT 16T3_	6811262
6275360	A-400-75-3CT-402	11.417"	15.748"	3CT.75.402	272	60	3.54"	CCMT 1204_	6811266
6275365	A-400-75-3CT-402N	11.417"	15.748"	3CT.75.402N	272	60	3.54"	CNMG 1204_	6811270
6275370	A-500-75-3CT-300	14.567"	19.685"	3CT.75.300	352	60	3.54"	TCMT 16T3_	6811262
6275375	A-500-75-3CT-402	14.567"	19.685"	3CT.75.402	352	60	3.54"	CCMT 1204_	6811266
6275380	A-500-75-3CT-402N	14.567"	19.685"	3CT.75.402N	352	60	3.54"	CNMG 1204_	6811270

SafetySET, and SpeedSET features not available on large boring heads due to their design differences.



All Techniks products are backed by our 100% satisfaction guarantee!

90° Lead Angle Finish Heads – Range .945" up to 8.661"



Integral pocket type

Features

- AccuSET spring-loaded slide won't lose position during adjustment
- .0001" dial allows fast and easy adjustments
- Designed for maximum rigidity and accuracy

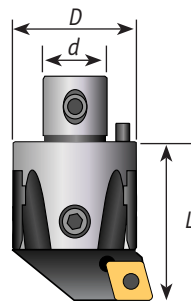

Cartridge type

90° Integral Pocket Type Finish Heads

Part No.	Description	Range		D (mm)	d (mm)	L	Insert	Screw
		Min	Max					
6390255	A-22-90-400	.945"	1.181"	22	12	1.39"	CCMT 0602_	6811250
6390260	A-27-90-409	1.142"	1.575"	27	15	1.65"	CCMT 09T3_	6811260
6390265	A-32-90-300	1.535"	1.969"	32	18	1.77"	TCMT 16T3_	6811262
6390270	A-32-90-409	1.535"	1.969"	32	18	1.77"	CCMT 09T3_	6811260
6390275	A-42-90-300	1.929"	2.559"	42	24	2.20"	TCMT 16T3_	6811262
6390280	A-42-90-402	1.929"	2.559"	42	24	2.20"	CCMT 1204_	6811266
6390285	A-42-90-402N	2.283"	2.559"	42	24	2.20"	CNMG 1204_	6811270
6390290	A-54-90-300	2.48"	3.228"	54	28	2.60"	TCMT 16T3_	6811262
6390295	A-54-90-402	2.48"	3.228"	54	28	2.60"	CCMT 1204_	6811266
6390300	A-54-90-402N	2.48"	3.228"	54	28	2.60"	CNMG 1204_	6811270

90° Cartridge Type Finish Heads

Part No.	Description	Range		Cartridge	D (mm)	d (mm)	L	Insert	Screw
		Min	Max						
6390305	A-68-90-2CT-300	3.15"	4.016"	2CT-90-300	68	36	3.39"	TCMT 16T3_	6811262
6390310	A-68-90-2CT-402	3.15"	4.016"	2CT-90-402	68	36	3.39"	CCMT 1204_	6811266
6390315	A-68-90-2CT-402N	3.15"	4.016"	2CT-90-402N	68	36	3.39"	CNMG 1204_	6811270
6390320	A-85-90-3CT-300	3.937"	4.921"	3CT-90-300	85	50	3.94"	TCMT 16T3_	6811262
6390325	A-85-90-3CT-402	3.937"	4.921"	3CT-90-402	85	50	3.94"	CCMT 1204_	6811266
6390330	A-85-90-3CT-402N	3.937"	4.921"	3CT-90-402N	85	50	3.94"	CNMG 1204_	6811270
6390335	A-100-90-3CT-300	4.921"	6.299"	3CT-90-300	110	60	3.94"	TCMT 16T3_	6811262
6390340	A-100-90-3CT-402	4.921"	6.299"	3CT-90-402	110	60	3.94"	CCMT 1204_	6811266
6390345	A-100-90-3CT-402N	4.921"	6.299"	3CT-90-402N	110	60	3.94"	CNMG 1204_	6811270
6390350	A-200-90-3CT-300	6.299"	8.661"	2CT-90-300	145	60	3.94"	TCMT 16T3_	6811262
6390355	A-200-90-3CT-402	6.299"	8.661"	3CT-90-402	145	60	3.94"	CCMT 1204_	6811266
6390360	A-200-90-3CT-402N	6.299"	8.661"	3CT-90-402N	145	60	3.94"	CNMG 1204_	6811270

90° Lead Angle Finish Heads - Range 8.661" up to 19.685"



Features

- AccuSET .0001" adjustment dial
- Designed for maximum rigidity and accuracy
- Top quality steel alloy hardened to 58-60 HRC



Inserts and Cartridges
pg. 168



Toolholders
pg. 172



Extensions & Reducers
pg. 182



Retention Knobs
pg. 200

Use 90° lead angle heads when performing blind boring, or if the desired hole is not exactly on center with your pilot hole. The 90° lead will have less tendency to follow the pilot hole.

AccuSET Adjustment Dial



Adjustable in 0.0001" increments

Metric dials available

.0001" dial allows operators to quickly set the finish head to any diameter.

Procedure:

1. Loosen locking screw
2. Remove any backlash
3. Rotate scale to desired setting
4. Tighten locking screw



Use large boring heads with direct mount toolholders or ADT 100-50 adapter and a toolholder with a 100mm connection. See page 179.

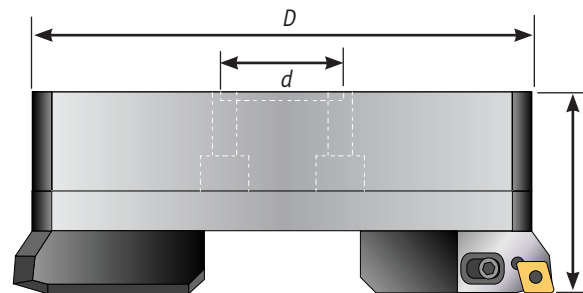

90° Large Finish Heads

Part No.	Description	Range		Cartridge	D (mm)	d (mm)	L	Insert	Screw
		Min	Max						
6390365	A-300-90-3CT-300	8.661"	12.598"	3CT-90-300	202	60	3.54"	TCMT 16T3_	6811262
6390370	A-300-90-3CT-402	8.661"	12.598"	3CT-90-402	202	60	3.54"	CCMT 1204_	6811266
6390375	A-300-90-3CT-402N	8.661"	12.598"	3CT-90-402N	202	60	3.54"	CNMG 1204_	6811270
6390380	A-400-90-3CT-300	11.417"	15.748"	3CT-90-300	272	60	3.54"	TCMT 16T3_	6811262
6390385	A-400-90-3CT-402	11.417"	15.748"	3CT-90-402	272	60	3.54"	CCMT 1204_	6811266
6390390	A-400-90-3CT-402N	11.417"	15.748"	3CT-90-402N	272	60	3.54"	CNMG 1204_	6811270
6390395	A-500-90-3CT-300	14.567"	19.685"	3CT-90-300	352	60	3.54"	TCMT 16T3_	6811262
6390400	A-500-90-3CT-402	14.567"	19.685"	3CT-90-402	352	60	3.54"	CCMT 1204_	6811266
6390405	A-500-90-3CT-402N	14.567"	19.685"	3CT-90-402N	352	60	3.54"	CNMG 1204_	6811270

SafetySET, and SpeedSET features not available on large boring heads due to their design differences.



All Techniks products are backed by our 100% satisfaction guarantee!

Indexable Cartridges 75° & 90° Lead Angle



Features

- Change lead angle or insert style by simply changing cartridges
- Precision ground accuracy
- Symmetrical or staggered boring



75° type 300



75° type 402



90° type 300



90° type 402

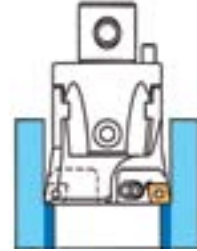
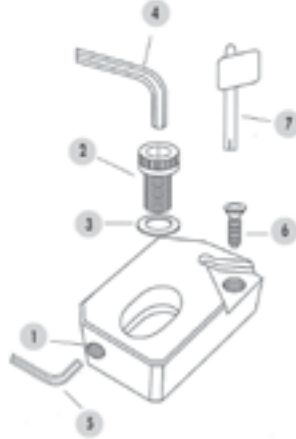

symmetrical boring

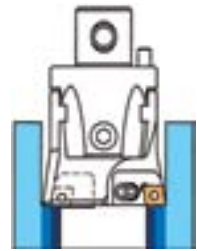

staggered boring

Staggered boring is possible by substituting a staggered cartridge in place of the regular cartridge. This .020" of axial stagger will accommodate most staggered, or "stepped" boring processes. Note that staggered cartridge descriptions end in "S".

75° Lead Angle Cartridges for Symmetrical Boring

Part No.	Description	Insert	1	2	3	4	5	6	7
6675125	2CT-75-300	TCMT 16T3_	D-68-29	A-68-26	D-68-28	H5	H2	6811260	T15
6675130	2CT-75-402	CCMT 1204_	D-68-29	A-68-26	D-68-28	H5	H2	6811266	T20
6675135	2CT-75-402N	CNMG 1204_	D-68-29	A-68-26	D-68-28	H5	H2	6811270	2.5
6675140	3CT-75-300	TCMT 16T3_	D-85-29	D-85-27	D-68-28	H5	H3	6811262	T15
6675145	3CT-75-402	CCMT 1204_	D-85-29	D-85-27	D-68-28	H5	H3	6811266	T20
6675150	3CT-75-402N	CNMG 1204_	D-85-29	D-85-27	D-68-28	H5	H3	6811270	2.5

90° Lead Angle Cartridges for Symmetrical Boring

Part No.	Description	Insert	1	2	3	4	5	6	7
6690125	2CT-90-300	TCMT 16T3_	D-68-29	A-68-26	D-68-28	H5	H2	6811260	T15
6690130	2CT-90-402	CCMT 1204_	D-68-29	A-68-26	D-68-28	H5	H2	6811266	T20
6690135	2CT-90-402N	CNMG 1204_	D-68-29	A-68-26	D-68-28	H5	H2	6811270	2.5
6690140	3CT-90-300	TCMT 16T3_	D-85-29	D-85-27	D-68-28	H5	H3	6811262	T15
6690145	3CT-90-402	CCMT 1204_	D-85-29	D-85-27	D-68-28	H5	H3	6811266	T20
6690150	3CT-90-402N	CNMG 1204_	D-85-29	D-85-27	D-68-28	H5	H3	6811270	2.5

90° Lead Angle Cartridges for Staggered Boring

Part No.	Description	Insert	1	2	3	4	5	6	7
6690155	2CT-90-300S	TCMT 16T3_	D-68-29	A-68-26	D-68-28	H5	H2	6811260	T15
6690160	2CT-90-402S	CCMT 1204_	D-68-29	A-68-26	D-68-28	H5	H2	6811266	T20
6690165	2CT-90-402NS	CNMG 1204_	D-68-29	A-68-26	D-68-28	H5	H2	6811270	2.5
6690170	3CT-90-300S	TCMT 16T3_	D-85-29	D-85-27	D-68-28	H5	H3	6811262	T15
6690175	3CT-90-402S	CCMT 1204_	D-85-29	D-85-27	D-68-28	H5	H3	6811266	T20
6690180	3CT-90-402NS	CNMG 1204_	D-85-29	D-85-27	D-68-28	H5	H3	6811270	2.5

HIGH-PERFORMANCE 3x the Thickness of Conventional PVD!

Features

- 3X thicker PVD coating
- Unique edge preparations
- Even coating thickness on the flank, nose and chip breaker



Finally, someone makes it simple!

Nexus Tool, in partnership with Lamina, introduces a type of insert technology that allows you to use just one grade for many different types of material. Simply change the feeds and speeds as required for the type of metal you are cutting, and you really can use *just one grade*.

How do we do it? Through many years of experimenting with different coating technologies, Lamina and Nexus have developed a patented, thick PVD coating that eliminates the inconsistencies and imperfections found in previous carbide coating technologies.

This coating technology features the thickest multi-layered PVD in history, and allows you to eliminate many different grades of carbide. Along with our unique edge preparations, this combination doubles tool life in some applications.

Advantages

- Just one grade
- Low inventory
- Up to double tool life

Benefits

- Increased Productivity
- Longer insert life = more parts-per-insert
- Less scrap

High-Performance Inserts

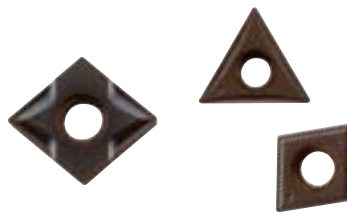

- Boring Inserts
- Milling Inserts
- Turning Inserts

Tool Life Case-Study

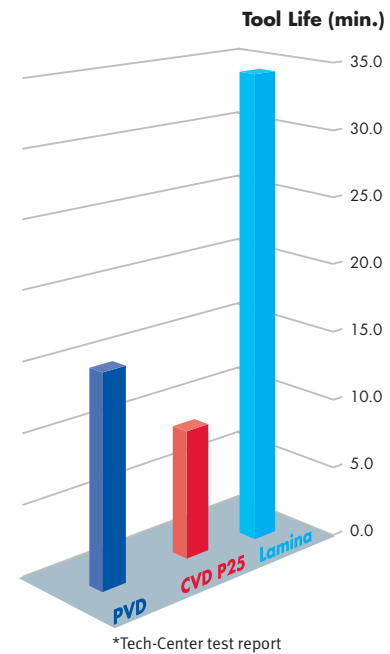

HIGH-PERFORMANCE 3x the Thickness of Conventional PVD!



Conventional PVD

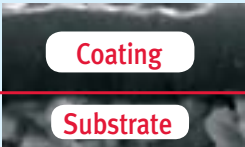

Coating

Substrate

Conventional CVD

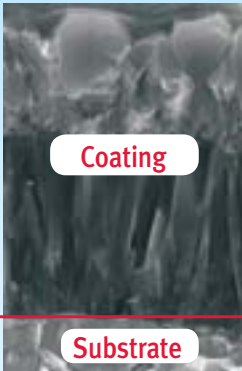

Coating

Substrate

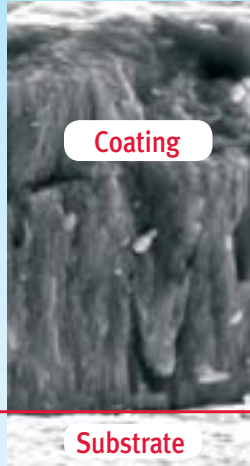

Coating

Substrate

High-Performance Boring Inserts



Features

- ISO standard inserts
- TCMT, CCMT, CNMG, EPMT, and DCMT
- Lamina high-performance insert for many types of material

Tech Tips

Roughing:

Use the largest available corner radius unless otherwise specified.

Finish boring:

Use the smallest available corner radius to minimize tool deflection.

Best finish:

Generally start with your feed at 25% of insert nose radius. Optimal speeds and feeds depend upon material, tool overhang, and setup conditions.

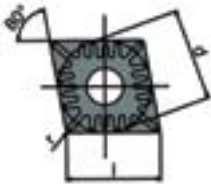

CNMG insert

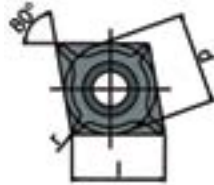

CCMT insert



TCMT insert

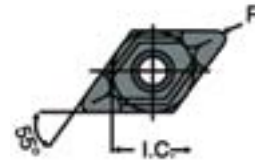

DCMT insert

HIGH-PERFORMANCE

Part No.	Description (ANSI)	Description (ISO)	Grade	Radius	Operation	Material
3631010	CCMT21.50-PF45625	CCMT060202-PF4-5625	5625	0.01	Finishing	P-M-K-S-H
3663336	CCGX21.51-LH-101	CCGX060204-LH-101	101	0.02	General	N
3664411	CCMT21.51NN-LT10	CCMT060204NN-LT10	LT10	0.02	General	P-M-K-S-H
3663399	CCMT21.52-HM-251	CCMT060208-HM-251	251	0.03	General	P-M-K-S-H
3663344	CCMT32.50-HF-251	CCMT09T302-HF-251	251	0.01	Finishing	P-M-K-S-H
3663337	CCGX32.51-LH-101	CCGX09T304-LH-101	101	0.02	General	N
3664413	CCMT32.51NN-LT10	CCMT09T304NN-LT10	LT10	0.02	General	P-M-K-S-H
3663338	CCGX32.52-LH-101	CCGX09T308-LH-101	101	0.03	General	N
3664416	CCMT32.52NN-LT10	CCMT09T308NN-LT10	LT10	0.03	General	P-M-K-S-H
3664421	CCMT431NN-LT10	CCMT120404NN-LT10	LT10	0.02	General	P-M-K-S-H
3664425	CCMT432NN-LT10	CCMT120408NN-LT10	LT10	0.03	General	P-M-K-S-H
3664431	CCMT433NN-LT10	CCMT120412NN-LT10	LT10	0.05	General	P-M-K-S-H
3663339	CCGX432-LH-101	CCGX120408-LH-101	101	0.03	General	N
6607029	CNMG431-NN-LT10	CNMG120404-NN-LT10	LT10	0.02	General	P-M-K-S-H
6607033	CNMG432-NN-LT10	CNMG120408-NN-LT10	LT10	0.03	General	P-M-K-S-H
6607037	CNMG433-NN-LT10	CNMG120412-NN-LT10	LT10	0.05	Roughing	P-M-K-S-H
6607041	CNMP432-NN-LT10	CNMP1204008-NN-LT10	LT10	0.03	General	P-M-K-S-H
6607045	CNMP433-NN-LT10	CNMP120412-NN-LT10	LT10	0.05	Roughing	P-M-K-S-H
6607901	CNGG431-ALU-LT05	CNGG120404-ALU-LT05	LT05	0.02	General	N
6607905	CNGG432-ALU-LT05	CNGG120408-ALU-LT05	LT05	0.03	General	N



CC_ _



CC_ _



CC_ _



CN_ _

P = steel, M = stainless, K = cast iron, S = high temp alloys, H = hardened material, N = aluminum & alloys

High-Performance Boring Inserts

Part No.	Description (ANSI)	Description (ISO)	Grade	Radius	Operation	Material
3764424	DCMT32.51NN-LT10	DCMT11T304NN-LT10	LT10	0.02	General	P-M-K-S-H
3764427	DCMT32.52NN-LT10	DCMT11T308NN-LT10	LT10	0.03	General	P-M-K-S-H
3763337	DCGX32.52-LH-101	DCGX11T308-LH-101	101	0.03	General	N
3732040	DCMT432-PM4-5615	DCMT150408-PM4-5615	5615	0.03	Roughing	P-M-K-S-H
3934020	EPGT1.21.5L-W08-NS530	EPGT040102L-W08-NS530	NS530	0.01	R & F	P-M-K-S-H-N
3934030	EPMT1.53.5-PM5-5625	EPMT050202-PM5-5625	5625	0.01	R & F	P-M-K-S-H-N
3533010	TCMT1.21.5-PF4-5615	TCMT06T102-PF4-5615	5615	0.01	Finishing	P-M-K-S-H
3533020	TCMT1.211-PF4-5625	TCMT06T104-PF4-5625	5625	0.02	Finishing	P-M-K-S-H
3563311	TCMT1.81.50-HF-251	TCMT090202-HF-251	251	0.01	Finishing	P-M-K-S-H
3563388	TCMT1.81.51-HM-251	TCMT090204-HM-251	251	0.02	General	P-M-K-S-H
3533030	TCMT1.81.51-PF4-5625	TCMT090204-PF4-5625	5625	0.02	Finishing	P-M-K-S-H
3563399	TCMT1.81.52-HM-251	TCMT090208-HM-251	251	0.03	General	P-M-K-S-H
3564438	TCMT32.51NN-LT30	TCMT16T304NN-LT10	LT10	0.02	General	P-M-K-S-H
3563337	TCGX32.52-LH	TCGX16T308-LH-101	101	0.03	General	N
3564441	TCMT32.52NN-LT10	TCMT16T308NN-LT10	LT10	0.03	General	P-M-K-S-H



Part No.	Description	Grade	Radius	Operation	Material
3668011	CCMT21.51NN-LT1000-Insert	LT1000	0.016	Finishing	P-M-K-S-H
3668021	CCMT32.51NN-LT1000-Insert	LT1000	0.016	Finishing	P-M-K-S-H
3668026	CCMT32.52NN-LT1000-Insert	LT1000	0.031	General	P-M-K-S-H
6608011	CNMG431NN-LT1000-Insert	LT1000	0.016	Finishing	P-M-K-S-H
6608016	CNMG432NN-LT1000-Insert	LT1000	0.031	General	P-M-K-S-H
6608026	CNMG432NX-LT1000-Insert	LT1000	0.031	General	P-M-K-S-H
6608021	CNMG433NN-LT1000-Insert	LT1000	0.047	Roughing	P-M-K-S-H
6608031	CNMP432NN-LT1000-Insert	LT1000	0.031	General	P-M-K-S-H
6608036	CNMP433NN-LT1000-Insert	LT1000	0.047	Roughing	P-M-K-S-H
3768821	DCMT32.51NN-LT1000-Insert	LT1000	0.016	Finishing	P-M-K-S-H
3768826	DCMT32.52NN-LT1000-Insert	LT1000	0.031	General	P-M-K-S-H
3568831	TCMT21.51NN-LT1000-Insert	LT1000	0.016	Finishing	P-M-K-S-H
3568841	TCMT21.52NN-LT1000-Insert	LT1000	0.031	General	P-M-K-S-H
3568851	TCMT32.51NN-LT1000-Insert	LT1000	0.016	Finishing	P-M-K-S-H
3568861	TCMT32.52NN-LT1000-Insert	LT1000	0.031	General	P-M-K-S-H



P = steel, M = stainless, K = cast iron, S = high temp alloys, H = hardened material, N = aluminum & alloys

Pinzbohr High Precision CAT40 Toolholders



Match the *d* dimension on toolholder and boring head for proper selection.

Features

- Exceed industry standards for taper accuracy and concentricity
- Two offset axial tapered locking screws maximize rigidity and allow fast tool changes
- Reducers allow different boring heads to be used with the same toolholder
- Extensions allow more depth

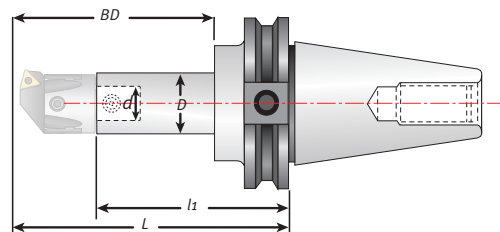

Boring Heads
pg. 160



Inserts and Cartridges
pg. 168



Extensions & Reducers
pg. 182



Retention Knobs
pg. 200

CAT40 Boring Toolholders

Boring depth (BD) is tool length plus boring head.

Part No.	Description	D (mm)	d (mm)	BD	L	l1	Coupling Screw
6133250	CT-340-22-80	22	12	3.150"	4.65"	3.31"	6811510
6133255	CT-340-22-100	22	12	3.937"	4.09"	3.94"	6811510
6133260	CT-340-27-55	27	15	2.165"	3.54"	1.89"	6811520
6133265	CT-340-27-100	27	15	3.937"	3.78"	3.94"	6811520
6133270	CT-340-27-130	27	15	5.118"	4.96"	5.12"	6811520
6133275	CT-340-32-60	32	20	2.362"	2.01"	2.36"	6811530
6133280	CT-340-32-100	32	20	3.937"	3.66"	3.94"	6811530
6133285	CT-340-32-130	32	20	5.118"	4.84"	5.12"	6811530
6133290	CT-340-42-75	42	24	2.953"	4.41"	2.20"	6811540
6133295	CT-340-42-120	42	24	4.724"	5.59"	4.72"	6811540
6134300	CT-340-42-160	42	24	6.300"	7.17"	4.96"	6811540
6134305	CT-340-42-200	42	24	7.874"	8.74"	6.54"	6811540
6134310	CT-340-54-120	54	28	4.724"	5.59"	2.99"	6811550
6134315	CT-340-54-160	54	28	6.300"	7.17"	4.57"	6811550
6134320	CT-340-54-200	54	28	7.874"	8.74"	6.14"	6811550
6134325	CT-340-68-160	68	36	6.300"	7.20"	3.82"	6811560
6134330	CT-340-68-200	68	36	7.874"	8.78"	5.39"	6811560
6134335	CT-340-085-200	85	50	7.874"	8.819"	4.88"	6811570
6134340	CT-340-100-200	100	60	7.874"	8.819"	4.88"	6811580

For large head toolholders, see page 180.

Pinzbohr High Precision CAT40 Coolant-Thru Toolholders



Match the "d" dimension on toolholder and boring head for proper selection.

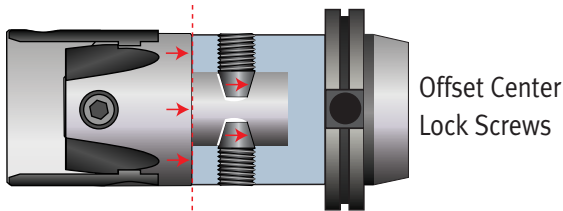

Our **modular coupling system** allows heads to be changed without removing tools from the spindle. Two offset center lock screws apply maximum tightening force between the boring head and the toolholder. This increases rigidity and enhances vibration dampening characteristics.

Features

- Exceed industry standards for taper accuracy and concentricity
- Two offset axial tapered locking screws maximize rigidity and allow fast tool changes
- Reducers allow different boring heads to be used with the same toolholder
- Extensions allow more depth

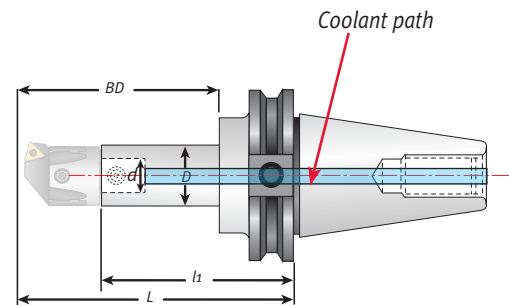

Use with coolant-thru extensions - pg. 182

Boring depth (BD) is tool length plus boring head.

CAT40 Coolant-thru

Part No.	Description	D (mm)	d (mm)	BD	L	I1	Coupling Screw
6133257	CT-340-22-100-R	22	12	3.937"	4.09"	3.94"	6811510
6133252	CT-340-22-80-R	22	12	3.150"	4.65"	3.31"	6811510
6133267	CT-340-27-100-R	27	15	3.937"	3.78"	3.94"	6811520
6133272	CT-340-27-130-R	27	15	5.118"	4.96"	5.12"	6811520
6133262	CT-340-27-55-R	27	15	2.165"	3.54"	1.89"	6811520
6133282	CT-340-32-100-R	32	20	3.937"	3.66"	3.94"	6811530
6133287	CT-340-32-130-R	32	15	5.118"	4.96"	5.12"	6811520
6133277	CT-340-32-60-R	32	20	2.362"	2.01"	2.36"	6811530
6133297	CT-340-42-120-R	42	24	4.724"	5.59"	4.72"	6811540
6134302	CT-340-42-160-R	42	24	6.300"	7.17"	4.96"	6811540
6134307	CT-340-42-200-R	42	24	7.874"	8.74"	6.54"	6811540
6133292	CT-340-42-75-R	42	24	2.953"	4.41"	2.20"	6811540
6134312	CT-340-54-120-R	54	28	4.724"	5.59"	2.99"	6811550
6134317	CT-340-54-160-R	54	28	6.300"	7.17"	4.57"	6811550
6134322	CT-340-54-200-R	54	28	7.874"	8.74"	6.14"	6811550
6134327	CT-340-68-160-R	68	36	6.300"	7.20"	3.82"	6811560
6134332	CT-340-68-200-R	68	36	7.874"	8.78"	5.39"	6811560

For large head toolholders, see page 180.



All Techniks products are backed by our 100% satisfaction guarantee!

Pinzbohr High Precision CAT50 Toolholders



Match the *d* dimension on toolholder and boring head for proper selection.

Features

- Exceed industry standards for taper accuracy and concentricity
- Two offset axial tapered locking screws maximize rigidity and allow fast tool changes
- Reducers allow different boring heads to be used with the same toolholder
- Extensions allow more depth

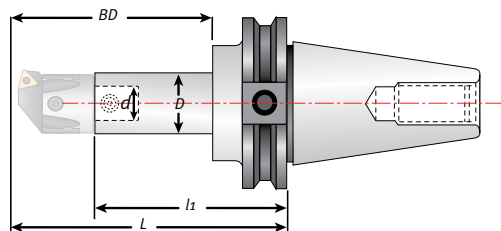

Boring depth (BD) is tool length plus boring head.

CAT50 Boring Toolholders

Part No.	Description	D (mm)	d (mm)	BD	L	l1	Coupling Screw
6141250	CT-350-22-80	22	12	3.150"	4.65"	3.31"	6811510
6141255	CT-350-22-100	22	12	3.937"	5.43"	4.09"	6811510
6141260	CT-350-27-55	27	15	2.165"	3.54"	1.89"	6811520
6141265	CT-350-27-100	27	15	3.937"	5.43"	3.78"	6811520
6141270	CT-350-27-130	27	15	5.118"	6.61"	4.96"	6811520
6141275	CT-350-32-60	32	20	2.362"	3.78"	2.01"	6811530
6141280	CT-350-32-130	32	20	5.118"	6.61"	4.84"	6811530
6141285	CT-350-32-160	32	20	6.299"	7.80"	6.02"	6811530
6141290	CT-350-42-75	42	24	2.953"	4.41"	2.20"	6811540
6141295	CT-350-42-160	42	24	6.299"	7.80"	5.59"	6811540
6141300	CT-350-42-200	42	24	7.874"	9.37"	7.17"	6811540
6141305	CT-350-54-90	54	28	3.543"	5.04"	2.44"	6811550
6141310	CT-350-54-160	54	28	6.299"	7.80"	5.20"	6811550
6141315	CT-350-54-200	54	28	7.874"	9.37"	6.77"	6811550
6141320	CT-350-68-115	68	36	4.528"	5.94"	2.56"	6811560
6141325	CT-350-68-200	68	36	7.874"	8.78"	5.39"	6811560
6141330	CT-350-68-260	68	36	10.236"	11.14"	7.76"	6811560
6141335	CT-350-85-200	85	50	7.874"	8.82"	4.88"	6811570
6141340	CT-350-85-260	85	50	10.236"	11.18"	7.24"	6811570
6141345	CT-350-85-320	85	50	12.598"	13.54"	9.61"	6811570
6141350	CT-350-100-190	100	60	7.480"	8.43"	4.49"	6811580
6141355	CT-350-100-260	100	60	10.236"	11.18"	7.24"	6811580
6141360	CT-350-100-320	100	60	12.598"	13.54"	9.61"	6811580
6166124	CT-550-160*	-	-	4.921"	6.30"	-	6811590

For large head toolholders, see page 180.

Pinzbohr High Precision CAT50 Coolant-Thru Toolholders



Match the *d* dimension on toolholder and boring head for proper selection.

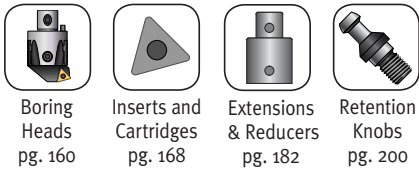

Boring Heads
pg. 160

Inserts and Cartridges
pg. 168

Extensions & Reducers
pg. 182

Retention Knobs
pg. 200

Features

- Exceed industry standards for taper accuracy and concentricity
- Two offset axial tapered locking screws maximize rigidity and allow fast tool changes
- Reducers allow different boring heads to be used with the same toolholder
- Extensions allow more depth

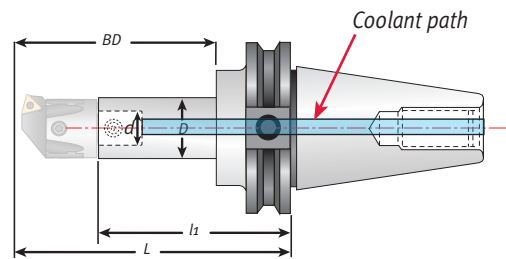

Use with coolant-thru extensions - pg. 182

Boring depth (BD) is tool length plus boring head.

CAT50 Coolant-thru

Part No.	Description	D (mm)	d (mm)	BD	L	l1	Coupling Screw
6141252	CT-350-22-80-R	22	12	3.150"	4.65"	3.31"	6811510
6141257	CT-350-22-100-R	22	12	3.937"	5.43"	4.09"	6811510
6141262	CT-350-27-55-R	27	15	2.165"	3.54"	1.89"	6811520
6141267	CT-350-27-100-R	27	15	3.937"	5.43"	3.78"	6811520
6141272	CT-350-27-130-R	27	15	5.118"	6.61"	4.96"	6811520
6141277	CT-350-32-60-R	32	20	2.362"	3.78"	2.01"	6811530
6141282	CT-350-32-130-R	32	20	5.118"	6.61"	4.84"	6811530
6141287	CT-350-32-160-R	32	20	6.299"	7.80"	6.02"	6811530
6141292	CT-350-42-75-R	42	24	2.953"	4.41"	2.20"	6811540
6141297	CT-350-42-160-R	42	24	6.299"	7.80"	5.59"	6811540
6141302	CT-350-42-200-R	42	24	7.874"	9.37"	7.17"	6811540
6141307	CT-350-54-90-R	54	28	3.543"	5.04"	2.44"	6811550
6141312	CT-350-54-160-R	54	28	6.299"	7.80"	5.20"	6811550
6141317	CT-350-54-200-R	54	28	7.874"	9.37"	6.77"	6811550
6141322	CT-350-68-115-R	68	36	4.528"	5.94"	2.56"	6811560
6141327	CT-350-68-200-R	68	36	7.874"	8.78"	5.39"	6811560
6141332	CT-350-68-260-R	68	36	10.236"	11.14"	7.76"	6811560
6141337	CT-350-85-200-R	85	50	7.874"	8.82"	4.88"	6811570
6141342	CT-350-85-260-R	85	50	10.236"	11.18"	7.24"	6811570
6141347	CT-350-85-320-R	85	50	12.598"	13.54"	9.61"	6811570
6141352	CT-350-100-190-R	100	60	7.480"	8.43"	4.49"	6811580
6141362	CT-350-100-320-R	100	60	12.598"	13.54"	9.61"	6811580

For large head toolholders, see page 180.



All Techniks products are backed by our 100% satisfaction guarantee!

Pinzbohr High Precision BT30, BT40 Toolholders



Match the *d* dimension on toolholder and boring head for proper selection.

Boring depth (BD) is tool length plus boring head.

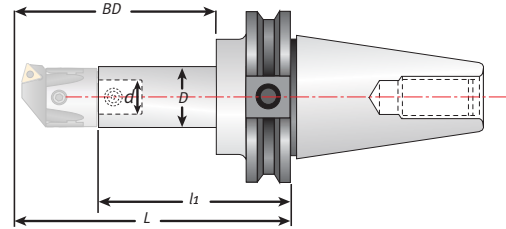

Features

- Exceed industry standards for taper accuracy and concentricity
- Two offset axial tapered locking screws maximize rigidity and allow fast tool changes
- Reducers allow different boring heads to be used with the same toolholder
- Extensions allow more depth

BT30 Boring Toolholders

Part-No.	Description	D (mm)	d (mm)	BD	L	l1	Coupling-Screw
6130100	BT-330-22-100	22	12	3.937"	4.92"	3.58"	6811510
6130150	BT-330-27-55	27	15	2.165"	3.03"	1.38"	6811520
6130200	BT-330-27-100	27	15	3.937"	4.92"	3.27"	6811520
6130250	BT-330-32-60	32	20	2.362"	3.27"	1.50"	6811530
6130300	BT-330-32-100	32	20	3.937"	4.92"	3.15"	6811530

BT40 Boring Toolholders

Part-No.	Description	D (mm)	d (mm)	BD	L	l1	Coupling-Screw
6140100	BT-340-22-50	22	12	1.969"	3.15"	1.81"	6811510
6140125	BT-340-22-80	22	12	3.150"	4.33"	2.99"	6811510
6140150	BT-340-22-100	22	12	3.937"	5.12"	3.78"	6811510
6140175	BT-340-27-55	27	15	2.165"	3.23"	1.57"	6811520
6140200	BT-340-27-100	27	15	3.937"	5.12"	3.46"	6811520
6140225	BT-340-27-130	27	15	5.118"	6.30"	4.65"	6811520
6140250	BT-340-32-60	32	20	2.362"	3.46"	1.69"	6811530
6140275	BT-340-32-100	32	20	3.937"	5.12"	3.35"	6811530
6140300	BT-340-32-130	32	20	5.118"	6.30"	4.53"	6811530
6140325	BT-340-42-75	42	24	2.953"	4.09"	1.89"	6811540
6140350	BT-340-42-160	42	24	6.299"	7.48"	5.28"	6811540
6140375	BT-340-42-200	42	24	7.874"	9.06"	6.85"	6811540
6140400	BT-340-54-90	54	28	3.543"	4.72"	2.13"	6811550
6140425	BT-340-54-160	54	28	6.299"	7.48"	4.88"	6811550
6140450	BT-340-54-200	54	28	7.874"	9.06"	6.46"	6811550
6140475	BT-340-68-160	68	36	6.299"	7.13"	3.74"	6811560
6140500	BT-340-68-200	68	36	7.874"	8.70"	5.31"	6811560
6140525	BT-340-85-200	85	50	7.874"	8.66"	4.72"	6811570
6140550	BT-340-100-200	100	60	7.874"	8.66"	4.72"	6811580

For large head toolholders, see page 180.

Pinzbohr High Precision BT50 Toolholders



Features

- Exceed industry standards for taper accuracy and concentricity
- Two offset axial tapered locking screws maximize rigidity and allow fast tool changes
- Reducers allow different boring heads to be used with the same toolholder
- Extensions allow more depth

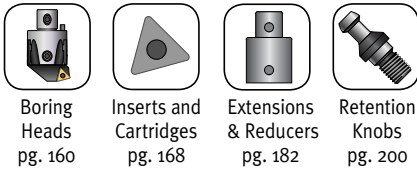

Boring Heads
pg. 160

Inserts and Cartridges
pg. 168

Extensions & Reducers
pg. 182

Retention Knobs
pg. 200

Match the *d* dimension on toolholder and boring head for proper selection.

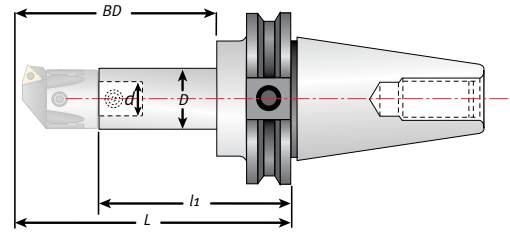

Boring depth (BD) is tool length plus boring head.

BT50 Boring Toolholders

Part No.	Description	D (mm)	d (mm)	BD	L	l1	Coupling Screw
6150100	BT-350-22-80	22	12	3.150"	4.76"	3.43"	6811510
6150125	BT-350-22-100	22	12	3.937"	5.55"	4.21"	6811510
6150150	BT-350-27-55	27	15	2.165"	3.66"	2.01"	6811520
6150175	BT-350-27-100	27	15	3.937"	5.55"	3.90"	6811520
6150200	BT-350-27-130	27	15	5.118"	6.73"	5.08"	6811520
6150225	BT-350-32-60	32	20	2.362"	3.90"	2.13"	6811530
6150250	BT-350-32-130	32	20	5.118"	6.73"	4.96"	6811530
6150275	BT-350-32-160	32	20	6.299"	7.91"	6.14"	6811530
6150300	BT-350-42-75	42	24	2.953"	4.53"	2.32"	6811540
6150325	BT-350-42-160	42	24	6.299"	7.91"	5.71"	6811540
6150350	BT-350-42-200	42	24	7.874"	9.49"	7.28"	6811540
6150375	BT-350-54-90	54	28	3.543"	5.16"	2.56"	6811550
6150400	BT-350-54-160	54	28	6.299"	7.91"	5.31"	6811550
6150425	BT-350-54-200	54	28	7.874"	9.49"	6.89"	6811550
6150450	BT-350-68-115	68	36	4.528"	6.06"	2.68"	6811560
6150475	BT-350-68-200	68	36	7.874"	9.53"	6.14"	6811560
6150500	BT-350-68-260	68	36	10.236"	11.89"	8.50"	6811560
6150525	BT-350-85-200	85	50	7.874"	9.53"	5.59"	6811570
6150550	BT-350-85-260	85	50	10.236"	11.89"	7.95"	6811570
6150575	BT-350-85-320	85	50	12.598"	14.25"	10.31"	6811570
6150600	BT-350-100-170	100	60	6.693"	7.68"	3.74"	6811580
6150625	BT-350-100-260	100	60	10.236"	11.89"	7.95"	6811580
6150650	BT-350-100-320	100	60	12.598"	14.25"	10.31"	6811580
6166123	BT-550-160*	100	-	4.921"	6.30"	2.76"	6811590

For large head toolholders, see page 180.



All Techniks products are backed by our 100% satisfaction guarantee!

Pinzbohr High Precision HSK50A, 63A, 100A Toolholders



Match the *d* dimension on toolholder and boring head for proper selection.

Features

- Exceed industry standards for taper accuracy and concentricity
- Two offset axial tapered locking screws maximize rigidity and allow fast tool changes
- Reducers allow different boring heads to be used with the same toolholder

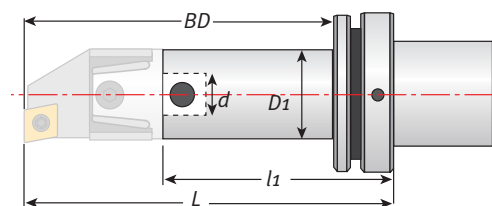

Boring depth (BD) is tool length plus boring head.

HSK50A Boring Toolholders

Part No.	Description	D1 (mm)	d (mm)	BD	L	l1	Coupling Screw
6155501	HSK-50A-22-55	22	12	2.165"	3.19"	1.85"	6811510
6155502	HSK-50A-27-65	27	15	2.559"	3.58"	1.93"	6811520
6155503	HSK-50A-32-75	32	20	2.953"	3.98"	2.20"	6811530
6155504	HSK-50A-42-90	42	24	3.543"	4.57"	2.36"	6811540

HSK63A Boring Toolholders

Part No.	Description	D1 (mm)	d (mm)	BD	L	l1	Coupling Screw
6155631	HSK-63A-22-55	22	12	2.165"	3.19"	1.85"	6811510
6155632	HSK-63A-27-65	27	15	2.559"	3.58"	1.93"	6811520
6155633	HSK-63A-32-75	32	20	2.953"	3.98"	2.20"	6811530
6155634	HSK-63A-42-90	42	24	3.543"	4.57"	2.36"	6811540
6155635	HSK-63A-54-110	54	28	4.331"	5.35"	2.76"	6811550
6155636	HSK-63A-68-145	68	36	5.709"	6.73"	3.35"	6811560

HSK100A Boring Toolholders

Part No.	Description	D1 (mm)	d (mm)	BD	L	l1	Coupling Screw
6155101	HSK-100A-22-55	22	12	2.165"	3.50"	1.85"	6811510
6155102	HSK-100A-27-65	27	15	2.559"	3.90"	1.93"	6811520
6155103	HSK-100A-32-75	32	20	2.953"	4.09"	2.20"	6811530
6155104	HSK-100A-42-90	42	24	3.543"	4.69"	2.36"	6811540
6155105	HSK-100A-54-110	54	28	4.331"	5.47"	2.76"	6811550
6155106	HSK-100A-68-145	68	36	5.709"	6.85"	3.46"	6811560
6155107	HSK-100A-85-165	85	50	6.496"	7.64"	3.70"	6811570
6155108	HSK-100A-100-185	100	60	7.283"	8.43"	4.49"	6811580

For large head toolholders, see page 180.

Pinzbohr High Precision Weldon & R8 Toolholders



Weldon toolholder

Match the d dimension on toolholder and boring head for proper selection.

Features

- Convert your end mill holder into a precision boring head holder.
- Two offset axial tapered locking screws maximize rigidity and allow fast tool changes

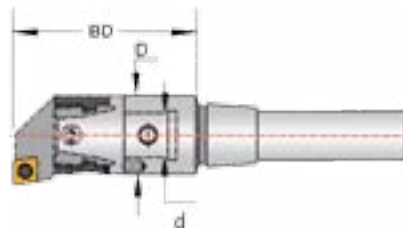

Boring depth (BD) is tool length plus boring head.

Weldon 3/4" Shank

Part No.	Description	D (mm)	d (mm)	BD	Coupling Screws
6165341	B-20-22-50-3/4-SS-WELDON	22	12	1.772"	6811510
6165342	B-20-22-100-3/4-SS-WELDON	22	12	3.937"	6811510
6165343	B-20-54-110-3/4-SS-WELDON	54	28	4.331"	6811550

Weldon 1" Shank

Part No.	Description	D (mm)	d (mm)	BD	Coupling Screws
6165101	B-25-27-55-1.0-SS-WELDON	27	15	1.969"	6811520
6165102	B-25-27-100-1.0-SS-WELDON	27	15	3.740"	6811520
6165103	B-25-54-110-1.0-SS-WELDON	54	28	4.331"	6811550

Weldon 1-1/4" Shank

Part No.	Description	D (mm)	d (mm)	BD	Coupling Screws
6165141	B-32-32-60-1-1/4-SS-WELDON	32	20	2.362"	6811530
6165142	B-32-32-100-1-1/4-SS-WELDON	32	20	3.937"	6811530
6165143	B-32-42-90-1-1/4-SS-WELDON	42	24	3.543"	6811540
6165144	B-32-54-110-1-1/4-SS-WELDON	54	28	4.331"	6811550

Weldon 1-1/2" Shank

Part No.	Description	D (mm)	d (mm)	BD	Coupling Screws
6165121	B-40-42-90-1-1/2-SS-WELDON	42	24	3.543"	6811540
6165122	B-40-42-160-1-1/2-SS-WELDON	42	24	6.299"	6811540
6165123	B-40-54-110-1-1/2-SS-WELDON	54	28	4.331"	6811550

R8 Toolholders

Part No.	Description	D (mm)	d (mm)	BD	Coupling Screws
6165801	R8-22-50-R8-WELDON	22	12	1.969"	6811510
6165802	R8-27-60-R8-WELDON	27	15	2.362"	6811520
6165803	R8-32-75-R8-WELDON	32	20	2.953"	6811530
6165804	R8-42-90-R8-WELDON	42	24	3.543"	6811540
6165805	R8-54-110-R8-WELDON	54	28	4.331"	6811550



R8 Tool holder

Toolholders for Large Boring Heads



Features

- Direct mount system maximizes rigidity and accuracy
- For CAT50 and BT50 spindles
- Use with large heads pgs. 161, 163, 165, 167



Boring Heads
pg. 160



Inserts and Cartridges
pg. 168



Extensions & Reducers
pg. 182



Retention Knobs
pg. 200

Direct Mount Toolholders for Large Boring Heads

Part No.	Description	BD	L (mm)	Coupling Screw
6166123	BT-550-160	4.921	160	6811590
6166124	CT-550-160	4.921	160	6811590

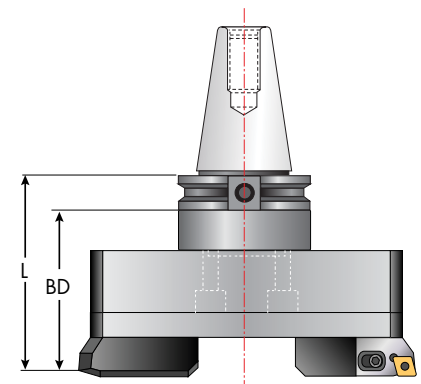

ADT 100-50 adapter

Features

- Adapter works with 100mm connection toolholders
- CAT, BT, and HSK spindles
- Use with large heads pgs. 161, 163, 165, 167

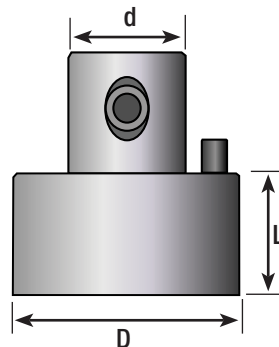

toolholder

ADT 100-50
adapter

large boring head

Large Head Adapter Mount

Part No.	Description	D	d	L
6022510	ADT-100-50 Large head adapter	100	60	50

Use with all toolholders that have 100mm connections. Adds 50mm length.

Large Head Mounting Instructions

Finish Heads

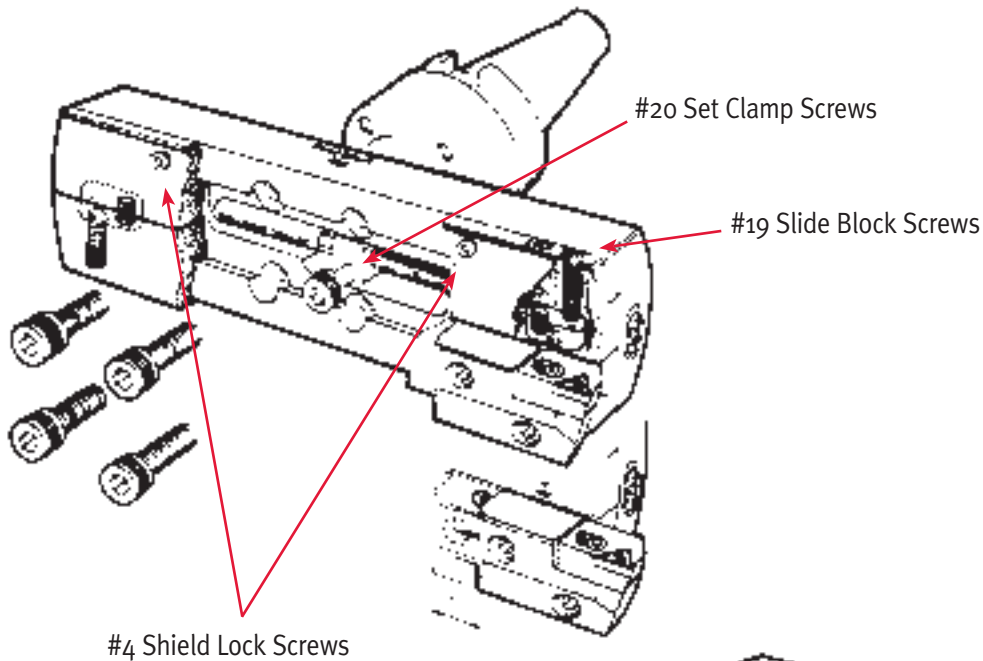

Rough Heads

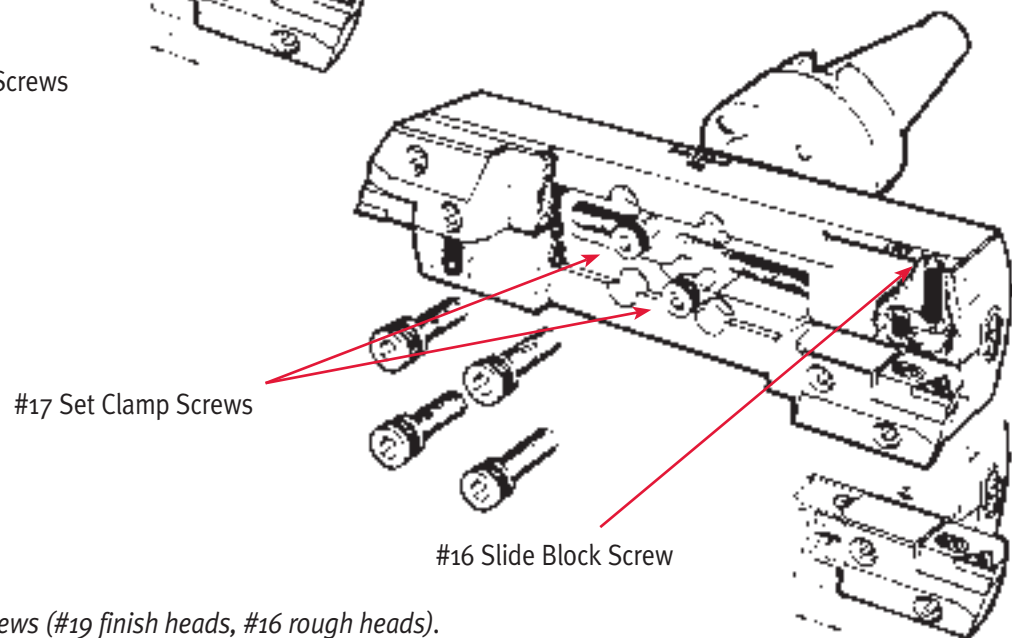

1. Loosen slide block screws (#19 finish heads, #16 rough heads).
2. Remove set clamp screws (#20 finish heads, #17 rough heads).
3. On finish boring heads only, remove shield lock screws #4.
4. Move slide blocks /shield off-center until the four counter bored bolt holes located in the body below the slide blocks are completely exposed.
5. Place taper shank holder or adapter on back side of boring head with pilot completely engaged in pilot cavity.
6. Insert 4 socket head cap screws into counter bored holes and tighten to 90 ft-lbs torque.
7. Push slide blocks back into position to line up with threaded holes below.
8. Insert nut /close shield lock screws and tighten.
9. Adjust boring head to desired diameter and tighten slide block lock screws.

Pinzbohr High Precision Extensions



Match the *d* dimensions on toolholder, extension, and boring head for proper selection.

Features

- Two offset axial tapered locking screws maximize rigidity and allow fast tool changes

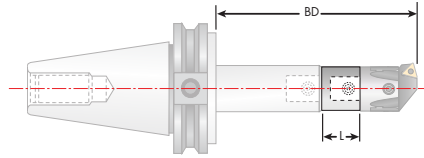

Calculate needed extension length (*L*) to achieve your boring depth (*BD*)



Boring Heads
pg. 160



Inserts and Cartridges
pg. 168



Retention Knobs
pg. 200

Standard Extensions

Part No.	Description	D (mm)	d (mm)	L	Coupling Screw
6552220	P-22-20	22	12	0.79"	6811510
6552230	P-22-30	22	12	1.18"	6811510
6552730	P-27-30	27	15	1.18"	6811520
6552745	P-27-45	27	15	1.77"	6811520
6553235	P-32-35	32	20	1.38"	6811530
6553252	P-32-52	32	20	2.05"	6811530
6554240	P-42-40	42	24	1.57"	6811540
6554260	P-42-60	42	24	2.36"	6811540
6555450	P-54-50	54	28	1.97"	6811550
6555475	P-54-75	54	28	2.95"	6811550
6556860	P-68-60	68	36	2.36"	6811560
6556890	P-68-90	68	36	3.54"	6811560
6558570	P-85-70	85	50	2.76"	6811570
6558510	P-85-105	85	50	4.13"	6811570
6551080	P-100-80	100	60	3.15"	6811580
6551012	P-100-120	100	60	4.72"	6811580

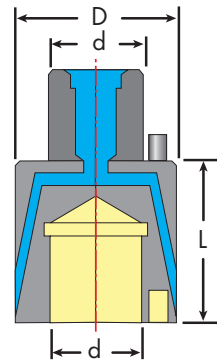
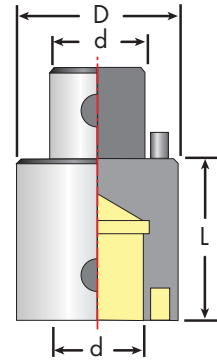

Coolant-thru Spindle Extension

Part No.	Description	D (mm)	d (mm)	L	Coupling Screw
6562230	P-22-30R	22	12	1.18"	6811510
6562730	P-27-30R	27	15	1.18"	6811520
6563235	P-32-35R	32	20	1.38"	6811530
6564240	P-42-40R	42	24	1.57"	6811540
6565450	P-54-50R	54	28	1.97"	6811550
6566860	P-68-60R	68	36	2.36"	6811560
6568570	P-85-70R	85	50	2.76"	6811570
6561080	P-100-80R	100	60	3.15"	6811580

Coolant-thru Spindle Extension

The coolant-thru spindle extension provides coolant to the cutting zone for optimal stock removal rates.

Minimum recommend coolant pressure is 70 psi. Coolant is directed onto cutting edge by adapter.

Use with coolant-thru toolholders available upon request.

Pinzbohr High Precision Reducers & Chamfering Heads



Features

- Two offset axial tapered locking screws maximize rigidity and allow fast tool changes
- Reducers allow different boring heads to be used with the same toolholder / extension combination

Match the *d* dimensions on toolholder, reducer, and boring head for proper selection.

Reducers

Part No.	Description	D (mm)	d (mm)	D1 (mm)	d1 (mm)	L	c	Coupling Screw
6442236	R--27-22-36	27	15	22	12	1.02"	.39"	6811510
6442240	R--32-22-40	32	20	22	12	1.18"	.39"	6811510
6442258	R--42-22-58	42	24	22	12	1.89"	.39"	6811510
6442286	R--54-22-86	54	28	22	12	2.99"	.39"	6811510
6442210	R-68-22-102	68	36	22	12	3.54"	.47"	6811510
6442734	R-32-72-34	32	20	27	15	0.94"	.39"	6811520
6442750	R-42-27-50	42	24	27	15	1.57"	.39"	6811520
6442780	R-54-27-80	54	28	27	15	2.76"	.39"	6811520
6442795	R-68-27-95	68	36	27	15	3.27"	.47"	6811520
6443246	R-42-32-46	42	24	32	20	1.42"	.39"	6811530
6443276	R-54-32-76	54	28	32	20	2.60"	.39"	6811530
6443290	R-68-32-90	68	36	32	20	3.07"	.47"	6811530
6444270	R-54-42-70	54	28	42	24	2.36"	.39"	6811540
6444282	R-68-42-82	68	36	42	24	2.76"	.47"	6811540
6444295	R-85-42-95	85	50	42	24	3.27"	.47"	6811540
6445472	R-68-54-72	68	36	54	28	2.36"	.47"	6811550
6445490	R-85-54-90	85	50	54	28	3.07"	.47"	6811550
6446810	R-85-68-100	85	50	68	36	3.46"	.47"	6811560
6448510	R-100-85-100	100	60	85	50	3.46"	.47"	6811570

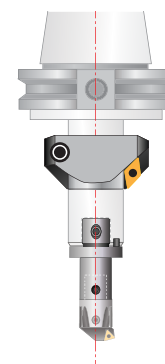
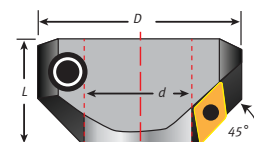
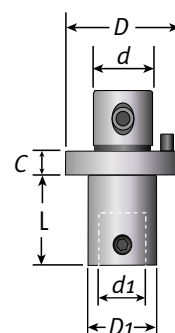

45° Chamfering Heads

Part No.	Desc.	D (mm)	d (mm)	L	Insert	Insert Screw	Wrench	Locking Key
6033311	CH-22	43	22	0.94"	DCMT 11T3_	6811260	T15	4 hex
6033322	CH-27	48	27	0.94"	DCMT 11T3_	6811260	T15	4 hex
6033333	CH-32	62	32	1.18"	DCMT 11T3_	6811260	T15	5 hex
6033344	CH-42	72	42	1.18"	DCMT 11T3_	6811260	T15	5 hex
6033355	CH-54	94	54	1.57"	DCMT 150408	6811266	T20	6 hex
6033366	CH-68	110	68	1.57"	DCMT 150408	6811266	T20	8 hex
6033377	CH-85	145	85	2.17"	DCMT 150408	6811266	T20	10 hex
6033388	CH-100	170	100	2.36"	DCMT 150408	6811266	T20	14 hex
6033399	CH-200	200	100	2.36"	DCMT 150408	6811266	T20	14 hex

High Precision End Mill Holders & Face Mill Arbors

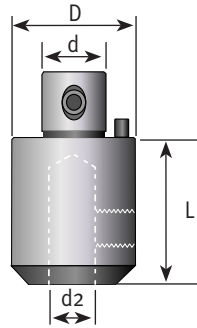

Features

- For 1/4" up to 3/4" end mills
- Use with extra-long toolholders and extensions for extended length applications
- Two offset center lock screws maximize rigidity while still permitting fast tool changes



Boring Heads
pg. 160



Inserts and Cartridges
pg. 168



Extensions & Reducers
pg. 182



Retention Knobs
pg. 200

End Mill Holders

Part No.	Description	D (mm)	d (mm)	L	d2
6123300	ADM-42-1/4	42	24	1.38"	1/4"
6123305	ADM-42-3/8	42	24	1.50"	3/8"
6123310	ADM-42-1/2	42	24	2.17"	1/2"
6123315	ADM-42-3/4	42	28	2.83"	3/4"
6123320	ADM-54W-3/4	54	28	2.85"	3/4"

Features

- For 3/4" up to 1-1/4" face mills
- Two offset center lock screws maximize rigidity while still permitting fast tool changes
- Use with extra-long toolholders and extensions for extended length applications

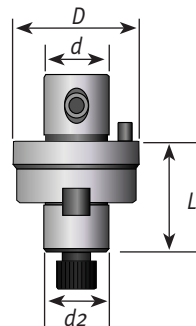

Face Mill Arbor

Part No.	Description	D (mm)	d (mm)	L	d2
6133300	ADM-54-34	54	28	1.97"	3/4"
6133305	ADM-54-10	54	28	1.97"	1.0"
6133310	ADM-68-10	68	36	1.97"	1.0"
6133315	ADM-68-114	68	36	1.97"	1-1/4"

Modular Coupling System

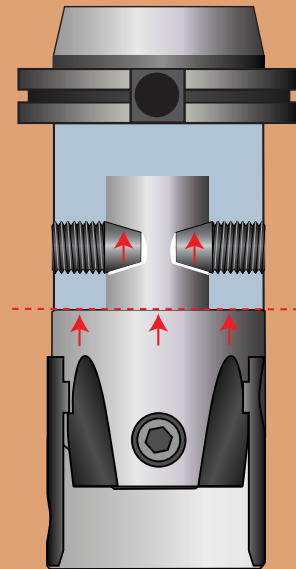

Offset Center Lock Screws

Pin and taper coupling system allows tools to be changed without removing from the spindle. Two offset center lock screws apply maximum tightening force between the tool and the toolholder. This increases rigidity and enhances vibration damping characteristics.

Pinzbohr Speeds & Feeds Guidelines

Optimal speeds & feeds depend upon material, machine, tool overhang, and setup. These guidelines may not be correct for your application, but can serve as a useful starting point.

Rough Boring with Dual Inserts

Material: Plain Carbon Steel

Dia. Range (inch)	Head Size	Max. Stock Removal on Dia.	Suggested Speeds SFM	Suggested Feeds IPR
.944 - 1.181	22	0.38	320 - 420	.006 - .010
1.141 - 1.574	27	0.47	350 - 450	.006 - .012
1.535 - 1.968	32	0.56	350 - 500	.008 - .012
1.929 - 4.015	42, 54, 68	0.75	350 - 500	.010 - .014
3.935 - 20.00	85, 100, 200	0.84	350 - 500	.012 - .016
	300, 400, 500		350 - 500	.012 - .016

Material: Alloy Steels

.944 - 1.181	22	0.38	300 - 390	.006 - .010
1.141 - 1.574	27	0.47	320 - 420	.006 - .012
1.535 - 1.968	32	0.56	320 - 420	.008 - .012
1.929 - 4.015	42, 54, 68	0.75	320 - 420	.010 - .014
3.935 - 20.00	85, 100, 200	0.84	320 - 420	.012 - .016
	300, 400, 500		320 - 420	.012 - .016

Material: Stainless Steels

.944 - 1.181	22	0.38	200 - 300	.005 - .008
1.141 - 1.574	27	0.47	220 - 320	.006 - .010
1.535 - 1.968	32	0.56	220 - 320	.006 - .010
1.929 - 4.015	42, 54, 68	0.75	220 - 320	.008 - .012
3.935 - 20.00	85, 100, 200	0.84	220 - 320	.010 - .014
	300, 400, 500		220 - 320	.010 - .014

Material: Cast Iron

.944 - 1.181	22	0.38	200 - 350	.008 - .012
1.141 - 1.574	27	0.47	220 - 350	.010 - .014
1.535 - 1.968	32	0.56	220 - 350	.010 - .014
1.929 - 4.015	42, 54, 68	0.75	220 - 350	.012 - .016
3.935 - 20.00	85, 100, 200	0.84	220 - 350	.012 - .018
	300, 400, 500		220 - 350	.012 - .018

Material: Aluminum and Aluminum Alloys

.944 - 1.181	22	0.38	400 - 1000	.008 - .012
1.141 - 1.574	27	0.47	500 - 1200	.010 - .014
1.535 - 1.968	32	0.56	500 - 1200	.010 - .014
1.929 - 4.015	42, 54, 68	0.75	500 - 1200	.012 - .016
3.935 - 20.00	85, 100, 200	0.84	500 - 1200	.012 - .018
	300, 400, 500		500 - 1200	.012 - .018

Material: Titanium and High Temperature Alloys

.944 - 1.181	22	0.25	90 - 120	.005 - .008
1.141 - 1.574	27	0.32	100 - 130	.006 - .010
1.535 - 1.968	32	0.38	100 - 130	.006 - .010
1.929 - 4.015	42, 54, 68	0.50	100 - 130	.008 - .012
3.935 - 20.00	85, 100, 200	0.56	100 - 130	.008 - .014
	300, 400, 500		100 - 130	.008 - .014

Finish Boring with Single Inserts

Material: Plain Carbon Steel

Dia. Range (inch)	Head Size	Max. Stock Removal on Dia.	Suggested Speeds SFM	Suggested Feeds IPR
.944 - 1.181	22	.004 - .024	350 - 450	.002 - .006
1.141 - 1.574	27	.004 - .024	380 - 500	.002 - .006
1.535 - 1.968	32	.005 - .030	380 - 500	.002 - .006
1.929 - 4.015	42, 54, 68	.005 - .030	380 - 500	.004 - .008
3.935 - 20.00	85, 100, 200	.006 - .040	380 - 500	.004 - .008
	300, 400, 500	.006 - .040	380 - 500	.004 - .008

Material: Alloy Steels

.944 - 1.181	22	.004 - .024	320 - 420	.002 - .006
1.141 - 1.574	27	.004 - .024	350 - 450	.002 - .006
1.535 - 1.968	32	.005 - .030	350 - 480	.002 - .006
1.929 - 4.015	42, 54, 68	.005 - .030	350 - 480	.004 - .008
3.935 - 20.00	85, 100, 200	.006 - .040	350 - 480	.004 - .008
	300, 400, 500	.006 - .040	350 - 480	.004 - .008

Material: Stainless Steels

.944 - 1.181	22	.010 - .030	220 - 320	.003 - .006
1.141 - 1.574	27	.010 - .030	250 - 350	.003 - .006
1.535 - 1.968	32	.015 - .040	250 - 350	.003 - .006
1.929 - 4.015	42, 54, 68	.015 - .040	250 - 350	.004 - .008
3.935 - 20.00	85, 100, 200	.020 - .050	250 - 350	.005 - .008
	300, 400, 500	.020 - .050	250 - 350	.005 - .008

Material: Cast Iron

.944 - 1.181	22	.010 - .030	220 - 350	.003 - .006
1.141 - 1.574	27	.010 - .030	250 - 380	.003 - .006
1.535 - 1.968	32	.015 - .040	250 - 380	.003 - .006
1.929 - 4.015	42, 54, 68	.015 - .040	250 - 380	.005 - .008
3.935 - 20.00	85, 100, 200	.020 - .050	250 - 380	.005 - .008
	300, 400, 500	.020 - .050	250 - 380	.005 - .008

Material: Aluminum and Aluminum Alloys

.944 - 1.181	22	.010 - .030	500 - 1000	.002 - .006
1.141 - 1.574	27	.010 - .030	500 - 1200	.004 - .008
1.535 - 1.968	32	.015 - .040	500 - 1200	.004 - .008
1.929 - 4.015	42, 54, 68	.015 - .040	500 - 1200	.004 - .008
3.935 - 20.00	85, 100, 200	.020 - .050	500 - 1200	.004 - .010
	300, 400, 500	.020 - .050	500 - 1200	.004 - .010

Material: Titanium and High Temperature Alloys

.944 - 1.181	22	.010 - .030	100 - 130	.003 - .006
1.141 - 1.574	27	.010 - .030	100 - 150	.003 - .006
1.535 - 1.968	32	.015 - .040	100 - 150	.003 - .006
1.929 - 4.015	42, 54, 68	.015 - .040	100 - 150	.004 - .008
3.935 - 20.00	85, 100, 200	.020 - .050	100 - 150	.004 - .008
	300, 400, 500	.020 - .050	100 - 150	.004 - .008

Parts for Rough Heads

Indexable cartridges and insert screws are on page 168.

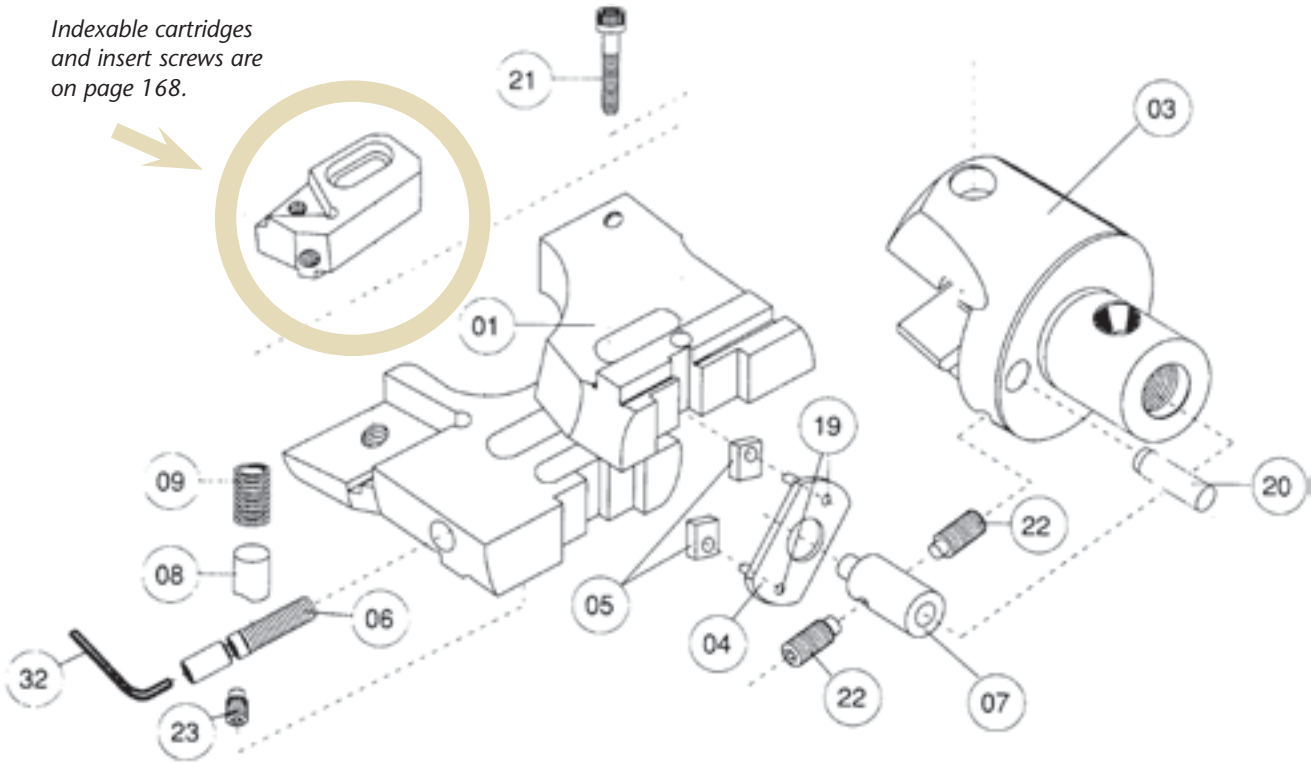

Rough Boring Heads - Integral Pocket

Boring Heads	01	03	04	05	06	07	08	09	19	20	21	22	23
D 22.75___	D22.75.01.---	D22 03	D22 04		D22 06	D22 07	D22 08	D22 09	D22 19	D22 20	D22 21	D22 22	D22 23
D 22.90___	D22.90.01.---	D22 03	D22 04		D22 06	D22 07	D22 08	D22 09	D22 19	D22 20	D22 21	D22 22	D22 23
D 27.75___	D27.75.01.---	D27 03	D27 04		D27 06	D22 07	D22 08	D27 09	D22 19	D27 20	D27 21	D27 22	D27 23
D 27.90___	D27.90.01.---	D27 03	D27 04		D27 06	D22 07	D22 08	D27 09	D22 19	D27 20	D27 21	D27 22	D27 23
D 32.75___W	D32.75.01.---	D32 03W	D32 04		D32 06	D32 07	D32 08	D32 09	D32 19	D32 20	D32 21	D32 22	D32 23
D 32.90___W	D32.90.01.---	D32 03W	D32 04		D32 06	D32 07	D32 08	D32 09	D32 19	D32 20	D32 21	D32 22	D32 23
D 42.75___	D42.75.01.---	D42 03	D42 04	D42 05	D42 06	D42 07	D42 08	D42 09	D22 20	D42 20	D42 21	D42 22	D42 23
D 42.90___	D42.90.01.---	D42 03	D42 04	D42 05	D42 06	D42 07	D42 08	D42 09	D22 20	D42 20	D42 21	D42 22	D42 23
D 54.75___	D54.75.01.---	D54 03	D54 04	D42 05	D54 06	D54 07	D54 08	D42 09	D22 20	D54 20	D54 21	D54 22	D42 23
D 54.90___	D54.90.01.---	D54 03	D54 04	D42 05	D54 06	D54 07	D54 08	D42 09	D22 20	D54 20	D54 21	D54 22	D42 23

Rough Boring Heads - Cartridge Type

Boring Heads	01	03	04	05	06	07	08	09	19	20	21	22	23
D 68.2CT___	D68 01 2CT	D68 03	D68 04	D68 05	D68 06	D68 07	D68 08	D68 09	D68 19	D68 20	D68 21	D68 22	D68 23
D 85.3CT___	D85 01 3CT	D85 03	D85 04	D85 05	D85 06	D85 07	D85 08	D85 09	D85 19	D85 20	D85 21	D85 22	D85 23
D 100.3CT___	D100 01 3CT	D100 03	D100 04	D85 05	D100 06	D100 07	D100 08	D85 09	D85 19	D100 20	D100 21	D85 22	D85 23
D 200.3CT___	D200 01 3CT	D200 03	D100 04	D85 05	D200 06	D100 07	D100 08	D85 09	D85 19	D100 20	D100 21	D85 22	D85 23

Parts for Large Rough Heads

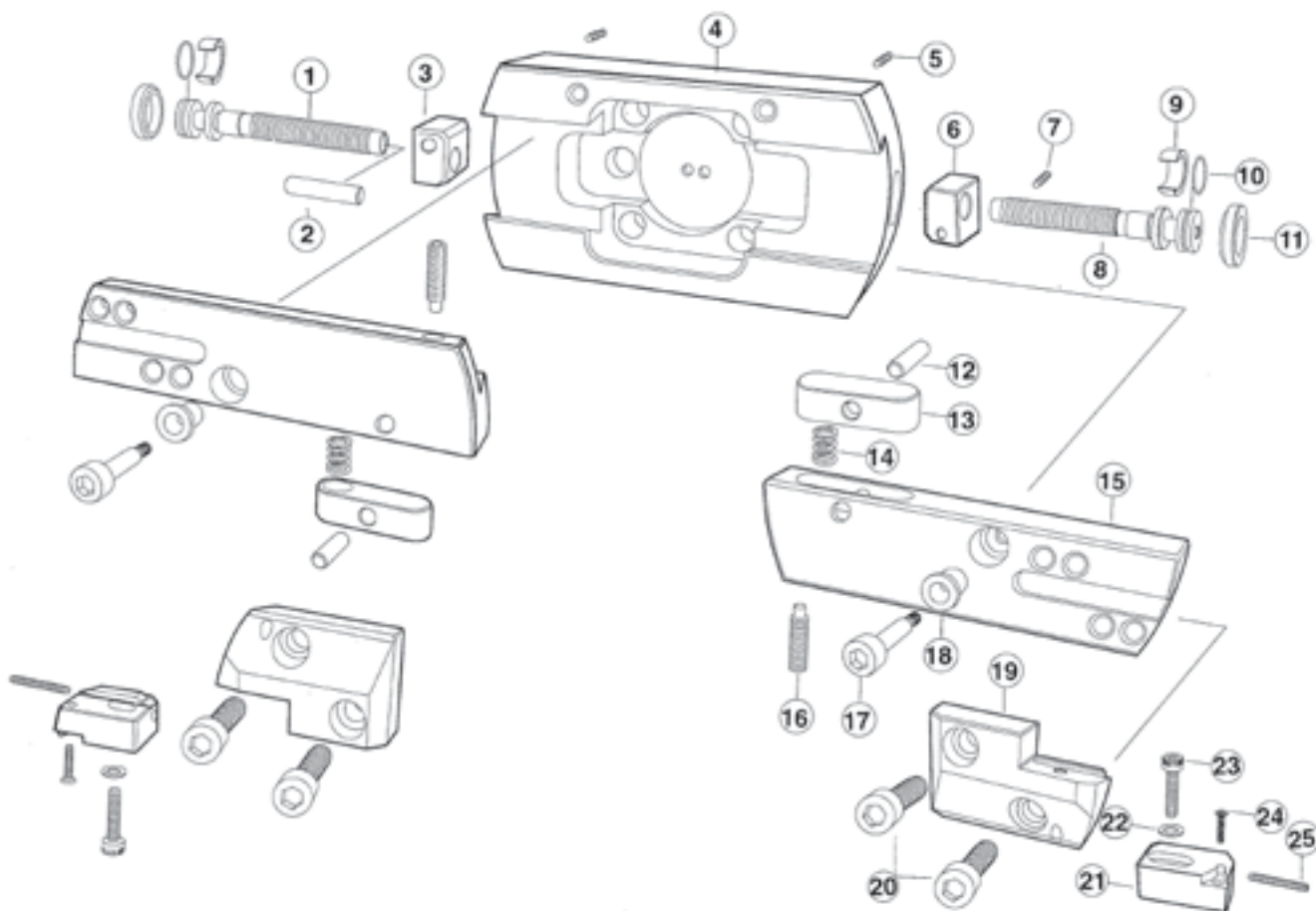

Large Rough Boring Heads

Spare Part	Rough Head Reference Number		
	D 300W	D 400W	D 500W
1	D300.51W	D400.51W	D500.51W
2	D300.69	D300.69	D300.69
3	D300.55I	D300.55I	D300.55I
4	D300.03	D400.03	D500.03
5	D68.23	D68.23	D68.23
6	D300.54D	D300.54D	D300.54D
7	D300.68	D300.68	D300.68
8	D300.50DW	D400.50DW	D500.50DW
9	A68.16	A68.16	A68.16
10	A68.25	A68.25	A68.25
11	A68.15	A68.15	A68.15
12	D300.60	D300.60	D300.60
13	D300.56	D300.56	D300.56

Spare Part	Rough Head Reference Number		
	D 300W	D 400W	D 500W
14	D300.59	D300.59	D300.59
15	D300.001	D400.001	D500.001
16	D300.58	D300.58	D300.58
17	D300.57	D300.57	D300.57
18	D300.62	D300.62	D300.62
19	D300.49	D300.49	D300.49
20	D300.61	D300.61	D300.61
21	3CT._____	3CT._____	3CT._____
22	D68.28	D68.28	D68.28
23	D85.27	D85.27	D85.27
24	TT_____	TT_____	TT_____
25	D85.29	D85.29	D85.29

Parts for Finish Heads

Indexable cartridges and insert screws are on page 88.

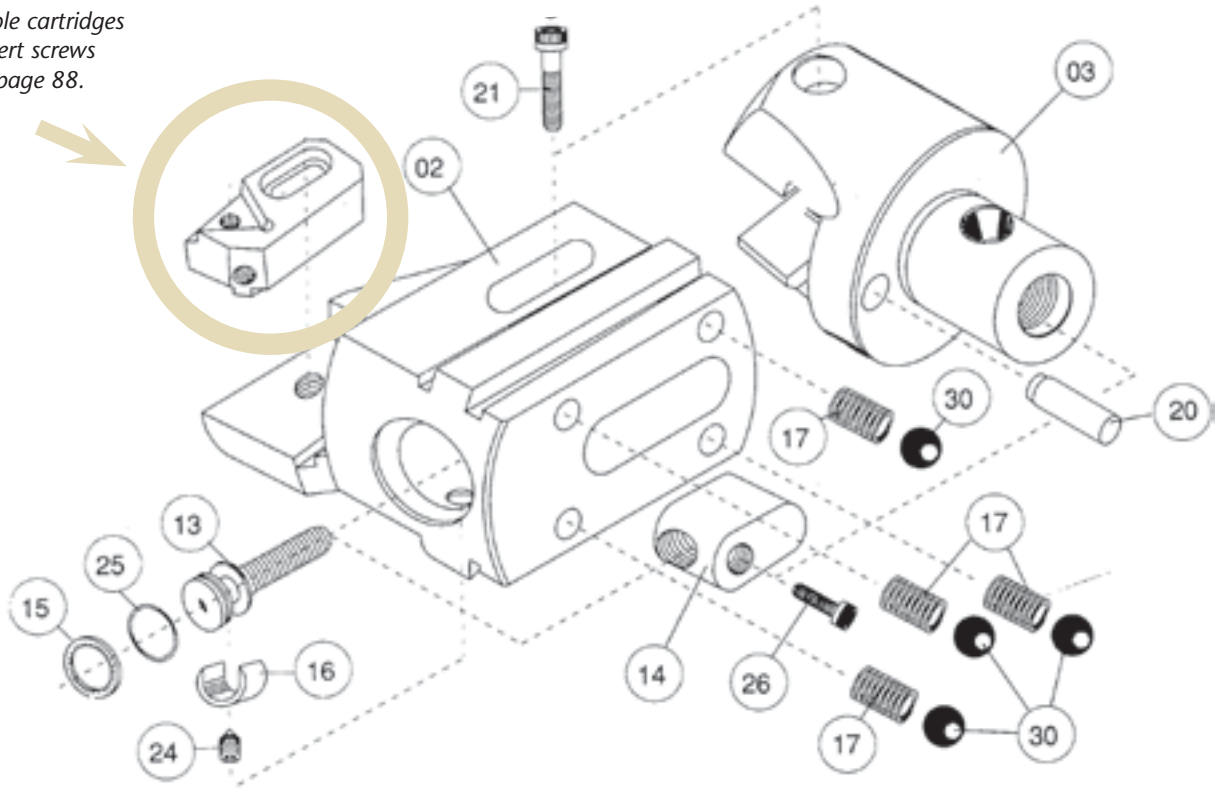

Finish boring heads - Integral Pocket

Boring Head	02	03	13	14	15	16	17	20	21	25	26	30
A 22.75__W	A22.75.02__	A22 03	A22 13W	A22 14W	A22 15W	A22 16	A22 17	D22 20	D22 21	A22 25	A22 26	A22 30
A 22.90__W	A22.90.02__	A22 03	A22 13W	A22 14W	A22 15W	A22 16	A22 17	D22 20	D22 21	A22 25	A22 26	A22 30
A 27.75__W	A27.75.02__	A27 03	A27 13W	A22 14W	A22 15W	A22 16	A27 17	D27 20	D27 21	A22 25	A27 26	A27 30
A 27.90__W	A27.90.02__	A27 03	A27 13W	A22 14W	A22 15W	A22 16	A27 17	D27 20	D27 21	A22 25	A27 26	A27 30
A 32.75__W	A32.75.02__	A32 03W	A32 13W	A32 14W	A32 15W	A32 16	A27 17	D32 20	D32 21	A22 25	A32 26	A27 30
A 32.90__W	A32.90.02__	A32 03W	A32 13W	A32 14W	A32 15W	A32 16	A27 17	D32 20	D32 21	A22 25	A32 26	A27 30
A 42.75__W	A42.75.02__	A42 03	A42 13W	A42 14W	A42 15W	A42 16	A42 17	D42 20	D42 21	A42 25	A42 26	A42 30
A 42.90__W	A42.90.02__	A42 03	A42 13W	A42 14W	A42 15W	A42 16	A42 17	D42 20	D42 21	A42 25	A42 26	A42 30
A 54.75__W	A54.75.02__	A54 03	A54 13W	A54 14W	A42 15W	A42 16	D54 09	D54 20	D54 21	A42 25	A42 26	A54 30

Finish boring heads - Cartridge Type

Boring Head	02	03	13	14	15	16	17	20	21	25	26	30
A 68.2CT__W	A68 02 2CT	A68 03	A68 13W	A68 14W	A68 15W	A68 16	A68 17	D68 20	D68 21	A68 25	A68 26	A68 30
A 85.3CT__W	A85 02 3CT	A85 03	A85 13W	A85 14W	A85 15W	A85 16	D85 09	D85 20	D85 21	A85 25	A85 26	A85 30
A 100.3CT__W	A100 02 3CT	A100 03	A85 13W	A85 14W	A85 15W	A85 16	D85 09	D100 20	D100 21	A85 25	A85 26	A85 30
A 200.3CT__W	A200 02 3CT	A200 03	A200 13W	A85 14W	A85 15W	A85 16	D85 09	D100 20	D100 21	A85 25	A85 26	A85 30

Parts for Large Finish Heads

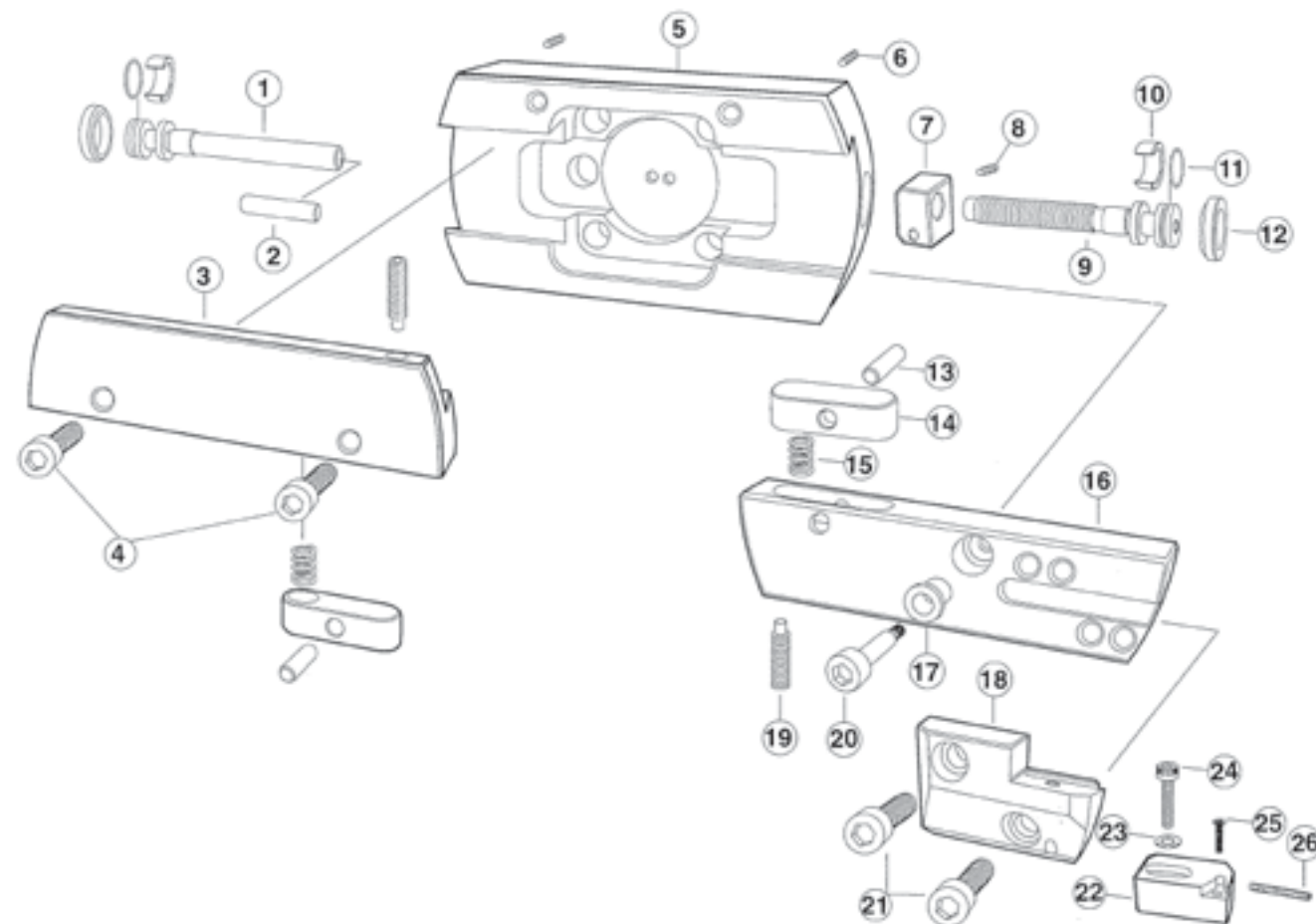

Large Finish Boring Heads

Spare Part	Finish Head Reference Number		
	A 300W	A 400W	A 500W
1	A300.52N	A400.52N	A500.52N
2	D 300.69	D 300.69	D 300.69
3	A 300.002	A400.002	A500.002
4	A300.68	A300.68	A300.68
5	D300.03	D400.03	D500.03
6	D68.23	D68.23	D68.23
7	D300.54D	D300.54D	D300.54D
8	D300.68	D300.68	D300.68
9	D300.50DW	D400.50DW	D500.50DW
10	A68.16	A68.16	A68.16
11	A68.25	A68.25	A68.25
12	A68.15	A68.15	A68.15
13	D300.60	D300.60	D300.60

Spare Part	Finish Head Reference Number		
	A 300W	A 400W	A 500W
14	D300.56	D300.56	D300.56
15	D300.59	D300.59	D300.59
16	D300.001	D400.001	D500.001
17	D300.62	D300.62	D300.62
18	D300.49	D300.49	D300.49
19	D300.58	D300.58	D300.58
20	D300.57	D300.57	D300.57
21	D300.61	D300.61	D300.61
22	3CT.____	3CT.____	3CT.____
23	D68.28	D68.28	D68.28
24	D85.27	D85.27	D85.27
25	TT_____	TT_____	TT_____
26	D85.29	D85.29	D85.29

Measurement Guide for Special Order Toolholders

V-flange CNC machine
make, model and spindle

v-flange tool #1 dimensions

D = _____
 F = _____
 W = _____
 A = _____
 N = _____

v-flange tool #2 dimensions

D = _____
 F = _____
 W = _____
 A = _____
 N = _____

HSK CNC machine
make, model and spindle

HSK tool #1 dimensions

D = _____
 F = _____
 W = _____
 A = _____
 N = _____

HSK tool #2 dimensions

D = _____
 F = _____
 W = _____
 A = _____
 N = _____

Fill in all the required dimensions (left).
Then, fax or phone in your order for a fast quote.

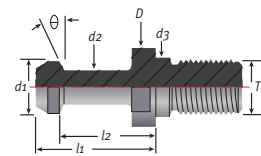
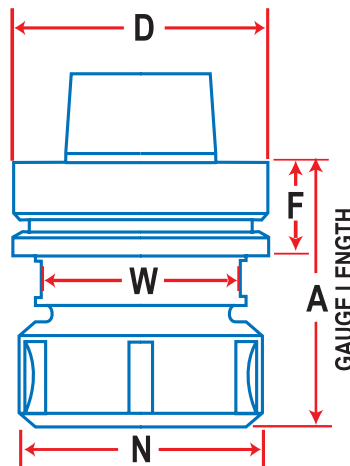
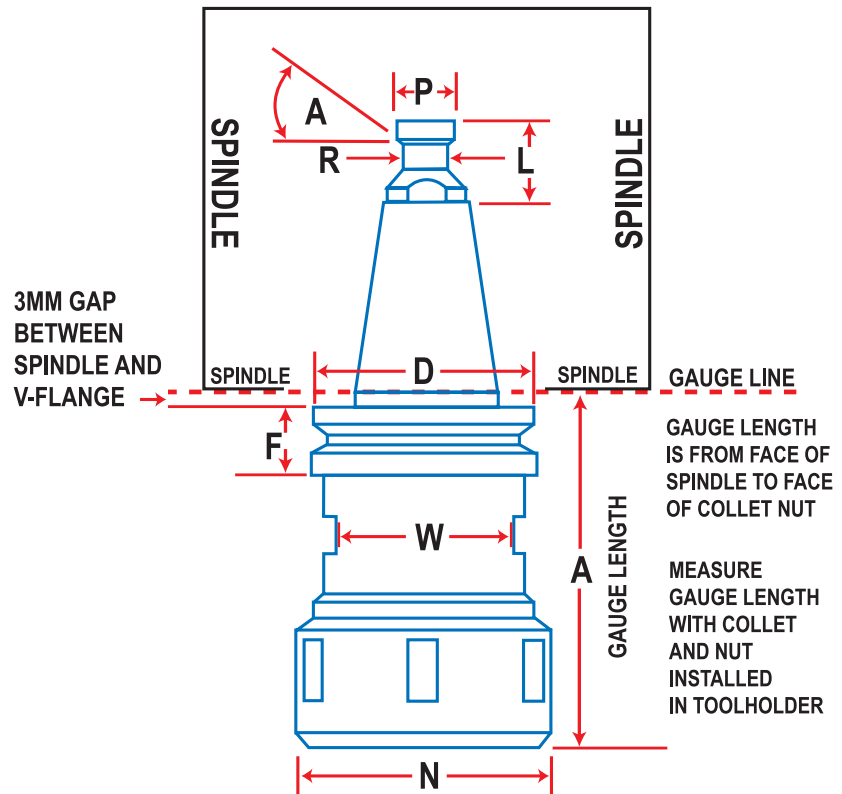

For special order retention
knobs call (800) 597-3921

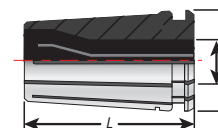

For special order collets
call (800) 597-3921

New! Capto-Compatible* Tools – C4, C5, C6

The same great Techniks Certified toolholders you are used to... now Capto-Compatible*



ER Collet Chucks

- *Balanced 25,000*
- *See page 192*

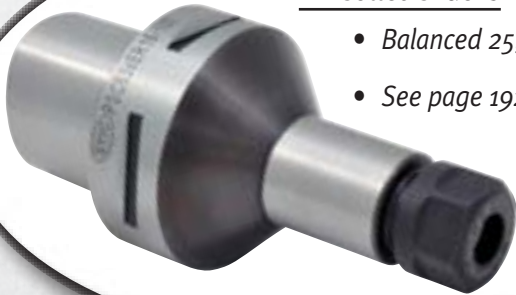

End Mill Holders

- *H5 precision bore*
- *See page 193*



SlimFIT Holders

- *Nose diameter .55"*
- *See page 195*



ShrinkFIT

- *.0001" T.I.R.*
- *See page 194*



Face Mill Arbors

- *H6 arbor spec*
- *See page 196*



Turning Tools

- *External turning*
- *See page 197*



Built for Speed.

*Compatible with the Capto tool system. Techniks products are not affiliated with or endorsed by Sandvik AB.

Capto-Compatible* C4, C5, C6

Capto-Compatible* C4, C5, C6 ER Collet Chucks



Techniks certified for accuracy & balance.
Inspection report comes with each holder.

Features

- Balanced to 25,000 RPM at G2.5
- T.I.R. 0.0001" or better
- PowerCOAT Nut included – 75% greater clamping power

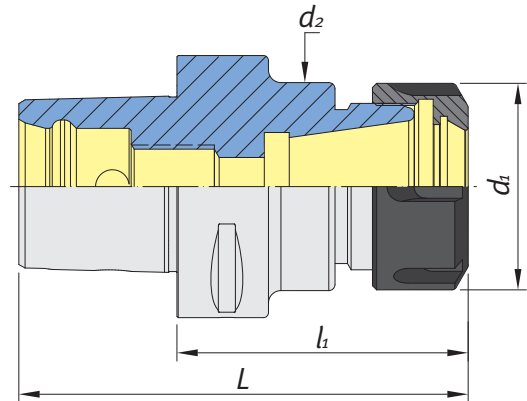

Capto-Compatible* C4 ER Collet Chucks

Part No.	Description	L	l1	d1	d2	Size Range
141.122.16.070	Capto C4 x ER16–70mm	94mm	70mm	28mm	28mm	1.0–10.0mm
141.122.25.052	Capto C4 x ER25–52mm	76mm	52mm	42mm	42mm	1.0–16.0mm
141.122.32.054	Capto C4 x ER32–54mm	78mm	54mm	50mm	50mm	2.0–20.0mm

Capto-Compatible* C5 ER Collet Chucks

Part No.	Description	L	l1	d1	d2	Size Range
142.122.16.100	Capto C5 x ER16–100mm	130mm	100mm	28mm	28mm	1.0–10.0mm
142.122.25.055	Capto C5 x ER25–55mm	82mm	55mm	42mm	42mm	1.0–16.0mm
142.122.32.057	Capto C5 x ER 32–57mm	84mm	57mm	50mm	50mm	2.0–20mm

Capto-Compatible* C6 ER Collet Chucks

Part No.	Description	L	l1	d1	d2	Size Range
143.122.16.100	Capto C6 x ER16–100mm	138mm	100mm	28mm	28mm	1.0–10.0mm
143.122.25.060	Capto C6 x ER25–60mm	98mm	60mm	42mm	42mm	1.0–160mm
143.122.32.070	Capto C6 x ER32–70mm	108mm	70mm	50mm	50mm	2.0–20.0mm
143.122.40.065	Capto C6 x ER40–65mm	103mm	65mm	63mm	63mm	3.0–26.0mm
143.123.08.600	Capto C6 x ER8M–6"	190mm	6"	12mm	16mm	0.5–5.0mm
143.123.11.600	Capto C6 x ER11M–6"	190mm	6"	19mm	20mm	0.5–7.0mm
143.123.16.600	Capto C6 x ER16M–6"	190mm	6"	22mm	25mm	1.0–10.0mm
143.123.20.600	Capto C6 x ER20M–6"	190mm	6"	28mm	32mm	2.0–16.0mm

*Compatible with the Capto tool system. Techniks products are not affiliated with or endorsed by Sandvik AB.

Capto-Compatible* C4 & C6 Endmill Holders



Techniks certified for H5 bore accuracy.
Inspection report comes with each holder.

Features

- High precision bore (H5) is best in the industry
- Extends cutting tool life
- Balanced to 10,000 RPM at G2.5

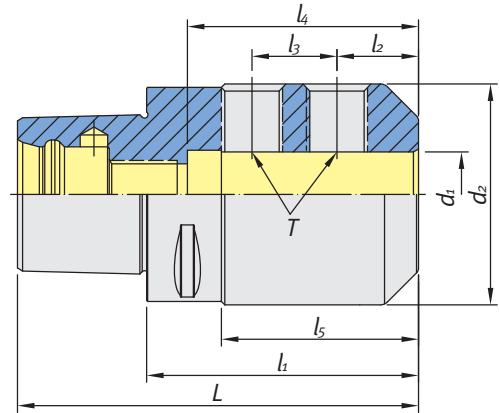

Capto-Compatible* C4, C5, C6

Techniks H5 Bore Tolerance Extends Tool Life 60%

You lose 10% of cutting tool life for every .0001" of T.I.R.

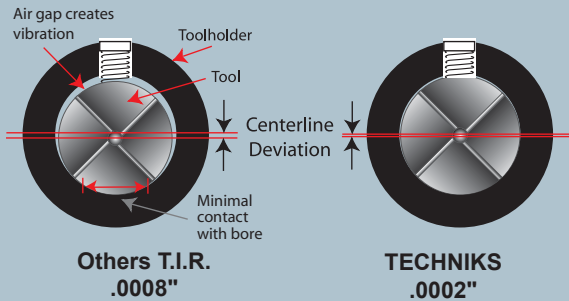

Capto-Compatible* C4 Endmill Holders

Part No.	Description	L	I1	I2	I4	I5	d1	d2	T
141.653.54.197	Capto C4 x SLN 1/4"-1.97"	2.91"	1.97"	0.63"	1.38"	1"	0.25"	0.78"	1/4-28"
141.653.55.197	Capto C4 x SLN 5/16"-1.97"	2.91"	1.97"	0.63"	1.38"	1.02"	0.3125"	0.88"	5/16-24"
141.653.56.197	Capto C4 x SLN 3/8"-1.97"	2.91"	1.97"	0.75"	1.535"	1.08"	0.375"	1"	3/8-24"
141.653.58.217	Capto C4 x SLN 1/2"-2.17"	3.11"	2.17"	0.875"	1.732"	1.42"	0.5"	1.25"	7/16-20"
141.653.61.217	Capto C4 x SLN 5/8"-2.17"	3.11"	2.17"	0.875"	1.732"	1.54"	0.625"	1.5"	7/16-20"

Capto-Compatible* C6 Endmill Holders

Part No.	Description	L	I1	I2	I3	I4	I5	d1	d2	T
143.653.54.217	Capto C6 x SLN 1/4"-2.17"	3.66"	2.17"	0.63"	-	1.38"	0.984"	0.25"	0.78"	1/4-28"
143.653.55.217	Capto C6 x SLN 5/16"-2.17"	3.66"	2.17"	0.63"	-	1.38"	1.024"	0.3125"	0.88"	5/16-24"
143.653.56.236	Capto C6 x SLN 3/8"-2.36"	3.86"	2.36"	0.75"	-	1.535"	1.181"	0.375"	1"	3/8-24"
143.653.58.236	Capto C6 x SLN 1/2"-2.36"	3.86"	2.36"	0.875"	-	1.732"	1.299"	0.5"	1.25"	7/16-20"
143.653.61.256	Capto C6 x SLN 5/8"-2.56"	4.06"	2.56"	0.937"	-	1.732"	1.398"	0.625"	1.5"	1/2-20"
143.653.64.256	Capto C6 x SLN 3/4"-2.56"	4.06"	2.56"	1"	-	1.929"	1.476"	0.75"	1.75"	5/8-18"
143.653.68.315	Capto C6 x SLN 1" -3.15"	4.65"	3.15"	1.125"	1"	2.559"	2.283"	1"	2"	3/4-16"

*Compatible with the Capto tool system. Techniks products are not affiliated with or endorsed by Sandvik AB.



All Techniks products are backed by our 100% satisfaction guarantee!

Capto-Compatible* C4, C5, C6 ShrinkFIT Chucks



Techniks certified for accuracy & balance.
Inspection report comes with each holder.

Features

- Maximum T.I.R. only 0.0001"
- Balanced to 25,000 RPM at G2.5
- Superior rigidity and holding power

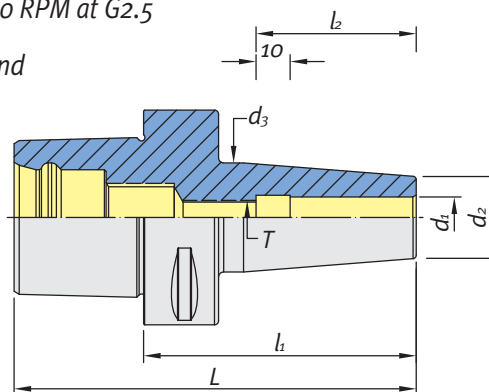

Capto-Compatible* C4 ShrinkFIT Chucks

Part No.	Description	L	l1	l2	d1	d2	d3	T
141.651.54.295	Capto C4 x SF 1/4"-2.95"	3.9"	2.95"	1.41"	0.3125"	0.83"	1.06"	M5 x 0.8P
141.651.55.295	Capto C4 x SF 5/16"-2.95"	3.9"	2.95"	1.41"	0.3125"	0.83"	1.06"	M6 x 1.0P
141.651.56.295	Capto C4 x SF 3/8"-2.95"	3.9"	2.95"	1.61"	0.375"	0.95"	1.26"	M8 x 1.25P
141.651.58.295	Capto C4 x SF 1/2"-2.95"	3.9"	2.95"	1.81"	0.5"	1.10"	1.34"	M10 x 1.5P
141.651.61.315	Capto C4 x SF 5/8"-3.15"	4.09"	3.15"	1.93"	0.625"	1.06"	1.34"	M12 x 1.75P

Capto-Compatible* C5 ShrinkFIT Chucks

Part No.	Description	L	l1	l2	d1	d2	d3	T
142.651.52.315	Capto C5 x SF 1/8"-80mm	110mm	80mm	38mm	1/8"	16mm	22mm	M6 x 1.0P
142.651.53.315	Capto C5 x SF 3/16"-80mm	110mm	80mm	38mm	3/16"	16mm	22mm	M6 x 1.0P
142.651.54.315	Capto C5 x SF 1/4"-80mm	110mm	80mm	38mm	1/4"	21mm	27mm	M5 x 0.8P
142.651.56.315	Capto C5 x SF 3/8"-80mm	110mm	80mm	51mm	3/8"	24mm	32mm	M8 x 1.25P
142.651.58.315	Capto C5 x SF 1/2"-80mm	110mm	80mm	38mm	1/2"	28mm	34mm	M10 x 1.5P
142.651.61.315	Capto C5 x SF 5/8"-80mm	110mm	80mm	44.5mm	5/8"	27mm	34mm	M12 x 1.75P
142.651.64.315	Capto C5 x SF 3/4"-80mm	110mm	80mm	38mm	3/4"	36mm	42mm	M16 x 2.0P

Capto-Compatible* C6 ShrinkFIT Chucks

Part No.	Description	L	l1	l2	d1	d2	d3	T
143.651.52.300	Capto C6 x SF 1/8"-3"	4.50"	3"	1.77"	0.125"	0.36"	0.64"	M6 x 1.0P
143.651.53.300	Capto C6 x SF 3/16"-3"	4.50"	3"	1.77"	0.137"	0.43"	0.70"	M6 x 1.0P
143.651.54.315	Capto C6 x SF 1/4"-3.15"	4.65"	3.15"	1.41"	0.3125"	0.83"	1.06"	M5 x 0.8P
143.651.55.315	Capto C6 x SF 5/16"-3.15"	4.65"	3.15"	1.41"	0.3125"	0.83"	1.06"	M6 x 1.0P
143.651.56.315	Capto C6 x SF 3/8"-3.15"	4.65"	3.15"	1.61"	0.375"	0.95"	1.26"	M8 x 1.25P
143.651.58.315	Capto C6 x SF 1/2"-3.15"	4.65"	3.15"	1.81"	0.5"	1.10"	1.34"	M10 x 1.5P
143.651.61.335	Capto C6 x SF 5/8"-3.35"	4.84"	3.35"	1.93"	0.625"	1.06"	1.34"	M12 x 1.75P
143.651.64.335	Capto C6 x SF 3/4"-3.35"	4.84"	3.35"	2"	0.75"	1.26"	1.65"	M16 x 2.0P
143.651.68.354	Capto C6 x SF 1"-3.54"	5.04"	3.54"	2.24"	1"	1.73"	2.08"	M16 x 2.0P
143.651.72.374	Capto C6 x SF 1-1/4"-3.74"	5.24"	3.74"	2.4"	1.25"	1.73"	2.08"	M16 x 2.0P

*Compatible with the Capto tool system. Techniks products are not affiliated with or endorsed by Sandvik AB.

Capto-Compatible* C4 & C6 SlimFIT Collet Chucks



Internal drawbar collet eliminates need for clamping nut to permit narrow nose diameter. 4° collet provides greater holding power and improved accuracy.



Coolant-thru design

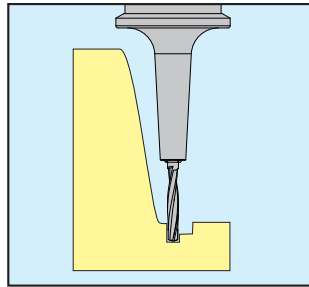

Maximum nose clearance

Features

- Maximum T.I.R. 0.0001"
- Balanced to 25,000 RPM at G2.5
- Nose diameter only .55"
- Use with SlimFIT collets for shank sizes 3/32" - 1/4"



Collet Set

Part No.	Description
18743-12IMS	SlimFIT 6 - 12 pc. set

1/8" - 1/4" by 64ths (except no 5/32 or 7/32) 3mm - 6mm by 1mm

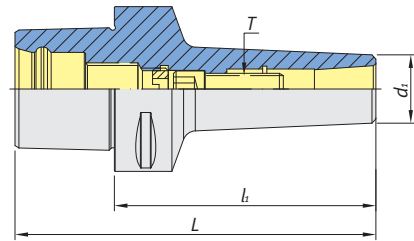

Capto-Compatible* C4 & C6 SlimFIT Collet Chucks

Part No.	Description	L	l1	d1	Size Range
141.648.06.075	Capto C4 x SBL 6-75mm	94mm	75mm	.55"	3-6mm
143.648.06.080	Capto C6 x SBL6 -80mm	118mm	80mm	.55"	3-6mm

Features

- Use with any toolholder
- Extremely accurate drawbar collet
- Use with SlimFIT 6 collets

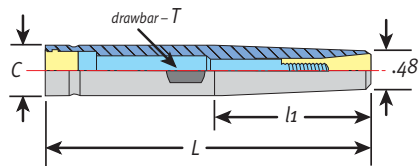

SlimFIT Extensions

Part No.	Description	L	l1	C
06032-3	1/2" x OLP6-3" extension	3"	1.89"	.50"
06032	1/2" x OLP6-5" extension	5"	1.89"	.50"
06034	1/2" x OLP6-6" extension	6"	1.89"	.50"
06038	5/8" x OLP6-5" extension	5"	1.89"	.625"
06040	5/8" x OLP6-6" extension	6"	1.89"	.625"
06042	5/8" x OLP6-8" extension	8"	1.89"	.625"

SlimFIT Inch Size Collets

Part No.	Description
18851-3/32	SlimFIT 6 - 3/32" collet
18851-7/64	SlimFIT 6 - 7/64" collet
18851-1/8	SlimFIT 6 - 1/8" collet
18851-9/64	SlimFIT 6 - 9/64" collet
18851-5/32	SlimFIT 6 - 5/32" collet
18851-11/64	SlimFIT 6 - 11/64" collet
18851-3/16	SlimFIT 6 - 3/16" collet
18851-13/64	SlimFIT 6 - 13/64" collet
18851-7/32	SlimFIT 6 - 7/32" collet
18851-15/64	SlimFIT 6 - 15/64" collet
18851-1/4	SlimFIT 6 - 1/4" collet

SlimFIT Metric Size Collets

Part No.	Description
18851-03	SlimFIT 6 - 3mm collet
18851-04	SlimFIT 6 - 4mm collet
18851-05	SlimFIT 6 - 5mm collet
18851-05.5	SlimFIT 6 - 5.5mm collet
18851-06	SlimFIT 6 - 6mm collet

*Compatible with the Capto tool system. Techniks products are not affiliated with or endorsed by Sandvik AB.



All Techniks products are backed by our 100% satisfaction guarantee!

Capto-Compatible* C4, C5, C6 Face Mill Arbors



Features

- H6 arbor tolerance for less chatter and better tool life
- Compatible with all coolant-thru face mills
- Each arbor is lab certified for accuracy

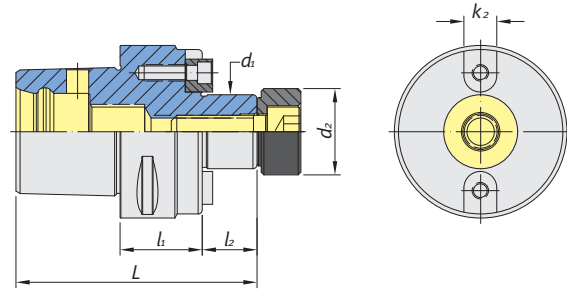

Capto-Compatible* C4, C5, C6 Face Mill Arbors

Part No.	Description	L	l1	l2	d1	d2	k2
141.151.64.100	Capto C4 x FMA 3/4"-1"	3.13"	1"	0.687"	3/4"	0.88"	0.314"
142.151.68.157	Capto C5 x FMA 1"-1.57"	3.43"	1.57"	0.687"	1"	1.24"	0.375"
143.151.64.100	Capto C6 x FMA 3/4"-1"	3.18"	1"	0.687"	3/4"	0.88"	0.314"
143.151.68.200	Capto C6 x FMA 1"-2"	4.18"	2"	0.687"	1"	1.24"	0.375"
143.151.72.200	Capto C6 x FMA 1-1/4"-2"	4.18"	2"	0.687"	1.25"	1.614"	0.5"

CoolBLAST Coolant Option

- Use with Techniks face mill arbors
- Compatible with all coolant thru face mills
- For coolant up to 1,500 PSI

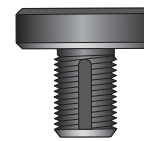

CoolBLAST arbor screw provides coolant path.

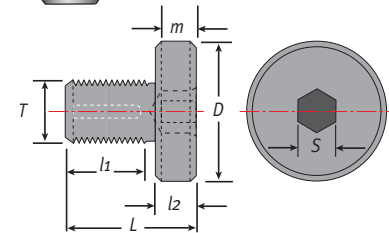

CoolBLAST Coolant Arbor Screws

Part No.	Description	Style	Arbor Size	D	L	l1	l2	T	S	m
WF.C1-0.75	CoolBLAST arbor screw 3/4"	B	3/4"	7/8"	1.8"	1.4"	.37"	3/8"-24UNF	1/4"	.197"
9851125	CAS-A-0.75 Smaller "D"	A	3/4"	5/8"	1.375"	1.0"	.36"	3/8-24 UNF	1/4"	.37"
WF.C1-1	CoolBLAST arbor screw 1.0"	B	1.0"	1-3/16"	1.4"	0.81"	.37"	1/2"-20UNF	5/16"	.197"
9851135	CAS-A-1.00Smaller "D"	A	1.0"	1.180"	1.375"	1.0"	.38"	1/2-20UNF	5/16"	.37"
WF.C1-1.25	CoolBLAST arbor screw 1-1/4"	B	1-1/4"	1-1/2"	1.44"	0.94"	.5"	5/8"-18UNF	5/16"	.236"

Standard Arbor Screws

Part No.	Description	Arbor Size	D	L	l1	l2	T	S	m
WF0.75	FMA screw 3/4"	3/4"	7/8"	1.8"	1.4"	.37"	3/8"-24UNF	1/4"	.197"
WF1	FMA screw 1.0"	1.0"	1-3/16"	1.4"	0.81"	.37"	1/2"-20UNF	5/16"	.197"
WF1.25	FMA screw 1-1/4"	1-1/4"	1-1/2"	1.44"	0.94"	.5"	5/8"-18UNF	5/16"	.236"

*Compatible with the Capto tool system. Techniks products are not affiliated with or endorsed by Sandvik AB.

Capto-Compatible* C6 External Turning Tools



Features

- High accuracy for best repeatability
- Turning, boring, threading and grooving
- Uses high-performance inserts. See pg. 251



LAMINA
TECHNOLOGIES

HIGH-PERFORMANCE
3x the Thickness of Conventional PVD!

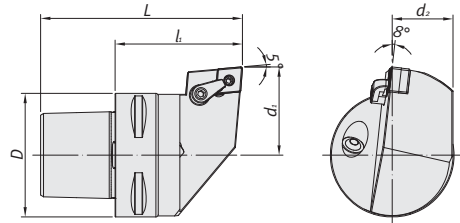

Capto-Compatible* C6 MCLN

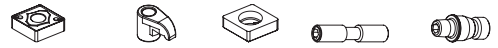

Part No.	Description	L	l1	D	d1	d2	Insert	Clamp	Shim	Screw	Lock Pin
143.475.12L.065	Capto C6-MCLNL-DX12	103	65	63	45	31	CN_43_	MC620	CMS432	MS630	MLP46-A
143.475.12R.065	Capto C6-MCLNR-DX12	103	65	63	45	31	CN_43_	MC620	CMS432	MS630	MLP46-A

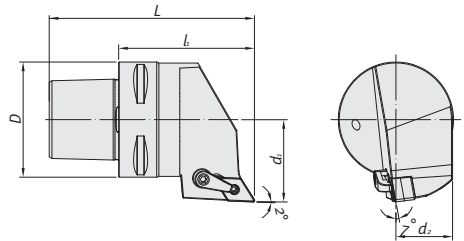

Capto-Compatible* C6 MDJN

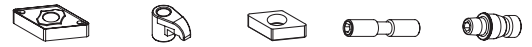

Part No.	Description	L	l1	D	d1	d2	Insert	Clamp	Shim	Screw	Lock Pin
143.476.15L.075	Capto C6-MDJNL-EX15	113	75	63	45	31	DN_43_	MC622	DMS442	MS630	MLP46L-A
143.476.15R.075	Capto C6-MDJNR-EX15	113	75	63	45	31	DN_43_	MC622	DMS442	MS630	MLP46L-A

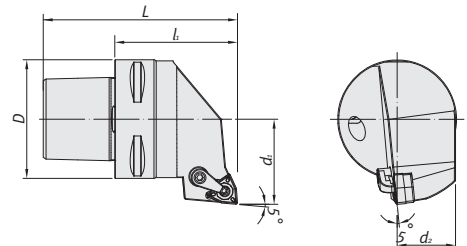

Capto-Compatible* C6 MWLN



Part No.	Description	L	l1	D	d1	d2	Insert	Clamp	Shim	Screw	Lock Pin
143.478.08L.065	Capto C6-MWLN-DX08	103	65	63	45	31	WN_43_	MC620	TMS432	MS630	MLP46L-A
143.478.08R.065	Capto C6-MWLN-DX08	103	65	63	45	31	WN_43_	MC620	TMS432	MS630	MLP46L-A

*Compatible with the Capto tool system. Techniks products are not affiliated with or endorsed by Sandvik AB.



All Techniks products are backed by our 100% satisfaction guarantee!

Capto-Compatible* C6 External Turning Tools



Features

- High accuracy for best repeatability
- Turning, boring, threading and grooving
- Uses high-performance inserts. See pg. 251



LAMINA
TECHNOLOGIES

HIGH-PERFORMANCE
3x the Thickness of Conventional PVD!

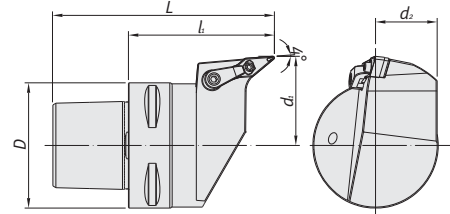

Capto-Compatible* C6 MVLN

Part No.	Description	L	l1	D	d1	d2	Insert	Clamp	Shim	Screw	Screw
143.479.16L.075	Capto C6-MVLNL-EX16	113	75	63	45	31	VN_33_	MC622	VMS322	MS630	MLP34L-A
143.479.16R.075	Capto C6-MVLNR-EX16	113	75	63	45	31	VN_33_	MC622	VMS322	MS630	MLP34L-A

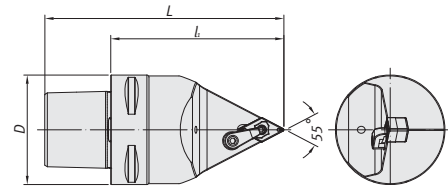

Capto-Compatible* C6 MDNN

Part No.	Description	L	l1	D	Insert	Clamp	Shim	Screw	Screw
143.481.15N.100	Capto C6-MDNNN-H15	138	100	63	DN_43_	MC622	DMS442	MS625	MLP46L-A

Capto-Compatible* C4, C5, C6

*Compatible with the Capto tool system. Techniks products are not affiliated with or endorsed by Sandvik AB.

Precision Retention Knobs and Setup Equipment



Retention Knobs

- All mating surfaces are precision ground
- Manufactured to the highest standards for maximum safety and long life

Tightening Fixtures

- Preset tools offline to save machine time
- For CAT, BT, HSK, ISO tapers
- Change retention knobs from below



Torque Wrenches and Adapters

*You lose 10% of tool life for every .0001" of T.I.R.
Always torque your retention knobs and collets to
proper torque for best performance and tool life.*

Built for Speed.

CAT40, 50 Precision Retention Knobs

Techniks Retention Knobs

- All mating surfaces precision ground
- Manufactured to the highest standards for maximum safety and long life
- Hardened for maximum longevity

Please make sure that the Retention Knob you order is the correct one for your machine. Using the wrong Retention Knob can cause damage to your machine spindle, the toolholder, and may create a safety hazard.

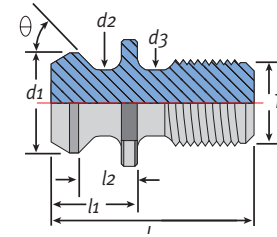

ANSI Style

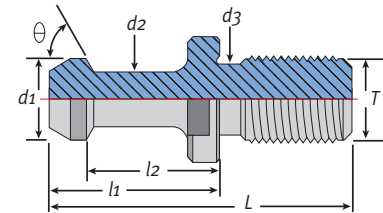

MAS Style



CAT Retention Knobs

Part No.	Type	θ	d1	d2	d3	L	l1	l2	T
21006-15	CAT40-DIN	15°	.75"	0.55"	0.640"	1.88"	1.024"	.787"	5/8 - 11"
21007-15	CAT40-DIN	15°	.75"	0.55"	-	1.89"	1.028"	.792"	5/8 - 11"
21003	CAT40-ANSI	45°	0.740"	0.490"	0.490"	1.50"	0.640"	.440"	5/8 - 11"
21003-45	CAT40-MAS-I	45°	0.590"	0.394"	0.512"	2.25"	1.266"	.990"	5/8 - 11"
21003-60	CAT40-MAS-II	60°	0.590"	0.394"	0.512"	2.25"	1.266"	.990"	5/8 - 11"
21003-90	CAT40-MAS-III	90°	0.590"	0.394"	0.512"	2.25"	1.266"	.990"	5/8 - 11"
21005-45	CAT50-MAS-I	45°	0.906"	0.669"	0.827"	3.346"	1.772"	1.378"	1 - 8"
21005-60	CAT50-MAS-II	60°	0.906"	0.669"	0.827"	3.346"	1.772"	1.378"	1 - 8"
21005-90	CAT50-MAS-III	90°	0.906"	0.669"	0.827"	3.346"	1.772"	1.378"	1 - 8"
21008-15	CAT50-DIN	15°	1.101"	0.825"	-	2.640"	1.338"	.984"	1 - 8"
21005	CAT50-ANSI	45°	1.140"	0.820"	0.820"	2.30"	1.00"	.700"	1 - 8"

CAT Coolant Style Retention Knobs

Part No.	Type	θ	d1	d2	d3	L	l1	l2	T
21006-15C	CAT40-DIN Coolant	15°	.75"	0.55"	0.640"	1.88"	1.024"	.787"	5/8 - 11"
21007-15C	CAT40-DIN Coolant	15°	.75"	0.55"	-	1.89"	1.028"	.792"	5/8 - 11"
21003-C	CAT40-ANSI-C	45°	0.740"	0.490"	0.490"	1.50"	0.640"	.440"	5/8 - 11"
21003-45C	CAT40-Coolant-I	45°	0.590"	0.394"	0.512"	2.25"	1.266"	.990"	5/8 - 11"
21003-60C	CAT40-Coolant-II	60°	0.590"	0.394"	0.512"	2.25"	1.266"	.990"	5/8 - 11"
21003-90C	CAT40-Coolant-III	90°	0.590"	0.394"	0.512"	2.25"	1.266"	.990"	5/8 - 11"
21003-45CSF	CAT40-Coolant-I SlimFIT	45°	0.590"	0.394"	0.512"	2.25"	1.266"	.990"	5/8 - 11"
21003-60CSF	CAT40-Coolant-II SlimFIT	60°	0.590"	0.394"	0.512"	2.25"	1.266"	.990"	5/8 - 11"
21003-90CSF	CAT40-Coolant-III SlimFIT	90°	0.590"	0.394"	0.512"	2.25"	1.266"	.990"	5/8 - 11"
21005-45C	CAT50-Coolant-I	45°	0.906"	0.669"	0.827"	3.346"	1.772"	1.378"	1 - 8"
21005-60C	CAT50-Coolant-II	60°	0.906"	0.669"	0.827"	3.346"	1.772"	1.378"	1 - 8"
21005-90C	CAT50-Coolant-III	90°	0.906"	0.669"	0.827"	3.346"	1.772"	1.378"	1 - 8"
21008-15C	CAT50-DIN Coolant	15°	1.101"	0.825"	-	2.640"	1.338"	.984"	1 - 8"
21005-C	CAT50-ANSI-C	45°	1.140"	0.820"	0.820"	2.30"	1.00"	.700"	1 - 8"

BT Retention Knobs



Techniks Retention Knobs

- All mating surfaces precision ground
- Manufactured to the highest standards for maximum safety and long life
- Hardened for maximum longevity

Please make sure that the Retention Knob you order is the correct one for your machine. Using the wrong Retention Knob can cause damage to your machine spindle, the toolholder, and may create a safety hazard.

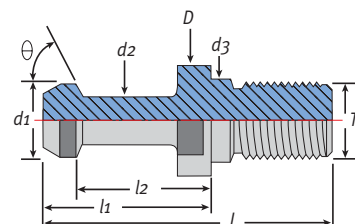

BT Retention Knobs

Dimensions in millimeters.

Part No.	Description	θ	D	d1	d2	d3	L	l1	l2	T
17801	BT30 - 45°	45°	16.5	11	7	12.5	43	23	18	M12
17803	BT40 - 45°	45°	23	15	10	17	60	35	28	M16
17834	BT40, ANSI, metric thread	45°	23	18.8	12.5	12.4	38	16	11	M16
17805	BT50 - 45°	45°	38	23	17	25	85	45	35	M24
17806	BT30 - 60°	60°	16.5	11	7	12.5	43	23	18	M12
17808	BT40 - 60°	60°	23	15	10	17	60	35	28	M16
17810	BT50 - 60°	60°	38	23	17	25	85	45	35	M24
17812	BT30 - 90°	60°	16.5	11	7	12.5	43	23	8	M12
17814	BT40 - 90°	60°	23	15	10	17	60	35	28	M16
17816	BT50 - 90°	60°	38	23	17	25	85	45	35	M24

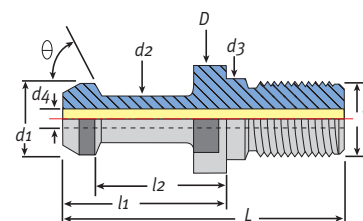

BT Coolant Style Retention Knobs

Dimensions in millimeters.

Part No.	Description	θ	D	d1	d2	d3	d4	L	l1	l2	T
17817	BT30 - 45° coolant	45°	16.5	11	7	12.5	4	43	23	18	M12
17836	BT40, ANSI, metric, coolant	45°	-	18.8	12.5	12.5	6.8	38	16	11	M16
17818	BT40 - 45° coolant	45°	23	15	10	17	4	60	35	28	M16
17820	BT40 - 60° coolant	60°	23	15	10	17	4	60	35	28	M16
17822	BT40 - 90° coolant	90°	23	15	10	17	4	60	35	28	M16
17824	BT50 - 45° coolant	45°	38	23	17	25	5	85	45	35	M24
17826	BT50 - 60° coolant	60°	38	23	17	25	5	85	45	35	M24
17828	BT50 - 90° coolant	90°	38	23	17	25	5	85	45	35	M24

DIN 69871 A & B Retention Knobs – Solid Pre-set Screws



Techniks Retention Knobs

- All mating surfaces precision ground
- Manufactured to the highest standards for maximum safety and long life
- Hardened for maximum longevity

Please make sure that the Retention Knob you order is the correct one for your machine. Using the wrong Retention Knob can cause damage to your machine spindle, the toolholder, and may create a safety hazard.

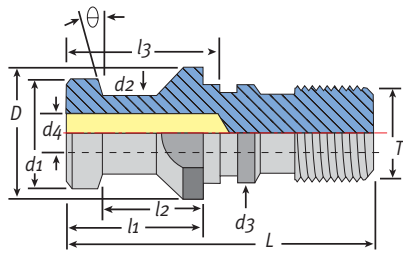

DIN 69871B

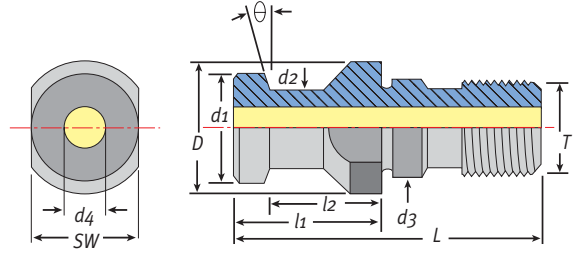

DIN 69871A

DIN 69871 A and B Style Retention Knobs

Dimensions in millimeters.

Part No.	Description	θ	D	d1	d2	d3	d4	L	l1	l2	l3	SW	T
49001	DAT30-A	15°	17	13	9	13	-	44	24	19	-	14	M12
49003	DAT40-A	15°	23	19	14	17	7	54	26	20	-	19	M16
49005	DAT50-A	15°	36	28	21	25	11.5	74	34	25	-	30	M24
49011	DAT30-B	15°	17	13	9	13	-	44	24	19	2.3	14	M12
49013	DAT40-B	15°	23	19	14	17	7	54	26	20	3.0	19	M16
49015	DAT50-B	15°	36	28	21	25	11.5	74	34	25	4.5	30	M24

Retention Knobs for CNC Routers



- All mating surfaces precision ground
- Manufactured to the highest standards for maximum safety and long life
- Hardened for maximum longevity

Match the dimensions and appearance of your retention knob to the drawings below. Use the manufacturer's print that came with your machine to verify your selection.

For safe operation, make sure that the pull stud you order is the exact pull stud your machine uses. Using the wrong pull stud can cause damage to the spindle and/or toolholder, and is a safety hazard.

HSD Spindles

Part No. 49019
(for HSD spindles)
Includes: Biesse, Bermag, Bussellato, CNT, DMS, CR Onsrud, Masterwood, Thermwood, and Holz-her

ISO30 Spindles

Part No. 49001-45
(Colombo ISO30 ball style for RS spindles) Includes: Motion Master (verify on manufacturer's print)

Part No. 13001
(for Colombo ISO30 billet spindle) Includes: Motion Master, Anderson (for newer machines, verify on manufacturer's print)

DAT Spindles

Part No. 13003
(DAT 40) (verify on manufacturer's print)

BT Spindles

Part No. 07801
(BT30 - 45°)
Includes: Heian, Shinx

Part No. 07806
(BT30 - 60°) Includes: Shoda, Anderson (1997 and earlier, verify on manufacturer's print)

Part No. 750-19
(BT30 KOMO)
Only for BT30 KOMO routers

Part No. 07812
(BT30 - 90°)
(verify on manufacturer's print)

Part No. 4403502
(BT35 - 60°)
(Heian, verify on manufacturer's print)

Hand Wrenches for Collet Nuts



DNA slotted wrench



ER hex wrench



ER slotted wrench



ER mini wrench



TG hook wrench

Note: Correct torque on the collet nut reduces collet wear and improves safety by properly securing cutting tool in the holder. Use the torque chart on page 72 for tightening collet nuts. Do not over-tighten nuts or you may damage the collet and/or toolholder.

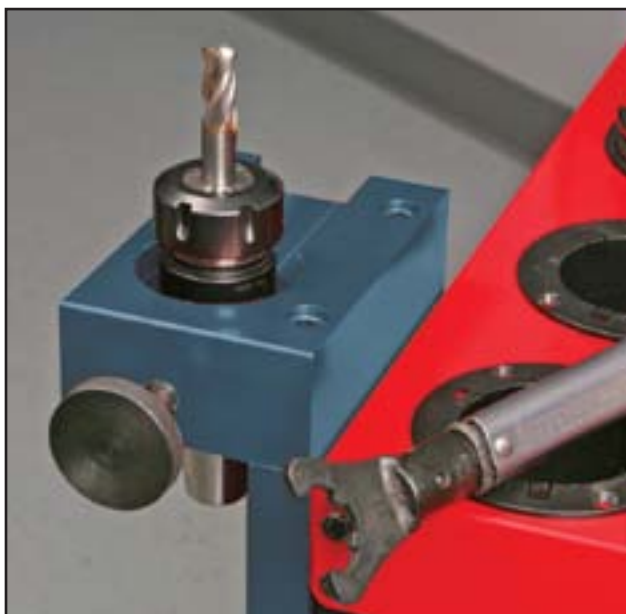

Use a tightening fixture to secure the toolholder. (pg. 206)

DNA Hand Wrenches

Part No.	Description	Nut Type
DNA11W	DNA 11 wrench	DNA-11
DNA16W	DNA 16 wrench	DNA-16
DNA20W	DNA 20 wrench	DNA-20
DNA32W	DNA 32 wrench	DNA-32
894-22	DNA mini nut wrench	DNA-Mini

ER Hex Hand Wrenches

Part No.	Description	Nut Type
894-36	TE-Short wrench	TE Short
04608	ER11-A wrench	A (Hex)
04609	ER16-A wrench	A (Hex)
04610	ER20-A wrench	A (Hex)

ER Slotted Hand Wrenches

Part No.	Description	Nut Type
04613	ER16-E wrench	Slotted
04614	ER20-E wrench	Slotted
04615	ER25-E wrench	Slotted
04616	ER32-E wrench	Slotted
04617	ER40-E wrench	Slotted
04618	ER50-E wrench	Slotted

ER Mini Hand Wrenches

Part No.	Description	Nut Type
04620	ER8-M wrench	ER Mini
04621	ER11-M wrench	ER Mini
04622	ER16-M wrench	ER Mini
04623	ER20-M wrench	ER Mini
04624	ER25-M wrench	ER Mini

Hook Style TG Hand Wrenches

Part No.	Description	Nut Type
04018	TG 75 wrench	TG 75
03691	TG 100 wrench	TG 100
22220	SYOZ 20 wrench	SYOZ 20
01250-13S	Drill Chuck wrench	Chuck

Adjustable Torque Wrenches and Collet Key Adapters



Torque Wrench Features

- Provides proper tightening for cutting tool life
- Easy read dial for fast adjustments to torque value
- Prevent tool accidents



Set adjustable dial to specified torque and tighten nut until wrench "clicks".

Torque values given in tables on this page.

Adjustable Torque Wrench

Part No.	Range	Length	Weight	Spigot
60TH	5-45 ft/lbs	12"	1 lb.	16mm round
200TH	30-150 ft/lbs	16.5"	1.75 lbs	16mm round
300TH	45-228 ft/lbs	21.5"	2.5 lbs	16mm round



ER25 Mini



TG Hook



DNA 16 Slotted



ER Hex



ER Slotted

ER Mini Collet Key Adapters

Part No.	Size	Type	Torque
04576	ER11 mini	mini	12 ft/lbs
04577	ER16 mini	mini	20 ft/lbs
04578	ER20 mini	mini	22 ft/lbs
04587	ER25 mini	mini	28 ft/lbs

ER Hex Collet Key Adapters

Part No.	Size	Type	Torque
04601-16	ER16 hex	hex	42 ft/lbs
04602-20	ER20 hex	hex	59 ft/lbs

Hook Collet Key Adapters

Part No.	Size	Type	Torque
04604-32	TG 75	slotted	90 ft/lbs
03690-25	TG 100/SYOZ 25	hook	90 ft/lbs
SYOZ20-TWA	SYOZ-20	hook	40 ft/lbs

ER Slotted Collet Key Adapters

Part No.	Size	Type	Torque
DNA11TWA	DNA 11	slotted	12 ft/lbs
DNA16TWA	DNA 16	slotted	42 ft/lbs
DNA20TWA	DNA 20	slotted	59 ft/lbs
DNA32TWA	DNA 32	slotted	100 ft/lbs
04580-16	ER16 slotted	slotted	42 ft/lbs
04580-20	ER20 slotted	slotted	59 ft/lbs
04603-25	ER25 slotted	slotted	77 ft/lbs
04604-32	ER32 slotted	slotted	100 ft/lbs
04605-40	ER40 slotted	slotted	130 ft/lbs

Retention Knob Sockets – Square Drive



Part No.	Size	Flats	Drive	Torque
PSS-30BT	BT30	0.535"	3/8"	36 ft/lbs
PSS-30ISO	ISO 30	0.535"	3/8"	36 ft/lbs
PSS-40	All 40 taper	0.750"	3/8"	76 ft/lbs
PSC-50	CAT50, BT50	1.187"	1/2"	100 ft/lbs

Fixed Head Square Drives

Part No.	Description	Drive
29828	3/8" square drive	3/8"
29827	1/2" square drive	1/2"



Tightening Fixtures For CAT, BT, HSK, and ISO Spindles



A sliding collar engages the wrench flats on HSK and toolholders without drive slots.

NTS Side Mount Fixtures

- For CAT, BT, HSK, ISO spindles
- Change knobs from bottom
- Bolts right to workbench



A large set-screw engages the drive slot in BT and CAT holders.

40 Taper and BT30 NTS Fixtures

Part No.	Description
NTS-40-TAPER	Any CAT40 or BT40 taper
NTS-BT30-38	BT30 taper - 38mm flats
NTS-BT30-41	BT30 taper - 41mm flats
NTS-BT30-SLOT	BT30 for drive slots

HSK63 NTS Fixtures

Part No.	Description
NTS-HSK63A	HSK63A - no flats
NTS-HSK63F-36	HSK63F - 36mm flats
NTS-HSK63F-38	HSK63F - 38mm flats
NTS-HSK63F-41	HSK63F - 41mm flats
NTS-HSK63F-46	HSK63F - 46mm flats

ISO NTS Fixtures

Part No.	Description
NTS-ISO20-17	ISO 20 - 17mm flats
NTS-ISO20-22	ISO 20 - 22mm flats
NTS-ISO25-27	ISO 25 - 27mm flats
NTS-ISO30-36	ISO 30 - 36mm flats
NTS-ISO30-38	ISO 30 - 38mm flats
NTS-ISO30-47	ISO 30 - 47mm flats

Top or Side Mount Fixtures

- For CAT, BT, HSK, spindles
- Change knobs from bottom
- Bolts right to workbench



BT, CAT style

HSK style

Top or Side Mount Fixtures

Part No.	Description
17883	BT30, CAT 30
07884	BT40, CAT40
07885	BT50, CAT50
17893	HSK63A, 63B, 63D



Benchtop Mount Fixtures

- For CAT, BT spindles
- Bolts right to workbench

Benchtop Mount for CAT & BT

Part No.	Description
07852	BT30
07854	BT40
07856	BT50
07870	CAT40
07872	CAT50

Spindle Wipers – Analog and Touch Lamp Preset Gauges



Spindle Wipers

- For CAT, BT, HSK spindles
- Remove contaminants from spindles and holders

Part No.	Taper
17706	30
17707	40
17708	50
38036	HSK63A
38032	HSK63F

Real lambskin provides the best cleaning. Use with any type of machine with a taper of 7/24 CAT, BT or DIN 69871.



Analog Axial Preset Gauge Features

- Accuracy 0.0002"
- Easy to measure tool depth
- Height 50mm

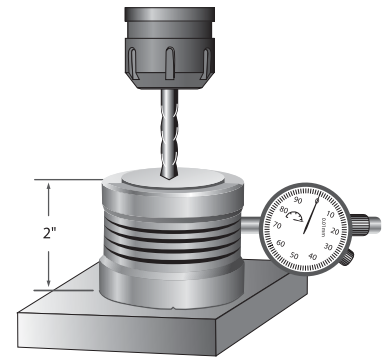
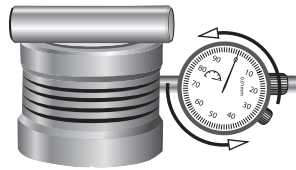

Analog Axial Preset Gauge

Part No.	Description
17906-2	ZSI-50 preset gauge
17906-04	replacement dial

1. Use the gauge pin included to press down on the spring-loaded center piece as illustrated. Please be sure the gauge pin is placed on the shiny surface.
2. Turn the indicator to read "0", then remove the gauge pin.

3. Put the unit on the workpiece and carefully jog the tool down to make contact with the gauge face. When the gauge reads "0" the tool is 2" above the workpiece.



Touch Lamp Axial Preset Gauge Features

- Accuracy .0002"
- 360° red lamp lights up when touched
- Height 2" (50mm)
- Magnetic base (use vertically or horizontally)

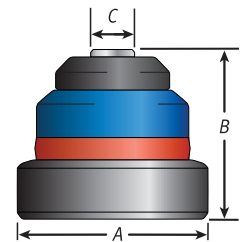

Instructions

1. Check height of unit with a gauge block and dial indicator. Turn allen screw on the side of the unit if adjustment is needed.
2. Do not use calipers for presetting unit, only use gauge block.
3. Move the cutting tool tip towards the sensor button until the unit lights up, then reverse direction until the light goes off.
4. When presetting diameter, rotate tool slowly for higher precision.

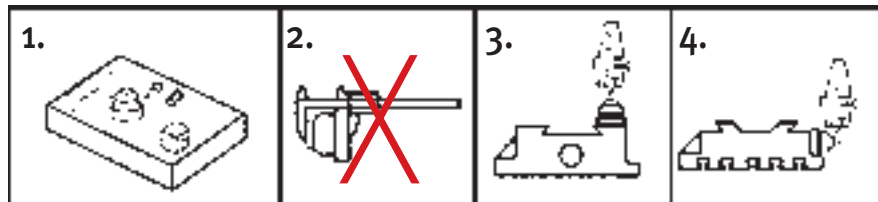

Touch Lamp Axial Preset Gauge

Part No.	Description	A	B	C
07905-2	ZOP-50 Gauge	56mm	50mm or 2"	13.5mm

Coolant-Thru Pre-Set Screws

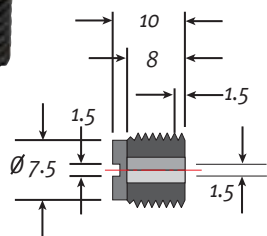

BD-TH-1031

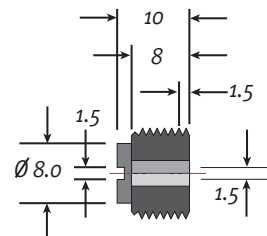

BD-TH-1062

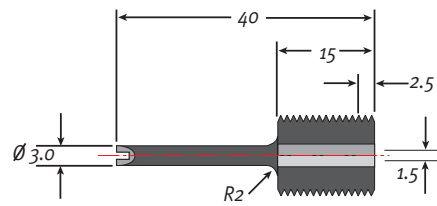

BD-TH-1063

Coolant Set Screws

Part No.	Description
BD-TH-1031	For M10 x 1.5 straight shank chuck with coolant – for small diameter tools
BD-TH-1062	For M12 x 1.75 straight shank chuck w/ coolant – for small diameter tools
BD-TH-1063	Long stop for M12 x 1.75 straight shank chuck w/coolant – for small diameter tools

Coolant Set Screws

Part No.	Description	M	L	d
16080C-20	Coolant Set Screw	M5 x 0.8P	20mm	2.5
16082C-20	Coolant Set Screw	M8 x 1.25P	20mm	4
16083C-20	Coolant Set Screw	M10 x 1.5P	20mm	4
16085C-20	Coolant Set Screw	M12 x 1.75P	20mm	4
16089C-20	Coolant Set Screw	M16 x 02.0P	20mm	5
16091C-20	Coolant Set Screw	M20 x 2.0P	20mm	5

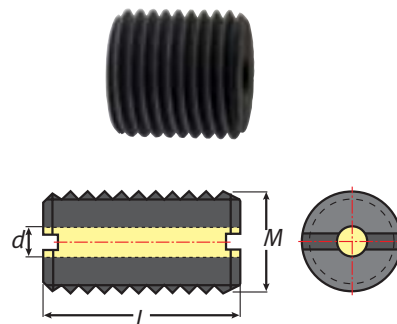

Solid Pre-set Screws for ER and TG Collet Chucks

Part No.	Description	Figure	Collet Series
16081	M 6 x 1.0 P - 15	1	ER11
16083	M 10 x 1.5 P - 15	1	ER16
16085	M 12 x 1.75 P - 15	1	ER20
16087	M 12 x 1.75 P - 25 (extended)	2	ER20
16088	M 8 x 1.25 P - 16	1	-
16089	M 16 x 2.0 P - 15	1	ER25 & 32, TG 75
16096	M 16 x 2.0 P - 50	-	-
16091	M 20 x 2.0 P - 15	1	ER40
16094	M 20 x 2.0 P - 50	-	-
16092	M20 x 2.0P - 100	-	-
16093	M 24 x 2.0 P - 15	1	ER50 & TG 100

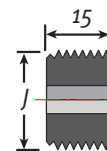

Figure 1

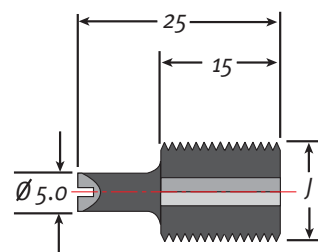

Figure 2

Solutions that are innovative, accurate, and simple.

Techniks Toolholders

- Minimize T.I.R.
- Maximize rigidity
- Increase tool life



Accurate

Lamina High-Performance

- Eliminate insert guesswork
- Minimize set up time
- Maximize machine time



Simplify

PowerLOC

- Eliminate milling chucks
- Minimize set up time
- Maximize machine time



ShrinkMILL

- Perfect ShrinkFIT connection
- 30% less runout
- Longer insert life



Innovative

**We're Making a Better Connection
Between the Cutting Tool and Spindle.**

Nexus ShrinkMILL and Face Mills

Attacking Heat & Vibration is in Our DNA.



We're Making a Better Connection Between the Cutting Tool and Spindle.

Nexus ShrinkMILL and Face Mills



Make more parts per day
and increase your profit margin!

Problem

- ❶ Poor I.D./O.D. tolerance between face mill and face mill arbor
- ❷ This causes high T.I.R. (runout) and high vibration while cutting due to uneven cutting from each insert
- ❸ High T.I.R. also causes premature wear on the arbor, causing even more vibration

Solution

- ❶ ShrinkMILL perfects the connection between face mill and arbor with ShrinkFIT technology
- ❷ We reduce the diameter of the face mill I.D. so it can be ShrinkFIT onto the arbor for the most rigid, powerful, and accurate connection in the industry
- ❸ Our face mills and arbors are made out of the same H13 tool steel as our regular ShrinkFIT holders so you get the same outstanding performance and insert life

Benefits

- ❶ Better surface finish
- ❷ Less scrap due to less premature failure of inserts
- ❸ Increased productivity

Nexus ShrinkMILL – Perfect ShrinkFIT Connection

T.I.R. Causes Vibration. Vibration Causes Poor Cutting and Premature Failure in Inserts.

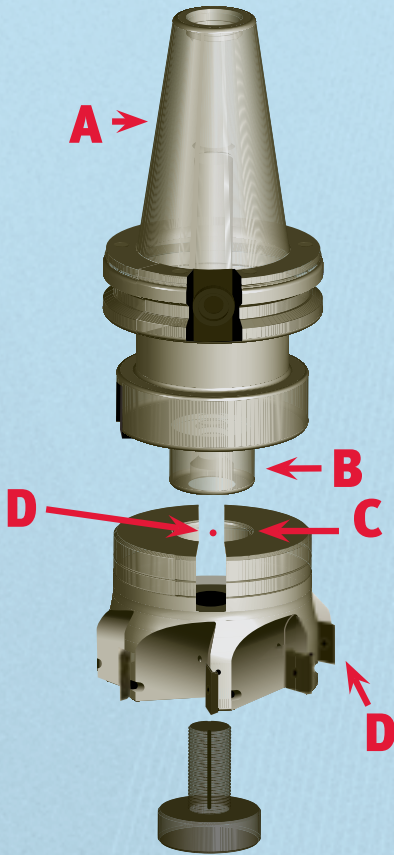

Typical 1" ID Face Mill Assembly

Measurement		Tolerance
A Taper to arbor T.I.R.	Toolholder =	0.0002"
B OD tolerance	Arbor =	-0.0008"
C ID tolerance	Face Mill ID =	+0.0008"
D ID to insert OD (including insert tolerance)	Face Mill ID/OD =	±0.003"
Total Tolerance =		0.0048" T.I.R.

Reduced vibration allows faster feeds & speeds, increasing parts per day, and reduces premature failure of inserts.

Use ShrinkMILL to reduce scrap—which is money!

ID/OD Tolerance in Face Mills

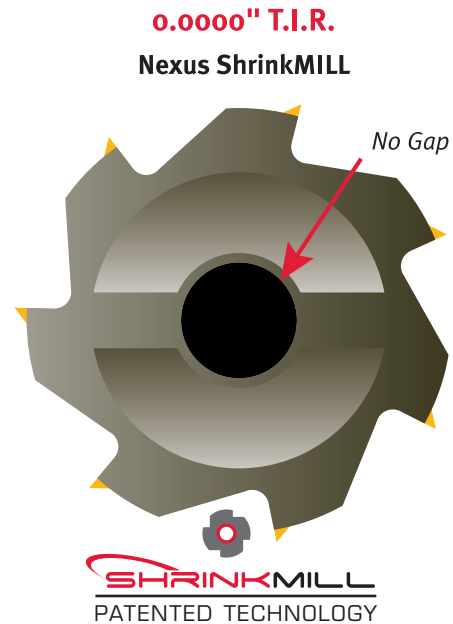
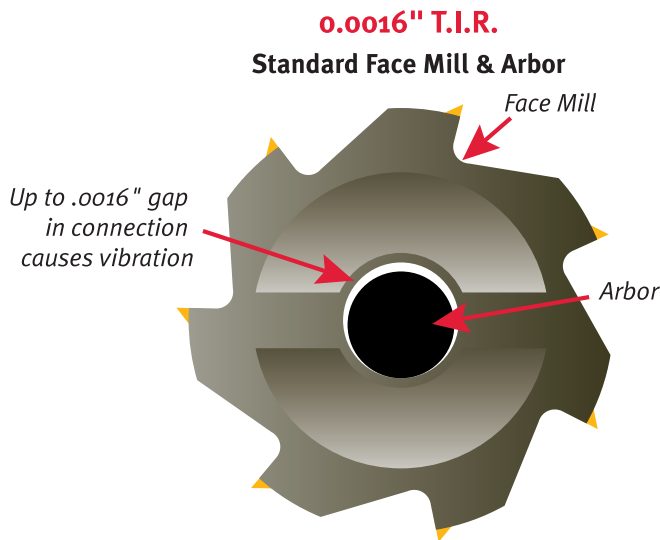

We're Making a Better Connection Between the Cutting Tool and Spindle.

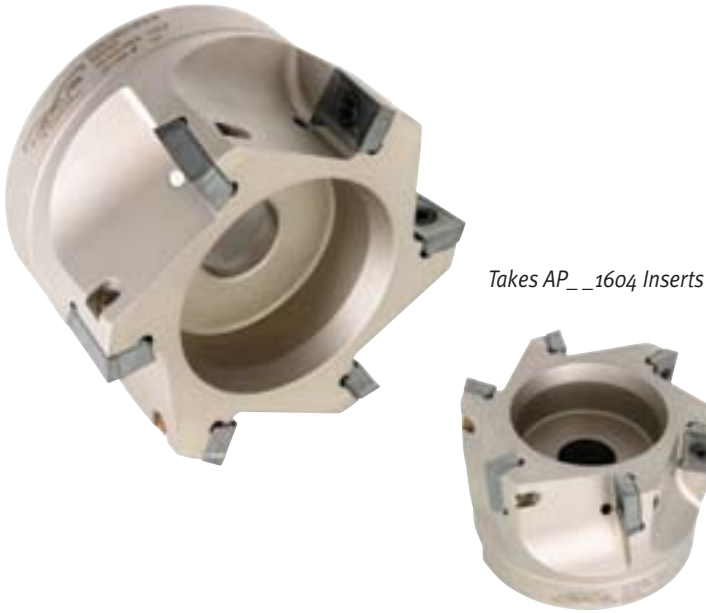

Features

- The holding power and rigidity of ShrinkFIT applied to a face mill
- Coolant-thru tool

Benefits

- Longer tool life or increased feed rates
- Better surface finish due to increased rigidity
- Longer insert life

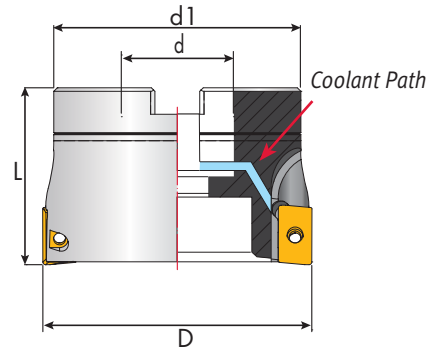
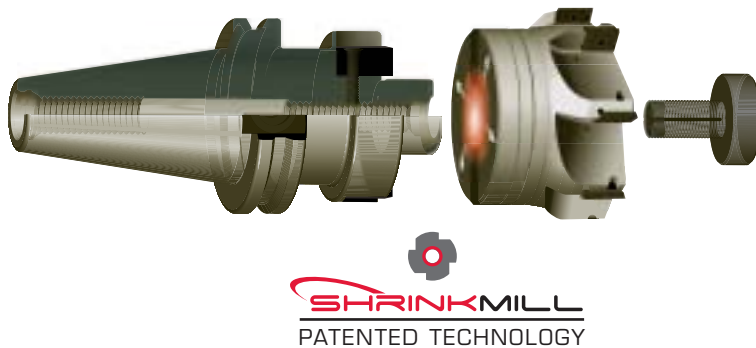

Insert	Insert Screw	Wrench
AP__1604	9319345	9355555

90° ShrinkMILL (SFM) Coolant Thru

Part No.	Description	Inserts	D	d	Z	d1	L
2321234	SFM90-2.00C-.750-4-16	AP__1604	2.00	0.75	4	1.69	1.57
2331235	SFM90-3.00C-1.25-6-16	AP__1604	3.00	1.25	6	2.76	1.97
2341236	SFM90-4.00C-1.25-7-16	AP__1604	4.00	1.25	7	2.76	1.97
2351237	SFM90-5.00C-1.50-8-16	AP__1604	5.00	1.50	8	3.82	2.48

Ramp Angle (α°) N/A. Toolholders found starting on page 114.



Takes SE_12T3 and SE_13T3 Inserts



Features

- Accuracy and rigidity of ShrinkFIT applied to a face mill
- Coolant-thru tool

Benefits

- Faster metal removal rates
- Better surface finish due to increased rigidity
- Longer insert life

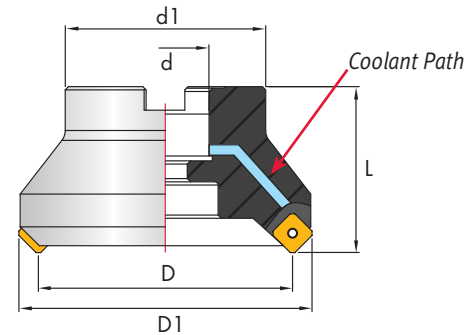

Insert	Insert Screw	Wrench
SE_12T3	9318345	9355555

45° ShrinkMILL (SFM) Coolant Thru

Part No.	Description	Inserts	D	d	D1	Z	d1	L
2421234	SFM45-2.00C-.750-4-13	SE_12T3	2.00	0.75	2.48	4	1.69	1.57
2431235	SFM45-3.00C-1.25-6-13	SE_12T3	3.00	1.25	3.66	6	2.76	1.97
2441236	SFM45-4.00C-1.25-7-13	SE_12T3	4.00	1.25	4.49	7	2.76	1.97
2451237	SFM45-5.00C-1.50-8-13	SE_12T3	5.00	1.50	5.43	8	3.82	2.48

Ramp Angle (α°) N/A. Toolholders found starting on page 114.



Takes SNKX Inserts



Features

- Perfect for copying
- Excels in plunge milling
- Great for roughing operations on pockets and 3D surfaces
- High productivity (more cutting edges per corner)

Benefits

- Lamina Technology
- 8 cutting edges
- Long tool life
- Excellent for dry machining of moulds and dies

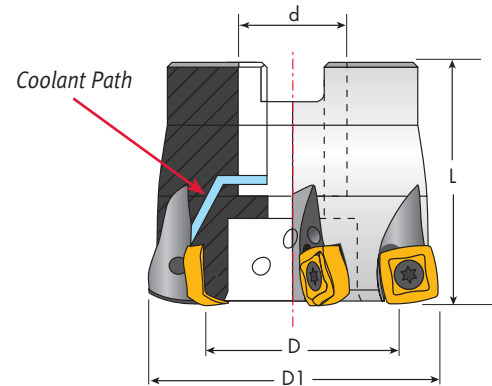
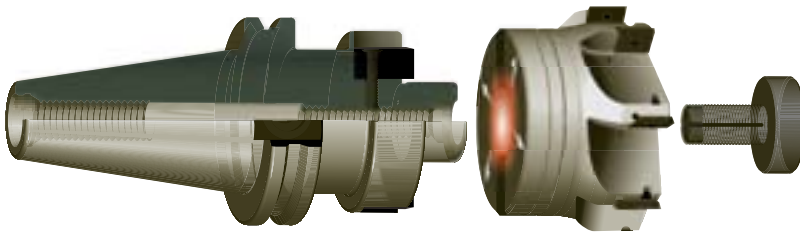

ShrinkMILL High Feed Face Mills Coolant Thru

Part No.	Description	D	d	H	Z	Insert	Ap	α°	Screw	Wrench
9223123	SHF-2.00-.750C-4SN9	2.00	0.75	1.570	4	SNKX09T3	0.040	1°	VT25	T8Flag
9233124	SHF-2.50-.075C-4SN9	2.50	0.75	1.570	4	SNKX09T3	0.040	.75°	VT25	T8Flag
9363123	SHF-3.00-1.00C-6SN9	3.00	1.00	1.57	6	SNKX09T3	0.040	.5°	VT25	T8Flag
9484123	SHF-4.00-1.25C-7SN9	4.00	1.25	2.00	7	SNKX09T3	0.040	.25°	VT25	T8Flag

α° = Ramp Angle. Toolholders found starting on page 114.



High-Performance Insert - 8 Cutting Edges

Part No.	Description	Grade	Programming Radius	Operation	Material
2502115	SNKX09T3-HF	LT 30	.165"	Roughing	P-K-H

P = steel, M = stainless, K = cast iron, S = high temp alloys, H = hardened material, N = aluminum & alloys

Nexus High-Performance Face Mills



High Feed Mills

Higher feed rates than standard face mills



Cast Iron Mill

Cast iron cutter with 10 cutting edges producing lower cost per corner

Attacking Heat & Vibration is in Our DNA.

NEXUS
CUTTING
TOOLS
by Techniks

Nexus ShrinkMILL and Face Mills

Nexus 90° Face Mill (FM)

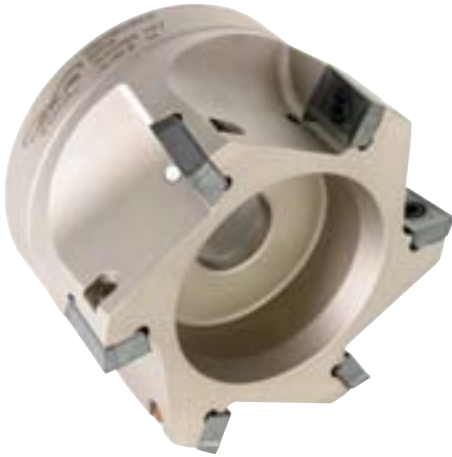

Takes AP__1604 Inserts



Features & Benefits

- H6 bore tolerance — 38% more accurate than standard face mills
- Less vibration
- Longer insert life

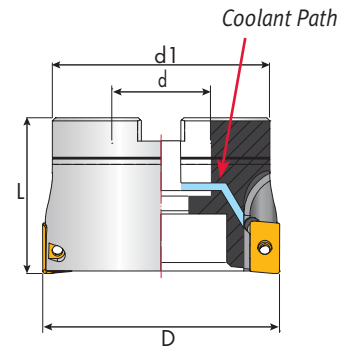

90° 16mm Face Mill (FM) Coolant Thru

Insert	Insert Screw	Wrench
AP__1604	9319345	9355555

Part No.	Description	D	d	Z	d1	L
2621234	FM90-2.00C-.750-4-16	2.00	0.75	4	1.69	1.57
2631235	FM90-3.00C-1.25-6-16	3.00	1.25	6	2.76	1.97
2641236	FM90-4.00C-1.25-7-16	4.00	1.25	7	2.76	1.97
2651237	FM90-5.00C-1.50-8-16	5.00	1.50	8	3.82	2.48

Ramp Angle (α°) N/A. Toolholders Pg. 114.

Nexus 45° Face Mill (FM)



Takes SE__12T3 and SE__13T3 Inserts



Features & Benefits

- H6 bore tolerance — 38% more accurate than standard face mills
- Less vibration
- Longer insert life

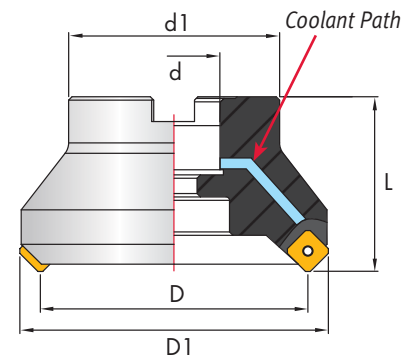

45° Face Mill (FM) Coolant Thru

Insert	Insert Screw	Wrench
SE__12T3	9318345	9355555

Part No.	Description	D	d	D1	Z	d1	L
2521234	FM45-2.00C-.750-4-13	2.00	0.75	2.48	4	1.69	1.57
2531235	FM45-3.00C-1.25-6-13	3.00	1.25	3.66	6	2.75	1.97
2541236	FM45-4.00C-1.25-7-13	4.00	1.25	4.49	7	2.75	1.97
2551237	FM45-5.00C-1.50-8-13	5.00	1.50	5.43	8	3.82	2.48

Ramp Angle (α°) N/A. Toolholders found starting on page 114.

Nexus High Feed Face Mills

8!  **Simplify**



Takes SNKX Inserts



Features

- Perfect for copying
- Excels in plunge milling
- Great for roughing operations on pockets and 3D surfaces
- High productivity (more cutting edges per corner)

Benefits

- Lamina Technology
- 8 cutting edges
- Long tool life
- Excellent for dry machining of moulds and dies

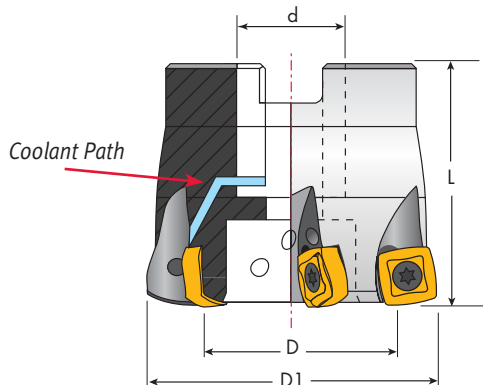

High Feed Face Mills Coolant-Thru

Part No.	Description	D	d	H	Z	Insert	Ap	α°	Screw	Wrench
9202123	HF-2.00-.750C-4SN9	2.00	0.75	1.57	4	SNKX09T3	0.040	1°	VT25	T8Flag
9212124	HF-2.50-.075C-4SN9	2.50	0.75	1.57	4	SNKX09T3	0.040	.75°	VT25	T8Flag
9353123	HF-3.00-1.00C-6SN9	3.00	1.00	1.57	6	SNKX09T3	0.040	.5°	VT25	T8Flag
9474123	HF-4.00-1.25C-7SN9	4.00	1.25	2.00	7	SNKX09T3	0.040	.25°	VT25	T8Flag

Ramp Angle (α°) N/A. Toolholders found starting on page 114.

High-Performance Insert - 8 Cutting Edges



Part No.	Description	Grade	Programming Radius	Operation	Material
2502115	SNKX09T3-HF	LT 30	.165"	Roughing	P-K-H

P = steel, M = stainless, K = cast iron, S = high temp alloys, H = hardened material, N = aluminum & alloys



The Power of 8!

Milling with 8 Cutting Edges



Excellent for near-to-shape workpieces

High stability reduces vibration

SNKX 09T3-HF-LT30

Designed to achieve the same feed per tooth as bigger inserts



More cutting edges per corner creates higher productivity

Nexus Tool introduces the SNKX High Feed Insert

Nexus Tool is pleased to announce the release of its revolutionary high feed SNKX 09T3 insert.

For the first time in the market you can have an 8 cutting edges square insert for high feed milling, with 09 size.

Features

- Perfect for copying
- Excels in plunge milling
- Great for roughing operations on pockets and 3D surfaces
- High productivity (more cutting edges per corner)

Benefits

- 8 cutting edges
- Long tool life
- Top quality with proprietary Sub-micron and ultra thick PVD technologies
- Positive geometry for low cutting forces
- Excellent for dry machining of moulds and dies
- Superior toughness & wear resistances for consistent performance and tool life



LAMINA
TECHNOLOGIES

SNKX for P-K-H

Part No.	Description	Grade	Programming Radius	Operation	Material
2502115	SNK09T3-HF	LT 30	.165	Roughing	P-K-H

P = steel, K = cast iron, H = hardened material

Nexus Cast Iron Milling Cutter



Takes PNEG1105 Inserts



Features & Benefits

- Negative pentagon insert designed for cast iron
- 10 cutting edges produce lower cost per corner

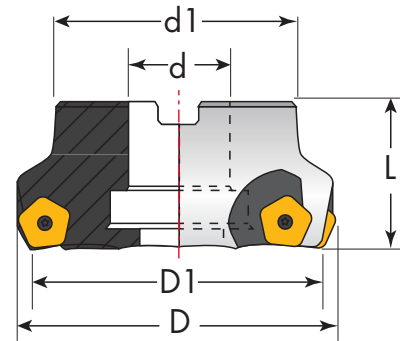

Decagon Cutter

Part	Description	Inserts	D	d	D1	Z	d1	L	Screw	Wrench
2139910	PN11-3.00-1.00-08	PNEG1105	3.00	1.00	2.87	8	2.36	2.00	I60M4 X 10	T15Flag
2149920	PN11-4.00-1.25-10	PNEG1105	4.00	1.25	3.93	10	3.16	2.00	I60M4 X 10	T15Flag
2159930	PN11-5.00-1.50-12	PNEG1105	5.00	1.50	4.90	12	3.94	2.50	I60M4 X 10	T15Flag
2169940	PN11-6.00-1.50-14	PNEG1105	6.00	1.50	5.80	14	4.53	2.50	I60M4 X 10	T15Flag

Toolholders found starting on page 114.



PNEG 11MM Inserts

Part No.	Description	Grade	Radius	Operation	Material
3959999	PNEG110512R-CM	152	0.047	General	K

P = steel, *M* = stainless, *K* = cast iron, *S* = high temp alloys, *H* = hardened material, *N* = aluminum & alloys

Hardware

Insert Screw	Wrench
9319345	9355555

Nexus Positive High Feed Face Mills



Takes SDMT Inserts



Features & Benefits

- Higher feed rates than standard face mills
- Less radial cutting forces
- Reduces spindle wear

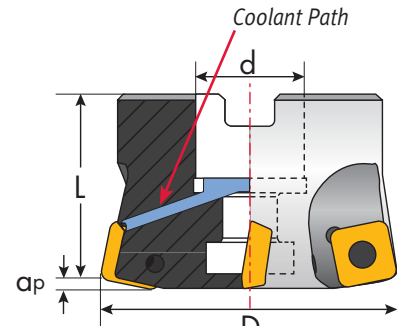

Tetrad Coolant-Thru

Part No.	Description	D	d	D1	ap	Z	α°	d1	L
2928860	HFM-2.00-0.75-SD09-04	2.00	0.75	1.52	0.055	4	1.5	1.78	2.00
2928865	HFM-2.50-0.75-SD09-05	2.50	0.75	1.97	0.055	5	1.5	1.97	2.00
2938870	HFM-3.00-1.25-SD12-05	3.00	1.25	2.35	0.071	5	1.5	2.75	2.50

Toolholders found starting on page 114. α° = Ramp Angle



SDMT 09 & 12 Inserts

Part No.	Description	Grade	Programming Radius	Radius	Operation	Material
3253310	SDMT09T312-DM	202	.098	0.047	General	P-K-H
3253320	SDMT120412-DM	202	.157	0.047	General	P-K-H

P = steel, M = stainless, K = cast iron, S = high temp alloys, H = hardened material, N = aluminum & alloys

Hardware

Insert Screw	Wedge Screw	Wedge	Insert Wrench	Wedge Wrench
9317446	9318347	9344454	9355444	9355555
9318547	9318347	9344454	9355555	9355555



All Nexus Tool products are backed by our 100% satisfaction guarantee.

Nexus High-Performance Milling Inserts

Nexus ShrinkMILL and Face Mills

The Concept



- High-performance in different materials – same as solid carbide tools do
- Eliminate insert guesswork
- Flexible – 1 grade across most materials

- Minimize changeover and set up time
- Much less inventory to buy and manage
- Always have the right insert available

Innovative Technology

Let Us Prove it to You!



The old way

- Breakthroughs in honing and coating technologies
- Thickest PVD coating in the industry
- Freedom from the cycle of "new grade" announcements



The **LAMINA** way



Simplify

Milling Inserts

EDP No.	Description	Grade	Radius	Operation	Material
1506065	ADKT1505PDTR-LT30-Insert	LT30	Facet	General	P-M-K-S-H
3153311	AOMT123608PETR-LT30-Insert	LT30	0.031	General	P-M-K-S-H
3151236	APEX100304PDFR-F01-Insert-5005-HP	5005	0.016	Finishing	N
3151239	APEX1604PDFR-F01-Insert-GH05-HP	GH05	Sharp	Finishing	N
1506501	APGT1003PDER-ALU-LT05-Insert	LT05	Facet	General	N-S
1506505	APGT1604PDER-ALU-LT05-Insert	LT05	Facet	General	N-S
3154411	APKT1003PDTR-LT30-Insert	LT30	Facet	General	P-M-K-S-H
3154422	APKT100304PDTR-LT30-Insert	LT30	0.016	General	P-M-K-S-H
3154433	APKT100312PDTR-LT30-Insert	LT30	0.047	Roughing	P-M-K-S-H
3154444	APKT100332PDTR-LT30-Insert	LT30	0.125	Roughing	P-M-K-S-H
3154455	APKT100340PDTR-LT30-Insert	LT30	0.157	Roughing	P-M-K-S-H
1506073	APKT1604 PDTR-LT30-Insert	LT30	Facet	General	P-M-K-S-H
1500300	APKT160424ER-LT30-Insert	LT30	0.094	Roughing	P-M-K-S-H
1506077	APKT1705PETR-LT30-Insert	LT30	Facet	General	P-M-K-S-H
1506085	APLX100308PDTR-LT30-Insert	LT30	0.031	General	P-M-K-S-H
1501567	APLX100340PDTR-LT30-Insert	LT30	0.157	Roughing	P-M-K-S-H
1506082	APLX1003PDTR-LT30-Insert	LT30	Facet	General	P-M-K-S-H
3153321	APMT1135PDTR-LT30-Insert	LT30	Facet	General	P-M-K-S-H
3153325	APMT160408PDTR-LT30-Insert	LT30	0.031	General	P-M-K-S-H
3954411	ODMT060508TN-LT30-Insert	LT30	0.031	General	P-M-K-S-H
3954415	ODMW060508TN-LT30-Insert	LT30	0.031	General	P-M-K-S-H
3954421	OFER070405TN-LT30-Insert	LT30	0.020	General	P-M-K-S-H
3954431	OFMT05T305TN-LT30-Insert	LT30	0.020	General	P-M-K-S-H
3954435	OFMT070405TN-LT30-Insert	LT30	0.020	General	P-M-K-S-H
3959999	PNEG110512R-CM-Insert-152	152	0.047	General	K
3355525	RCMT1204M0-LT10-Insert	LT30	NA	General	P-M-K-S-H
3355531	RDMT0803M0-LT30-Insert	LT30	NA	General	P-M-K-S-H
3355541	RDMT1204M0-LT30-Insert	LT30	NA	General	P-M-K-S-H
3254411	SDKT1204AETN-LT30-Insert	LT30	Chamfer	General	P-M-K-S-H
3253310	SDMT09T312-DM-Insert-202 (HF)	202	0.047	High Feed	P-M-K-S-H
3253320	SDMT120412-DM-Insert-202 (HF)	202	0.047	High Feed	P-M-K-S-H
3251239	SEET13T3-LH-Insert-WSK10-HP	WSK10	Chamfer	Finishing	N
2506509	SEGT1204AFEN-ALU-LT05-Insert	LT05	Chamfer	General	N-S
3254415	SEKN1203AFTN-LT30-Insert	LT30	Chamfer	General	P-M-K-S-H
3254431	SEKR1203AFTN-LT30-Insert	LT30	Chamfer	General	P-M-K-S-H
3254435	SEKT1204AFTN-LT30-Insert	LT30	Chamfer	General	P-M-K-S-H
2506169	SEKT12T3AGTN-LT30-Insert	LT30	Chamfer	General	P-M-K-S-H
2502115	SNKX09T3HF-LT30-Insert	LT30	0.031	High Feed	P-K-H
3567741	TPKN32PDTR-LT30-Insert	LT30	Chamfer	General	P-M-K-S-H
3567745	TPKN43PDTR-LT30-Insert	LT30	Chamfer	General	P-M-K-S-H
3567751	TPKR323PDTR-LT30-Insert	LT30	Chamfer	General	P-M-K-S-H
3567755	TPKR43PDTR-LT30-Insert	LT30	Chamfer	General	P-M-K-S-H
3567761	TPUN322-LT30-Insert	LT30	0.031	General	P-M-K-S-H
3451112	WPGT050315ZSR-Insert-351 (HF)	351	0.059	High Feed	P-M-K-S-H



APEX



APGT

P = steel
M = stainless
K = cast iron
S = high temp alloys
H = hardened material
N = aluminum & alloys



SDMT



SEKT

LT 30 Machining Guide

APKT 1604 PDTR



LAMINA
TECHNOLOGIES

HIGH-PERFORMANCE
3x the Thickness of Conventional PVD!

Nexus ShrinkMILL and Face Mills

Material Group	Gr. N°	VDI Group	Material Examples*	Hardness	D.O.C. [inch]		Feed [inch/tooth]		Vc [sfm]		Optimal cutting conditions			
					min	max	min	max	min	max	D.O.C.	Feed	Vc	
Steel	Non-alloyed	1	C35, Ck45, 1020, 1045, 1060, 28Mn6	125 HB	0.020	0.590	0.007	0.013	620	1080	0.157	0.009	820	
		2		190 HB	0.020	0.590	0.007	0.013	620	980	0.157	0.009	720	
		3		250 HB	0.020	0.590	0.007	0.013	620	820	0.157	0.009	650	
	Low alloyed	2	42CrMo4, St50, Ck60, 4140, 4340, 100Cr6	180 HB	0.020	0.590	0.006	0.010	490	780	0.157	0.008	650	
		4,6		230 HB	0.020	0.590	0.006	0.010	490	680	0.157	0.008	590	
		5,7		280 HB	0.020	0.590	0.006	0.009	420	620	0.157	0.007	490	
		8		350 HB	0.020	0.590	0.006	0.009	420	550	0.157	0.007	450	
	High alloyed	3	X40CrMoV5, H13, M42, D3, S6-5-2, 12Ni19	220 HB	0.020	0.422	0.005	0.009	290	490	0.118	0.007	420	
		10		280 HB	0.020	0.422	0.005	0.009	290	420	0.118	0.007	390	
		11		320 HB	0.020	0.422	0.005	0.007	190	360	0.118	0.006	320	
		11		350 HB	0.020	0.422	0.005	0.007	190	290	0.118	0.006	260	
Stainless Steel	Austenitic	4	304, 316, X5CrNi18-9	180 HB	0.020	0.590	0.006	0.010	620	820	0.157	0.008	720	
		14		240 HB	0.020	0.590	0.005	0.009	520	680	0.157	0.008	620	
	Duplex	5	X2CrNi23-4, S31500	290 HB	0.020	0.422	0.005	0.007	220	420	0.118	0.006	320	
		14		310 HB	0.020	0.422	0.005	0.007	220	390	0.118	0.006	290	
	Ferritic & Martensitic	6	410, X6Cr17, 17-4 PH, 430	200 HB	0.020	0.590	0.006	0.010	490	680	0.157	0.008	620	
		13		42 HRc	0.020	0.422	0.006	0.008	290	490	0.118	0.006	420	
Cast Iron	Grey	7	GG20, GG40, EN-GJL-250, No30B	150 HB	0.020	0.590	0.007	0.013	490	780	0.157	0.009	650	
		15		200 HB	0.020	0.590	0.007	0.013	490	720	0.157	0.009	590	
		16		250 HB	0.020	0.590	0.007	0.013	490	620	0.157	0.009	520	
	Malleable & Nodular	8	GGG40, GGG70, 50005	150 HB	0.020	0.590	0.006	0.011	320	650	0.157	0.008	590	
		17,19		200 HB	0.020	0.590	0.006	0.011	320	590	0.157	0.008	490	
		18,20		250 HB	0.020	0.590	0.006	0.011	320	490	0.157	0.008	420	
High Temp. Alloys	Fe, Ni & Co based	9	31,32	Incoloy 800	240 HB	0.020	0.422	0.005	0.007	80	140	0.118	0.006	100
		33	Inconel 700	250 HB	0.020	0.422	0.005	0.007	80	140	0.118	0.006	90	
		34	Stellite 21	350 HB	0.020	0.422	0.005	0.007	80	140	0.118	0.006	90	
	Ti based	10	36	TiAl6V4	-	0.020	0.422	0.005	0.008	130	210	0.118	0.007	180
		37	T40	-	0.020	0.422	0.005	0.007	90	180	0.118	0.006	130	
		38	X100CrMo13, 440C, G-X260NiCr42	45 HRc	0.020	0.211	0.004	0.007	130	260	0.079	0.006	190	
Hardened Mat.	Steel	38	G-X260NiCr42	50 HRc	0.020	0.126	0.004	0.006	130	220	0.059	0.005	180	
		38		55 HRc	0.020	0.063	0.004	0.006	130	190	0.039	0.005	160	
		40		Ni-Hard 2	400 HB	0.020	0.169	0.004	0.007	130	260	0.059	0.006	160
	White Cast Iron	41	G-X300CrMo15	55 HRc	0.020	0.063	0.004	0.006	90	190	0.039	0.005	130	
NF	Al (>8%Si)	12	25	AlSi12	130 HB	0.020	0.590	0.007	0.013	650	1310	0.157	0.010	910

Aluminum LT 05 Machining Guide

APGT 1604 PDER ALU LT 05



LAMINA
TECHNOLOGIES

HIGH-PERFORMANCE
3x the Thickness of Conventional PVD!

Material Group	Gr. N°	VDI Group	Material Examples*	Hardness	D.O.C. [inch]		Feed [inch/tooth]		Vc [sfm]		Optimal cutting conditions			
					min	max	min	max	min	max	D.O.C.	Feed	Vc	
NF	Al (<8%Si)	13	21, 22 23, 24	Si < 4 %	60 HB	0.020	0.591	0.006	0.013	1320	3960	0.157	0.006	1650
				4% < Si < 8 %	100 HB		0.591		0.005	0.011	825			1980
	Cooper Alloys	14	26,27,28	CuZn30	100 HB	0.020	0.591	0.005	0.011	330	2640	0.157	0.006	990
														Non-Metallic
-	30	Hard Rubber	-	0.591	0.013	264	990	0.157	0.005	495				
	-	-	Graphite	-	0.591	0.013	330	660	495					
H.T.A.	Ti based Alloys	10	36	Ti 1	-	0.020	0.591	0.004	0.013	115.5	198	0.157	0.005	148.5
				36	TiAl 6 V4		-		0.591	0.009	92.4			148.5

Nexus ShrinkMILL and Face Mills

Insert Grade Descriptions

LAMINA
TECHNOLOGIES

HIGH-PERFORMANCE

3x the Thickness of Conventional PVD!



Simplify

LT 05

PVD Coated with Chromium Nitride. Great for aluminum $\leq 6\%$ silicon and titanium

LT 30 Milling

A sub-micro grain substrate with a very thick high-pulse PVD coating with better adhesion than normal coatings. It can be run in all materials including aluminum

101

Uncoated Ultra Micro-grain Carbide

Used mostly for the general machining of aluminum

Can be used in all non-ferrous materials and high temperature alloys

202

PVD Coated Grade

Ultra-fine grain substrate provides excellent resistance to plastic deformation

NANO-TiAlN Coated

Used for wide range of general milling applications in a variety of materials

351

CVD Coated Grade

Very tough substrate with high wear-resistance

Multi-coating contains TiCN, Al₂O₃, and TiN

Used for rough milling of steel, stainless steel and cast iron

GH05

Uncoated ultra micro-grain carbide

A very sharp, high-polished geometry used in the general and finish machining of aluminum

WSK10

Uncoated ultra micro-grain carbide

A very sharp, high-polished geometry used in the general and finish machining of aluminum

LT 30 Machining Guide

SEKT 12T3 PLSN



LAMINA
TECHNOLOGIES

HIGH-PERFORMANCE
3x the Thickness of Conventional PVD!

Material Group	Gr. N°	VDI Group	Material Examples*	Hardness	D.O.C. [inch]		Feed [inch/tooth]		Vc [sfm]		Optimal cutting conditions			
					min	max	min	max	min	max	D.O.C.	Feed	Vc	
Steel	Non-alloyed	1	C35, Ck45, 1020, 1045, 1060, 28Mn6	125 HB	0.020	0.276	0.007	0.018	620	1080	0.118	0.013	820	
				190 HB	0.020	0.276	0.007	0.018	620	980	0.118	0.013	720	
				250 HB	0.020	0.276	0.007	0.018	620	820	0.118	0.013	650	
	Low alloyed	2	42CrMo4, St50, Ck60, 4140, 4340, 100Cr6	180 HB	0.020	0.276	0.006	0.014	490	780	0.118	0.012	650	
				230 HB	0.020	0.276	0.006	0.014	490	680	0.118	0.012	590	
				280 HB	0.020	0.276	0.006	0.013	420	620	0.118	0.010	490	
				350 HB	0.020	0.276	0.006	0.013	420	550	0.118	0.010	450	
	High alloyed	3	X40CrMoV5, H13, M42, D3, S6-5-2, 12Ni19	220 HB	0.020	0.197	0.005	0.013	290	490	0.089	0.010	420	
				280 HB	0.020	0.197	0.005	0.013	290	420	0.089	0.010	390	
				320 HB	0.020	0.197	0.005	0.010	190	360	0.089	0.009	320	
350 HB				0.020	0.197	0.005	0.010	190	290	0.089	0.009	260		
Stainless Steel	Austenitic	4	304, 316, X5CrNi18-9	180 HB	0.020	0.276	0.006	0.013	620	820	0.118	0.010	720	
				240 HB	0.020	0.276	0.005	0.011	520	680	0.118	0.010	620	
	Duplex	5	X2CrNiN23-4, S31500	290 HB	0.020	0.197	0.005	0.010	220	420	0.089	0.009	320	
				310 HB	0.020	0.197	0.005	0.010	220	390	0.089	0.009	290	
	Ferritic & Martensitic	6	410, X6Cr17, 17-4 PH, 430	200 HB	0.020	0.276	0.006	0.013	490	680	0.118	0.010	620	
				42 HRc	0.020	0.197	0.006	0.010	290	490	0.089	0.009	420	
Cast Iron	Grey	7	GG20, GG40, EN-GJL-250, No30B	150 HB	0.020	0.276	0.007	0.018	490	780	0.118	0.013	650	
				200 HB	0.020	0.276	0.007	0.018	490	720	0.118	0.013	590	
				250 HB	0.020	0.276	0.007	0.018	490	620	0.118	0.013	520	
	Malleable & Nodular	8	GGG40, GGG70, 50005	150 HB	0.020	0.276	0.006	0.016	320	650	0.118	0.012	590	
				200 HB	0.020	0.276	0.006	0.016	320	590	0.118	0.012	490	
				250 HB	0.020	0.276	0.006	0.016	320	490	0.118	0.012	420	
High Temp. Alloys	Fe, Ni & Co based	9	Incoloy 800	240 HB	0.020	0.197	0.005	0.010	80	140	0.089	0.009	100	
				250 HB	0.020	0.197	0.005	0.010	80	140	0.089	0.009	90	
				350 HB	0.020	0.197	0.005	0.010	80	140	0.089	0.009	90	
	Ti based	10	TiAl6V4	-	0.020	0.197	0.005	0.011	130	210	0.089	0.010	180	
				T40	-	0.020	0.197	0.005	0.010	90	180	0.089	0.009	130
Hardened Mat.	Steel	11	X100CrMo13, 440C, G-X260NiCr42	45 HRc	0.020	0.098	0.004	0.010	130	260	0.059	0.008	190	
				50 HRc	0.020	0.069	0.004	0.009	130	220	0.044	0.008	180	
				55 HRc	0.020	0.059	0.004	0.008	130	190	0.030	0.007	160	
	Chilled Cast Iron	40	Ni-Hard 2	400 HB	0.020	0.079	0.004	0.010	130	260	0.044	0.008	160	
	White Cast Iron	41	G-X300Cr-Mo15	55 HRc	0.020	0.059	0.004	0.008	90	190	0.030	0.007	130	
NF	Al (>8%Si)	12	25	AlSi12	130 HB	0.020	0.276	0.007	0.018	650	1310	0.118	0.015	910

Nexus ShrinkMILL and Face Mills

High Feed Machining Guide

SNKX 09T3-HF

Corner radius for CNC programming: 0.165"



LAMINA
TECHNOLOGIES

HIGH-PERFORMANCE
3x the Thickness of Conventional PVD!

Material Group	Gr. N°	VDI Group	Material Examples*	Hardness	D.O.C. [inch]		Feed [inch/tooth]		Vc [sfm]		Optimal cutting conditions			
					min	max	min	max	min	max	D.O.C.	Feed	Vc	
Steel	Non-alloyed	1	1	C35, Ck45,	125 HB	0.004	0.039	0.011	0.083	620	1080	0.022	0.043	820
			2	1020, 1045,	190 HB	0.004	0.039	0.011	0.077	620	980	0.022	0.043	720
			3	1060, 28Mn6	250 HB	0.004	0.039	0.011	0.059	620	820	0.022	0.043	650
	Low alloyed	2	6	42CrMo4,	180 HB	0.004	0.039	0.010	0.077	490	780	0.020	0.039	650
			4,6	St50, Ck60,	230 HB	0.004	0.039	0.010	0.067	490	680	0.020	0.039	590
			5,7	4140, 4340,	280 HB	0.004	0.039	0.009	0.063	420	620	0.020	0.035	490
			8	100Cr6	350 HB	0.004	0.039	0.009	0.059	420	550	0.020	0.035	450
	High alloyed	3	10	X40CrMoV5,	220 HB	0.004	0.039	0.008	0.067	290	490	0.020	0.035	420
			10	H13, M42,	280 HB	0.004	0.039	0.008	0.063	290	420	0.020	0.035	390
			11	D3, S6-5-2,	320 HB	0.004	0.031	0.008	0.059	190	360	0.016	0.031	320
			11	12Ni19	350 HB	0.004	0.031	0.008	0.055	190	290	0.016	0.031	260
	Stainless Steel	Austenitic	4	14	304, 316,	180 HB								
14				X5CrNi18-9	240 HB									
Duplex		5	14	X2CrNiN23-4,	290 HB									
			14	S31500	310 HB									
Ferritic & Martensitic		6	12	410, X6Cr17,	200 HB									
			13	17-4 PH, 430	42 HRc									
Cast Iron	Grey	7	15	GG20, GG40,	150 HB	0.004	0.039	0.008	0.094	490	780	0.024	0.043	650
			15	EN-GJL-250,	200 HB	0.004	0.039	0.008	0.094	490	720	0.024	0.043	590
			16	No30B	250 HB	0.004	0.039	0.008	0.094	490	620	0.024	0.043	520
	Malleable & Nodular	8	17,19	GGG40,	150 HB	0.004	0.039	0.008	0.071	320	650	0.020	0.039	590
			17,19	GGG70,	200 HB	0.004	0.039	0.008	0.071	320	590	0.020	0.039	490
			18,20	50005	250 HB	0.004	0.039	0.008	0.071	320	490	0.020	0.039	420
High Temp. Alloys	Fe, Ni & Co based	9	31,32	Incoloy 800	240 HB									
			33	Inconel 700	250 HB									
			34	Stellite 21	350 HB									
	Ti based	10	36	TiAl6V4	-									
			37	T40	-									
Hardened Mat.	Steel	11	38	X100CrMo13,	45 HRc	0.004	0.024	0.006	0.043	130	260	0.016	0.028	190
			38	440C,	50 HRc	0.004	0.020	0.006	0.039	130	220	0.012	0.026	180
			38	G-X260NiCr42	55 HRc	0.004	0.016	0.006	0.035	130	190	0.012	0.024	160
	Chilled Cast Iron	40	Ni-Hard 2	400 HB	0.004	0.024	0.006	0.043	130	260	0.016	0.028	160	
	White Cast Iron	41	G-X300Cr-Mo15	55 HRc	0.004	0.016	0.006	0.035	90	190	0.012	0.024	130	
NF	Al (>8%Si)	12	25	AlSi12	130 HB									

Solutions that are innovative, accurate, and simple.

PowerLOC Indexable End Mills

- Much better accuracy
- Better balance
- Positively grips the tool shank



Simplify

**We're Making
a Better Connection
Between the Cutting Tool
and Spindle.**



POWERLOC Square Shank Adapter

- Use with Techniks ER Chucks to turn them into PowerLOC Milling Holders



Innovative

Indexable End Mills



- Positive High-Feed

- High-Feed

Attacking Heat & Vibration is in Our DNA.



Nexus PowerLOC Indexable End Mills



We're Making a Better Connection
Between the Cutting Tool and Spindle.



Simplify

PowerLOC Square Shank End Mill

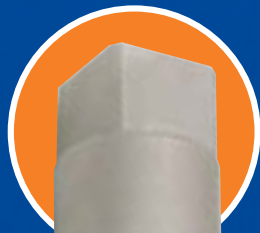

Eliminate Tool Slippage
in Collet Chucks!



Problem

- ❶ Inaccuracy of indexable end mill shanks
- ❷ Slippage (axial tool movement)
- ❸ Inability to remove the steel tool shanks from high technology ShrinkFIT chucks

Solution

- ❶ Develop a shank that works with collet chucks and ShrinkFIT holders
- ❷ Reduced diameter for ShrinkFIT Technology
- ❸ Develop a square on the back of the shank to eliminate any tool pressure slippage

Advantages & Benefits

- Extend tool life or increase feed rates
- Use indexable end mills in the two most accurate toolholders—Collet Chucks and ShrinkFIT

PowerLOC & ShrinkLOC For Best Insert Life

T.I.R. Causes Vibration. Vibration Causes Poor Cutting and Premature Failure in Inserts.



Typical Tolerance of a 3/4" Indexable End Mill

Shank Diameter	=	3/4"
Shank Tolerance	=	-0.0009"
	+	0.0000"
ID Tolerance of End Mill Holder	=	+0.0009"
	-	-0.0000"
Total Out of Tolerance	=	0.0018"

For Every 0.0001" T.I.R., Cutting Tools Lose 10% Tool Life.

.0018" T.I.R.
Typical Use
End Mill Holder

Average Tool Life

.0004" T.I.R.
Better Option
PowerLOC Collet Chuck

Up to 25% More Tool Life

.0002" T.I.R.
Best Option
ShrinkLOC Holder

Up to 50% Additional Tool Life

POWERLOC
PATENTED TECHNOLOGY

We're Making a Better Connection Between the Cutting Tool and Spindle.

Nexus PowerLOC Indexable End Mills

PowerLOC Indexable End Mills

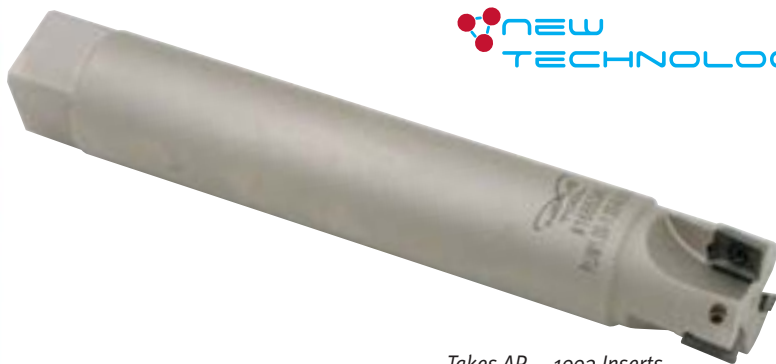

Takes AP__1003 Inserts

Features

- Much better accuracy
- Better balance
- Positively grips the tool shank

Benefits

- Extend cutting tool life or increase feed rates
- Lower tooling cost
- Eliminates the need for milling chucks and end mill holders

How PowerLOC End Mills Reduce Scrap to Save Money

- PowerLOC Square Drive eliminates tool slippage issues for more accurate cutting, especially under heavy loads.
- Overall better balance, greater rigidity, and accuracy (.0002" T.I.R.) of the toolholder and end mill reduces wear on cutting inserts, extending life.
- Longer insert life = less down time for tool changes, and make more parts per insert.

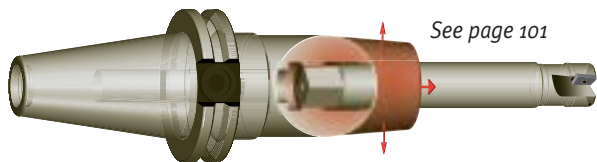

Used with either a ShrinkLOC holder or a PowerLOC collet chuck, you get all the performance benefits – PLUS – you don't have to invest in a milling chuck!

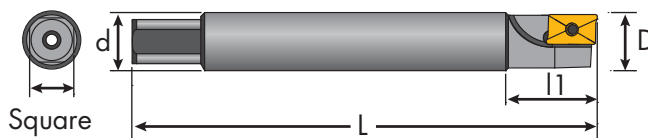
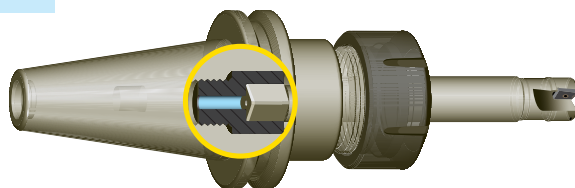

Insert	Insert Screw	Wrench
AP__1003	9316446	9355333

α° = Ramp Angle

End Mills (PLIM) Coolant Thru and Non-Coolant

Part No.	Description	No. of Inserts	Coolant Thru	Collet Size	D	d	L	l1	Square	α°
1633345	PLIM.500-.500C-4.00-1-10	1	*	ER32 or ER40	.500	.500	4.00	0.79	0.380	32°
1655345	PLIM.750-.750C-5.00-2-10	2	*	ER32 or ER40	.750	.750	5.00	0.98	0.563	7.5°
1666345	PLIM1.00-1.00C-6.00-3-10	3	*	ER40	1.00	1.00	6.00	0.98	0.750	5°
1632345	PLIM.500-.500-4.00-1-10	1		ER32 or ER40	.500	.500	4.00	0.79	0.380	32°
1654345	PLIM.750-.750-5.00-2-10	2		ER32 or ER40	.750	.750	5.00	0.98	0.563	7.5°
1665345	PLIM1.00-1.00-6.00-3-10	3		ER40	1.00	1.00	6.00	0.98	0.750	5°

PowerLOC Square Shank High-Feed End Mills



Use with ShrinkLOC holder (pg 101)
or PowerLOC Collet Chuck (pg 234)

Takes SNKX09T Inserts



Features

- PowerLOC Square Shank
- Takes 8 cornered inserts
- Cost per corner cut in half
- Runs in steel, cast iron & hardened materials

Benefits

- Eliminate costly milling chucks
- Reduce Scrap
- No tool slippage
- Eliminate inaccurate end mill holders that cause chatter and short tool life
- Faster feed rates
- Extend insert life up to 2X

We're Making a Better Connection
Between the Cutting Tool and Spindle.

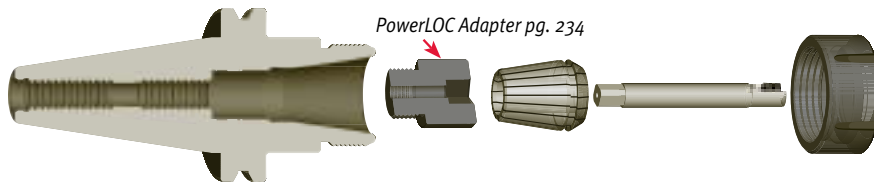

PowerLOC Adapter pg. 234



PowerLOC Coolant Thru High-Feed End Mills

Part No.	Description	D	d	L	Z	Insert	l1	Ap	α°
6612118	PLHF-1.00-1.00C-5.00-3SN9	1.00	1.00	5.00	3	SNKX09T3	2.36	.039	3.5°
6612117	PLHF-1.00-1.00C-8.00-3SN9	1.00	1.00	8.00	3	SNKX09T3	3.94	.039	3.5°
6712119	PLHF-1.25-1.25C-5.00-4SN9	1.25	1.25	5.00	4	SNKX09T3	1.20	.039	2°
6712120	PLHF-1.25-1.25C-8.00-3SN9	1.25	1.25	8.00	3	SNKX09T3	1.20	.039	2°

Nexus PowerLOC Indexable End Mills



All Nexus Tool products are backed by our 100% satisfaction guarantee.

Adapters & Toolholders for PowerLOC End Mills



Adapts ER Chucks into PowerLOC Milling Holders

PowerLOC Square Shank Adapters turn our standard collet chucks into milling holders capable of performing heavier milling jobs than you ever thought possible.



**We're Making a Better Connection
Between the Cutting Tool and Spindle.**

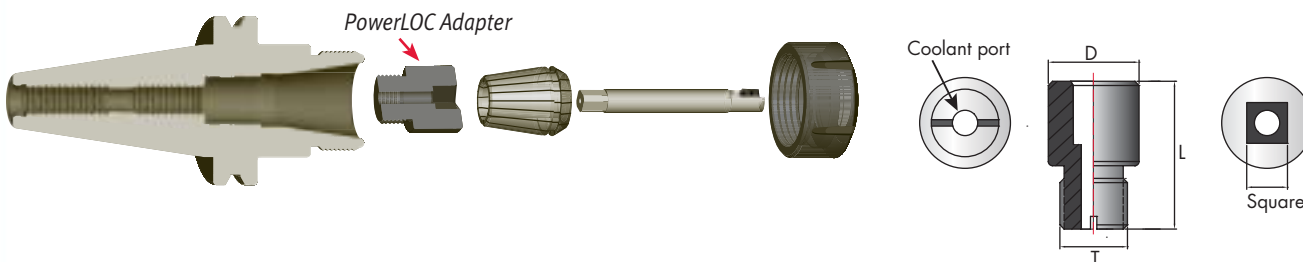

PowerLOC Straight Shank Adapters (PLSS) Coolant-Thru

Part No.	Description	Collet Size	L	D	Square	Tool Shank	T=Thread
9398765	PLSS.500xM16	ER32	1.380	.850	0.380	.500	M16x2.0
9397764	PLSS.750xM16	ER32	1.380	.850	0.563	.750	M16x2.0
9396764	PLSS.500xM20	ER40	1.97	1.280	0.380	.500	M20x2.0
9396763	PLSS.750xM20	ER40	1.97	1.280	0.563	.750	M20x2.0
9396762	PLSS1.00xM20	ER40	1.97	1.280	0.750	1.00	M20x2.0
9396766	PLSS1.25xM24	ER50	1.59	1.35	.763	1.25	M24X2.0



purchase collet separately

PowerLOC CAT40 ER Toolholders

Part No.	Collet	L	D	Max. Shank	Wrench	Thread
CAT40-ER-32-2.76	ER32	2.76	1.97	.788	9904616	M16X2.0
CAT40-ER-32-4	ER32	4	1.97	.788	9904616	M16X2.0
CAT40-ER-40-3.15	ER40	3.15	2.48	1.023	9904617	M120X2.0

PowerLOC CAT50 ER Toolholders

Part No.	Collet	L	D	Max. Shank	Wrench	Thread
CAT50-ER-32-4	ER32	4	1.97	.788	9904616	M16X2.0
CAT50-ER-32-6	ER32	6	1.97	.788	9904616	M16X2.0
CAT50-ER-40-4	ER40	4	2.48	1.023	9904617	M20X2.0

HIGH-PERFORMANCE
3x the Thickness of Conventional PVD!



The Power of 8!

Milling with 8 Cutting Edges

Excellent for near-to-shape workpieces

High stability reduces vibration

SNKX 09T3-HF-LT30

Designed to achieve the same feed per tooth as bigger inserts

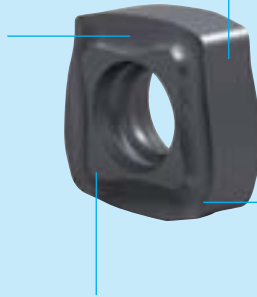

More cutting edges per corner creates higher productivity

Nexus Tool introduces the SNKX High-Feed Insert

Nexus Tool is pleased to announce the release of its revolutionary High-Feed SNKX 09T3 insert.

For the first time in the market you can have an 8 cutting edges square insert for High-Feed milling, with 09 size.

Features

- Perfect for copying
- Excels in plunge milling
- Great for roughing operations on pockets and 3D surfaces
- High productivity (more cutting edges per corner)



LAMINA
TECHNOLOGIES

Benefits

- 8 cutting edges
- Long tool life
- Top quality with proprietary Sub-micron and ultra thick PVD technologies
- Positive geometry for low cutting forces
- Excellent for dry machining of moulds and dies
- Superior toughness & wear resistances for consistent performance and tool life

SNKX for P-K-H

Part No.	Description	Grade	Programming Radius	Operation	Material
2502115	SNK09T3-HF	LT 30	.165	Roughing	P-K-H

P = steel, K = cast iron, H = hardened material

Nexus Indexable End Mills (IEM90)



Takes AP__ Inserts

Benefits

- H13 tool steel provides a more rigid tool for less deflection in the cut, and extended tool life
- H6 shank tolerance provides 38% better T.I.R. to improve accuracy and extend insert life

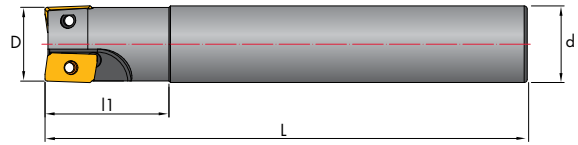

Indexable End Mills (IEM90) Coolant Thru

Part No.	Description	Insert	D	d	L	Z	l1	α°
1632234	IEM90-.500-.500C-4.00-1-10	AP__1003	.500	.500	4.00	1	0.787	32°
1642235	IEM90-.625-.625C-5.00-2-1	AP__1003	.625	.625	5.00	2	0.984	5°
1652236	IEM90-.750-.750C-5.00-2-10	AP__1003	.750	.750	5.00	2	0.984	7.5°
1662237	IEM90-1.00-1.00C-6.00-3-10	AP__1003	1.00	1.00	6.00	3	0.984	5°
1672238	IEM90-1.25-1.25C-6.00-3-16	AP__1604	1.25	1.25	6.00	3	1.772	3°
1682239	IEM90-1.50-1.25C-6.00-4-16	AP__1604	1.50	1.25	6.00	4	1.772	2.7°

Indexable End Mills (IEM90)

Part No.	Description	Insert	D	d	L	Z	l1	α°
1631234	IEM90-.500-.500-4.00-1-10	AP__1003	.500	.500	4.00	1	0.787	32°
1641235	IEM90-.625-.625-5.00-2-10	AP__1003	.625	.625	5.00	2	0.984	5°
1651236	IEM90-.750-.750-5.00-2-10	AP__1003	.750	.750	5.00	2	0.984	7.5°
1661237	IEM90-1.00-1.00-6.00-3-10	AP__1003	1.00	1.00	6.00	3	0.984	5°
1676238	IEM90-1.25-1.25-6.00-3-16	AP__1604	1.25	1.25	6.00	3	1.772	3°
1686239	IEM90-1.50-1.25-6.00-4-16	AP__1604	1.50	1.25	6.00	4	1.772	2.7°



Takes SNKX09T Inserts

Features

- 8 corners
- Runs in steel, cast iron & hardened materials

Benefits

- Less inventory = lower cost
- Higher productivity and lower cost per corner
- Cost per corner cut in half

Indexable High-Feed End Mills

Coolant Thru

Part No.	Description	D	d	L	Z	Insert	l1	Ap	α°
6602118	HFEM-1.00-1.00CW-5.00-3SN9	1.00	1.00	5.00	3	SNKX09T3	2.36	.039	3.5°
6602117	HFEM-1.00-1.00CW-8.00-3SN9	1.00	1.00	8.00	3	SNKX09T3	3.94	.039	3.5°
6702119	HFEM-1.25-1.25CW-5.00-4SN9	1.25	1.25	5.00	4	SNKX09T3	2.36	.039	2°
6702120	HFEM-1.25-1.25CW-8.00-3SN9	1.25	1.25	8.00	3	SNKX09T3	3.94	.039	2°

W=Weldon. Z = number of inserts. α° = Ramp Angle

Nexus Positive High-Feed Indexable End Mills



Takes WPGT Inserts

Features & Benefits

- Higher feed rates than standard end mills
- Less radial cutting forces
- Reduces spindle wear

Insert	Insert Screw	Wrench
WPGT0503	160M3.5X08TT	WT10P & WT15P

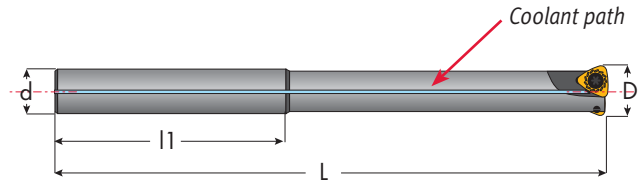

Positive High Feed Indexable End Mills - Coolant Thru

Part No.	Description	D	d	L	Z	l1	Ap
1658810	HFEM-0.75-0.75-7.00-WP05-02	0.75	0.75	5.00	2	3.25	0.06



Takes SDMT Inserts

Use in a ShrinkFIT holder to increase tool life up to 50%.

ShrinkFIT holders can be found starting on page 92
End mill holders can be found starting on page 74.

Insert	Insert Screw	Wrench
SDMT09T	160M3.5X08TT	WT101P
SDMT12T	160M4X8.4	WT151P

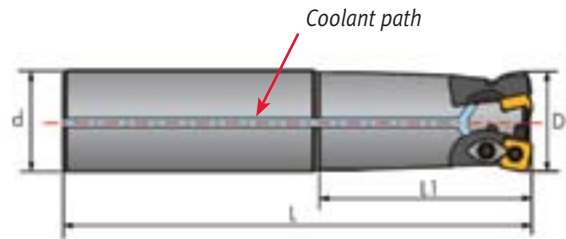

Positive High Feed Indexable End Mills - Coolant Thru

Part No.	Description	D	d	L	Z	l1	Ap
1668820	HFEM-1.00-1.00-5.50-SD09-02	1.00	1.00	5.50	2	3.25	0.06
1668822	HFEM-1.00-1.00-7.00-SD09-02	1.00	1.00	7.00	2	3.25	0.06
1678830	HFEM-1.25-1.25-8.00-SD09-03	1.25	1.25	8.00	3	3.25	0.06
1678840	HFEM-1.25-1.25-8.00-SD12-02	1.25	1.25	8.00	2	3.25	0.07
1688850	HFEM-1.50-1.50-8.00-SD12-03	1.50	1.50	8.00	3	3.25	0.07

Nexus PowerLOC Indexable End Mills

High-Performance Milling Inserts



APEX



APGT

Part No.	Description	Grade	Radius	Operation	Material
1506065	ADKT1505PDTR-LT30-Insert	LT30	Facet	General	P-M-K-S-H
3153311	AOMT123608PETR-LT30-Insert	LT30	0.031	General	P-M-K-S-H
3151236	APEX100304PDFR-F01-Insert-5005-HP	5005	0.016	Finishing	N
3151239	APEX1604PDFR-F01-Insert-GH05-HP	GH05	Sharp	Finishing	N
1506501	APGT1003PDER-ALU-LT05-Insert	LT05	Facet	General	N-S
1506505	APGT1604PDER-ALU-LT05-Insert	LT05	Facet	General	N-S
3154411	APKT1003PDTR-LT30-Insert	LT30	Facet	General	P-M-K-S-H
3154422	APKT100304PDTR-LT30-Insert	LT30	0.016	General	P-M-K-S-H
3154433	APKT100312PDTR-LT30-Insert	LT30	0.047	Roughing	P-M-K-S-H
3154444	APKT100332PDTR-LT30-Insert	LT30	0.125	Roughing	P-M-K-S-H
3154455	APKT100340PDTR-LT30-Insert	LT30	0.157	Roughing	P-M-K-S-H
1506073	APKT1604 PDTR-LT30-Insert	LT30	Facet	General	P-M-K-S-H
1500300	APKT160424ER-LT30-Insert	LT30	0.094	Roughing	P-M-K-S-H
1506077	APKT1705PETR-LT30-Insert	LT30	Facet	General	P-M-K-S-H
1506085	APLX100308PDTR-LT 30-Insert	LT30	0.031	General	P-M-K-S-H
1501567	APLX100340PDTR-LT30-Insert	LT30	0.157	Roughing	P-M-K-S-H
1506082	APLX1003PDTR-LT30-Insert	LT30	Facet	General	P-M-K-S-H
3153321	APMT1135PDTR-LT30-Insert	LT30	Facet	General	P-M-K-S-H
3153325	APMT160408PDTR-LT30-Insert	LT30	0.031	General	P-M-K-S-H
3954411	ODMT060508TN-LT30-Insert	LT30	0.031	General	P-M-K-S-H
3954415	ODMW060508TN-LT30-Insert	LT30	0.031	General	P-M-K-S-H
3954421	OFER070405TN-LT30-Insert	LT30	0.020	General	P-M-K-S-H
3954431	OFMT05T305TN-LT30-Insert	LT30	0.020	General	P-M-K-S-H
3954435	OFMT070405TN-LT30-Insert	LT30	0.020	General	P-M-K-S-H
3959999	PNEG110512R-CM-Insert-152	152	0.047	General	K
3355525	RCMT1204M0-LT10-Insert	LT30	NA	General	P-M-K-S-H
3355531	RDMT0803M0-LT30-Insert	LT30	NA	General	P-M-K-S-H
3355541	RDMT1204M0-LT30-Insert	LT30	NA	General	P-M-K-S-H
3254411	SDKT1204AETN-LT30-Insert	LT30	Chamfer	General	P-M-K-S-H
3253310	SDMT09T312-DM-Insert-202 (HF)	202	0.047	High-Feed	P-M-K-S-H
3253320	SDMT120412-DM-Insert-202 (HF)	202	0.047	High-Feed	P-M-K-S-H
3251239	SEET13T3-LH-Insert-WSK10-HP	WSK10	Chamfer	Finishing	N
2506509	SEGT1204AFEN-ALU-LT05-Insert	LT05	Chamfer	General	N-S
3254415	SEKN1203AFTN-LT30-Insert	LT30	Chamfer	General	P-M-K-S-H
3254431	SEKR1203AFTN-LT30-Insert	LT30	Chamfer	General	P-M-K-S-H
3254435	SEKT1204AFTN-LT30-Insert	LT30	Chamfer	General	P-M-K-S-H
2506169	SEKT12T3AGTN-LT30-Insert	LT30	Chamfer	General	P-M-K-S-H
2502115	SNKX09T3HF-LT30-Insert	LT30	0.031	High-Feed	P-K-H
3567741	TPKN32PDTR-LT30-Insert	LT30	Chamfer	General	P-M-K-S-H
3567745	TPKN43PDTR-LT30-Insert	LT30	Chamfer	General	P-M-K-S-H
3567751	TPKR323PDTR-LT30-Insert	LT30	Chamfer	General	P-M-K-S-H
3567755	TPKR43PDTR-LT30-Insert	LT30	Chamfer	General	P-M-K-S-H
3567761	TPUN322-LT30-Insert	LT30	0.031	General	P-M-K-S-H
3451112	WPGT050315ZSR-Insert-351 (HF)	351	0.059	High-Feed	P-M-K-S-H

P = steel

M = stainless

K = cast iron

S = high temp alloys

H = hardened material

N = aluminum & alloys



SDMT



SEKT

LT 30 Machining Guide

APLX LT 30



LAMINA
TECHNOLOGIES

HIGH-PERFORMANCE
3x the Thickness of Conventional PVD!

Material Group	No.	Material example	Brinell hardness	d.o.c [inch]		feed [inch/tooth]		Cutting Speed [SFM]	
				min	max	min	max	min	max
Low Carbon Steel	1	Ck15	150	0.020	0.591	0.004	0.015	590	984
		Ck45	180				0.010		853
		1020 1045	210				0.009		722
Alloy steel	2	42 CrMo 4	180	0.020	0.591	0.003	0.009	426	656
		St 50-2	230						590
		Ck60	280	0.020	0.003	0.007	328	525	
		1060 4140	320					459	
High Alloy Steel	3	X40	220	0.020	0.591	0.003	0.007	295	426
		CrMoV 5	280						361
		1 40	320	0.020	0.276	0.003	0.006	197	328
		NiCrMo 6	350						295
Hardened Steel		S 2-10-1-8	400	0.020	0.157	0.004	0.006	131	262
		H13	480		0.079				230
		D2 HSS M42	550		0.039				197
Austenitic and Duplex Stainless Steel	4	X5 CrNi 18 9 304	210 to 250	0.020	0.354	0.004	0.009	623	820
	5	X2 CrNiMo 17 2 2 316	230 to 270	0.020	0.354	0.004	0.008	525	689
	6	X6 CrNiMoTi 17 12 2 316 Ti Duplex / Nitronic	—	0.020	0.354	0.003	0.007	230	394
Ferritic Stainless Steel	7	X8 Cr 7 430	annealed	0.020	0.354	0.003	0.008	492	754
Martensitic Stainless Steel	8	X15 Cr 13 410	annealed	0.020	0.354	0.003	0.008	426	689
			treated					295	492
Grey Cast iron	9	GG 20	140 to 230	0.020	0.354	0.004	0.010	492	787
		GG 25							722
		GG 30							623
Nodular Cast Iron	10	GGG 40	210	0.020	0.354	0.004	0.009	328	656
		GGG 50	260						525
		GGG 70	310						426
White Cast Iron		G-X260Ni- Cr42	400	0.020	0.118	0.004	0.006	98	197
Ni based alloy	11	Inconel 625	—	0.020	0.197	0.003	0.006	82	115
		Inconel 718						92	125
		Hastelloy C						131	213
Ti based alloy	12	TiAl 6 V4	-----	0.020	0.197	0.003	0.007	115	197
		T40	-----				0.006	92	131

Nexus PowerLOC Indexable End Mills



All Nexus Tool products are backed by our 100% satisfaction guarantee.

Aluminum Machining Guide

APGT 1003 PDER ALU LT 05



LAMINA
TECHNOLOGIES

HIGH-PERFORMANCE
3x the Thickness of Conventional PVD!

Material Group	Gr. N°	VDI Group	Material Ex-amples*	Hardness	D.O.C. [inch]		Feed [inch/tooth]		Vc [sfm]		Optimal cutting conditions			
					min	max	min	max	min	max	D.O.C.	Feed	Vc	
NF	Al (<8%Si)	13	21, 22, 23, 24	Si < 4 %	60 HB	0.012	0.354	0.005	0.008	1320	3960	0.118	0.006	1650
			4% < Si < 8 %	100 HB			0.004	0.007	825	1980	1320			
	Cooper Alloys	14	26, 27, 28	CuZn30	100 HB	0.012	0.354	0.004	0.007	330	2640	0.118	0.006	990
	Non-Metallic	15	29	Fiber Plastics	-		0.354		0.008	264	1650	0.118	0.005	660
			30	Hard Rubber	-	0.012	0.354	0.005	0.008	264	990			495
-			Graphite	-		0.354		0.008	330	660	495			
H.T.A.	Ti based Alloys	10	36	Ti 1	-	0.012	0.197	0.003	0.008	115.5	198	0.079	0.005	148.5
			36	TiAl 6 V4	-		0.197		0.006	92.4	148.5			115.5

Nexus PowerLOC Indexable End Mills

LT 30 Machining Guide

APKT 1604 PDTR



LAMINA
TECHNOLOGIES

HIGH-PERFORMANCE
3x the Thickness of Conventional PVD!

Material Group	Gr. N°	VDI Group	Material Examples*	Hardness	D.O.C. [inch]		Feed [inch/tooth]		Vc [sfm]		Optimal cutting conditions			
					min	max	min	max	min	max	D.O.C.	Feed	Vc	
Steel	Non-alloyed	1	C35, Ck45,	125 HB	0.020	0.590	0.007	0.013	620	1080	0.157	0.009	820	
		2	1020, 1045,	190 HB	0.020	0.590	0.007	0.013	620	980	0.157	0.009	720	
		3	1060, 28Mn6	250 HB	0.020	0.590	0.007	0.013	620	820	0.157	0.009	650	
	Low alloyed	2	6	42CrMo4, St50, Ck60, 4140, 4340, 100Cr6	180 HB	0.020	0.590	0.006	0.010	490	780	0.157	0.008	650
			4,6		230 HB	0.020	0.590	0.006	0.010	490	680	0.157	0.008	590
			5,7		280 HB	0.020	0.590	0.006	0.009	420	620	0.157	0.007	490
			8		350 HB	0.020	0.590	0.006	0.009	420	550	0.157	0.007	450
	High alloyed	3	10	X40CrMoV5, H13, M42, D3, S6-5-2, 12Ni19	220 HB	0.020	0.422	0.005	0.009	290	490	0.118	0.007	420
			10		280 HB	0.020	0.422	0.005	0.009	290	420	0.118	0.007	390
			11		320 HB	0.020	0.422	0.005	0.007	190	360	0.118	0.006	320
			11		350 HB	0.020	0.422	0.005	0.007	190	290	0.118	0.006	260
	Stainless Steel	Austenitic	4	304, 316, X5CrNi18-9	180 HB	0.020	0.590	0.006	0.010	620	820	0.157	0.008	720
14			240 HB		0.020	0.590	0.005	0.009	520	680	0.157	0.008	620	
Duplex		5	X2CrNiN23-4, S31500	290 HB	0.020	0.422	0.005	0.007	220	420	0.118	0.006	320	
				14	310 HB	0.020	0.422	0.005	0.007	220	390	0.118	0.006	290
Ferritic & Martensitic		6	410, X6Cr17, 17-4 PH, 430	200 HB	0.020	0.590	0.006	0.010	490	680	0.157	0.008	620	
				13	42 HRc	0.020	0.422	0.006	0.008	290	490	0.118	0.006	420
Cast Iron	Grey	7	GG20, GG40, EN-GJL-250, No30B	150 HB	0.020	0.590	0.007	0.013	490	780	0.157	0.009	650	
				200 HB	0.020	0.590	0.007	0.013	490	720	0.157	0.009	590	
				250 HB	0.020	0.590	0.007	0.013	490	620	0.157	0.009	520	
	Malleable & Nodular	8	GGG40, GGG70, 50005	150 HB	0.020	0.590	0.006	0.011	320	650	0.157	0.008	590	
				200 HB	0.020	0.590	0.006	0.011	320	590	0.157	0.008	490	
				250 HB	0.020	0.590	0.006	0.011	320	490	0.157	0.008	420	
High Temp. Alloys	Fe, Ni & Co based	9	Incoloy 800	240 HB	0.020	0.422	0.005	0.007	80	140	0.118	0.006	100	
				250 HB	0.020	0.422	0.005	0.007	80	140	0.118	0.006	90	
				350 HB	0.020	0.422	0.005	0.007	80	140	0.118	0.006	90	
	Ti based	10	TiAl6V4	-	0.020	0.422	0.005	0.008	130	210	0.118	0.007	180	
				-	0.020	0.422	0.005	0.007	90	180	0.118	0.006	130	
				-	0.020	0.422	0.005	0.007	90	180	0.118	0.006	130	
Hardened Mat.	Steel	11	X100CrMo13, 440C, G-X260NiCr42	45 HRc	0.020	0.211	0.004	0.007	130	260	0.079	0.006	190	
				50 HRc	0.020	0.126	0.004	0.006	130	220	0.059	0.005	180	
				55 HRc	0.020	0.063	0.004	0.006	130	190	0.039	0.005	160	
	Chilled Cast Iron	40	Ni-Hard 2	400 HB	0.020	0.169	0.004	0.007	130	260	0.059	0.006	160	
	White Cast Iron	41	G-X300CrMo15	55 HRc	0.020	0.063	0.004	0.006	90	190	0.039	0.005	130	
NF	Al (>8%Si)	12	25	AlSi12	130 HB	0.020	0.590	0.007	0.013	650	1310	0.157	0.010	910

Nexus PowerLOC Indexable End Mills

Aluminum LT 05 Machining Guide

APGT 1604 PDER ALU LT 05



LAMINA
TECHNOLOGIES

HIGH-PERFORMANCE
3x the Thickness of Conventional PVD!

Material Group	Gr. N°	VDI Group	Material Examples*	Hardness	D.O.C. [inch]		Feed [inch/tooth]		Vc [sfm]		Optimal cutting conditions			
					min	max	min	max	min	max	D.O.C.	Feed	Vc	
NF	Al (<8%Si)	13	21, 22 23, 24	Si < 4 %	60 HB	0.020	0.591	0.006	0.013	1320	3960	0.157	0.006	1650
				4% < Si < 8 %	100 HB		0.591	0.005	0.011	825	1980			1320
	Cooper Alloys	14	26,27,28	CuZn30	100 HB	0.020	0.591	0.005	0.011	330	2640	0.157	0.006	990
				Non-Metallic	15	29	Fiber Plastics	-	0.591		0.013	264	1650	
30	Hard Rubber	-	0.591			0.006	0.013	264	990	0.157	0.005	495		
-	Graphite	-	0.591				0.013	330	660			495		
H.T.A.	Ti based Alloys	10	36	Ti 1	-	0.020	0.591	0.004	0.013	115.5	198	0.157	0.005	148.5
			36	TiAl 6 V4	-		0.591		0.009	92.4	148.5			115.5

LAMINA Insert Descriptions

LT05

PVD Coated with Chromium Nitride.
Great for aluminum $\leq 6\%$ silicon and titanium

LT 30 Milling

A sub-micro grain substrate with a very thick high-pulse PVD coating

It has better adhesion than normal coatings.
It can be run in all materials including aluminum

101

Uncoated Fine-grade Carbide

A very sharp high polished grade

Used mostly for the general machining of aluminum

Can be used in all non-ferrous materials and high temperature alloys

202

PVD Coated Grade

Ultra-fine grain substrate provides excellent resistance to plastic deformation

NANO-TiAlN Coated

Good for wide range of general milling applications in a variety of materials

351

CVD Coated Grade

Very tough substrate with high wear-resistance

Multi-coating contains TICN, Al_2O_3 , and TIN

Good for rough milling of steel, stainless steel and cast iron

5005

Uncoated ultra micro-grain carbide

A very sharp high-polished geometry

Used in the general and finish machining of aluminum

GH05

Uncoated ultra micro-grain carbide

A very sharp high-polished geometry

Used in the general and finish machining of aluminum

High-Feed Machining Guide

SNKX 09T3-HF

Corner radius for CNC programming: 0.165"



LAMINA
TECHNOLOGIES

HIGH-PERFORMANCE
3x the Thickness of Conventional PVD!

Material Group		Gr. N°	VDI Group	Material Examples*	Hardness	D.O.C. [inch]		Feed [inch/tooth]		Vc [sfm]		Optimal cutting conditions			
						min	max	min	max	min	max	D.O.C.	Feed	Vc	
Steel	Non-alloyed	1	1	C35, Ck45,	125 HB	0.004	0.039	0.011	0.083	620	1080	0.022	0.043	820	
			2	1020, 1045,	190 HB	0.004	0.039	0.011	0.077	620	980	0.022	0.043	720	
			3	1060, 28Mn6	250 HB	0.004	0.039	0.011	0.059	620	820	0.022	0.043	650	
	Low alloyed	2	6	42CrMo4,	180 HB	0.004	0.039	0.010	0.077	490	780	0.020	0.039	650	
			4,6	St50, Ck60,	230 HB	0.004	0.039	0.010	0.067	490	680	0.020	0.039	590	
			5,7	4140, 4340,	280 HB	0.004	0.039	0.009	0.063	420	620	0.020	0.035	490	
			8	100Cr6	350 HB	0.004	0.039	0.009	0.059	420	550	0.020	0.035	450	
	High alloyed	3	10	X40CrMoV5,	220 HB	0.004	0.039	0.008	0.067	290	490	0.020	0.035	420	
			10	H13, M42,	280 HB	0.004	0.039	0.008	0.063	290	420	0.020	0.035	390	
			11	D3, S6-5-2,	320 HB	0.004	0.031	0.008	0.059	190	360	0.016	0.031	320	
			11	12Ni19	350 HB	0.004	0.031	0.008	0.055	190	290	0.016	0.031	260	
Stainless Steel	Austenitic	4	14	304, 316,	180 HB										
			14	X5CrNi18-9	240 HB										
	Duplex	5	14	X2CrNi23-4,	290 HB										
			14	S31500	310 HB										
	Ferritic & Martensitic	6	12	410, X6Cr17,	200 HB										
			13	17-4 PH, 430	42 HRC										
Cast Iron	Grey	7	15	GG20, GG40,	150 HB	0.004	0.039	0.008	0.094	490	780	0.024	0.043	650	
			15	EN-GJL-250,	200 HB	0.004	0.039	0.008	0.094	490	720	0.024	0.043	590	
			16	No30B	250 HB	0.004	0.039	0.008	0.094	490	620	0.024	0.043	520	
	Malleable & Nodular	8	17,19	GGG40,	150 HB	0.004	0.039	0.008	0.071	320	650	0.020	0.039	590	
			17,19	GGG70,	200 HB	0.004	0.039	0.008	0.071	320	590	0.020	0.039	490	
			18,20	50005	250 HB	0.004	0.039	0.008	0.071	320	490	0.020	0.039	420	
High Temp. Alloys	Fe, Ni & Co based	9	31,32	Incoloy 800	240 HB										
			33	Inconel 700	250 HB										
			34	Stellite 21	350 HB										
	Ti based	10	36	TiAl6V4	-										
			37	T40	-										
Hardened Mat.	Steel	11	38	X100CrMo13,	45 HRC	0.004	0.024	0.006	0.043	130	260	0.016	0.028	190	
			38	440C,	50 HRC	0.004	0.020	0.006	0.039	130	220	0.012	0.026	180	
			38	G-X260NiCr42	55 HRC	0.004	0.016	0.006	0.035	130	190	0.012	0.024	160	
	Chilled Cast Iron	40	Ni-Hard 2	400 HB	0.004	0.024	0.006	0.043	130	260	0.016	0.028	160		
	White Cast Iron	41	G-X300Cr-Mo15	55 HRC	0.004	0.016	0.006	0.035	90	190	0.012	0.024	130		
NF	Al (>8%Si)	12	25	AlSi12	130 HB										

Nexus PowerLOC Indexable End Mills

Nexus Indexable Drills



Simplify

HIGH-PERFORMANCE
3x the Thickness of Conventional PVD!

Features

- Coolant fed through center
- Special -ring design to help seal coolant
- H13 steel for rigidity and tool life
- 4x depth to diameter
- High-performance inserts reduce setup time and inventory of inserts

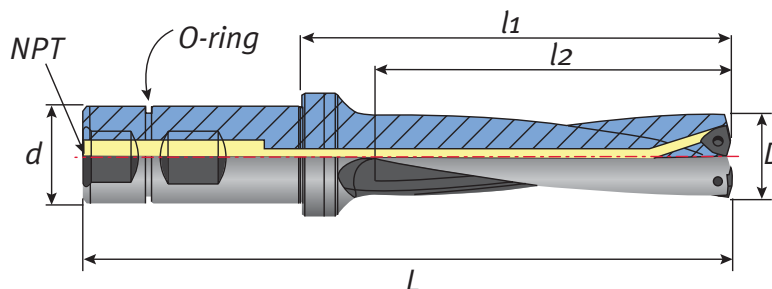

4WD Indexable Drills

Part No.	Description	D	d	Drill Depth I3	NTP Thread P	I2	I1	L	Insert	Wrench
1741234	4WD.625-.750C-2.50-3	0.625"	0.750"	2.50"	1/8"	2.69"	3.44"	5.48"	WC_0302	T8
1751244	4WD.750-.750C-3.00-3	0.750"	0.750"	3.00"	1/8"	3.20"	3.94"	6.00"	WC_0302	T8
1751254	4WD.875-1.00C-3.50-4	0.875"	1.00"	3.50"	1/8"	3.69"	4.43"	6.72"	WC_0402	T8
1761264	4WD1.00-1.00C-4.00-4	1.00"	1.00"	4.00"	1/8"	4.20"	4.94"	7.23"	WC_0402	T8
1771284	4WD1.25-1.25C-5.00-6	1.25"	1.25"	5.00"	1/4"	5.20"	6.14"	8.43"	WC_06T3	T15
1771294	4WD1.375-1.25C-5.50-6	1.375"	1.25"	5.50"	1/4"	5.69"	6.64"	8.92"	WC_06T3	T15
1781334	4WD1.50-1.25C-6.00-6	1.50"	1.25"	6.00"	1/4"	6.20"	7.26"	9.54"	WC_06T3	T15
1781354	4WD1.75-1.50C-7.00-6	1.75"	1.50"	7.00"	1/4"	7.20"	8.26"	10.95"	WC_06T3	T15
1781374	4WD2.00-1.50C-8.00-8	2.00"	1.50"	8.00"	1/4"	8.20"	9.34"	12.03"	WC_0804	T15
1791394	4WD2.25-1.50C-9.00-8	2.25"	1.50"	9.00"	1/4"	9.20"	10.34"	13.03"	WC_0804	T15

Drilling Inserts

Part No.	Description	Grade	Radius	Operation	Material
3441111	WCMX030208R53-201-Drill Insert	201	0.031	General	P-M-K-S-H
3441121	WCMX040208NN-LT30-Drill Insert	LT30	0.031	General	P-M-K-S-H
3441125	WCMX050308NN-LT30-Drill Insert	LT30	0.031	General	P-M-K-S-H
3441131	WCMX06T308NN-LT30-Drill Insert	LT30	0.031	General	P-M-K-S-H
3441135	WCMX080412NN-LT30-Drill Insert	LT30	0.047	General	P-M-K-S-H

P = steel, M = stainless, K = cast iron, S = high temp alloys, H = hardened material, N = aluminum & alloys

Nexus Turning and Boring Tools and Inserts



Negative Toolholders



Negative Boring Bars

LAMINA
TECHNOLOGIES
HIGH-PERFORMANCE



High-Performance Inserts



Aluminum Inserts



Positive Toolholders

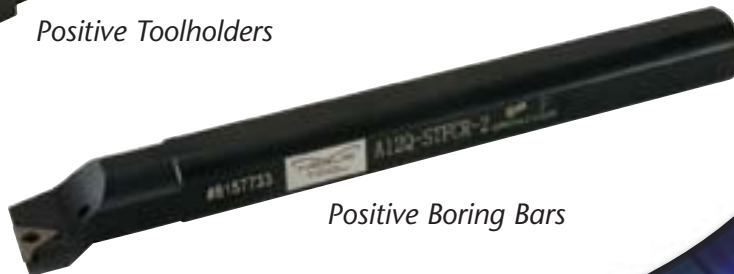

Positive Boring Bars

Attacking Heat & Vibration is in Our DNA.

NEXUS
CUTTING
TOOLS
by Techniks

Nexus Turning & Boring Tools and Inserts

Negative Turning Toolholders

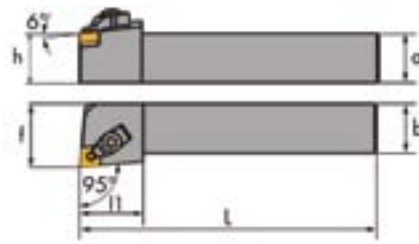

right hand shown - see table for left hand

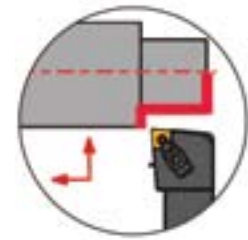

turning facing

MCLNR/L 95°

Part No.	Description	a=h	b	L	l1	f	Insert	Clamp Screw	Shim	Clamp	Lock Pin	Wrench
8669911	MCLNR-16-4D	1.00	1.00	6.00	1.25	1.25	CN_ _43_	9344888	9333111	9344111	9344666	9322121
8669912	MCLNL-16-4D	1.00	1.00	6.00	1.25	1.25	CN_ _43_	9344888	9333111	9344111	9344666	9322121

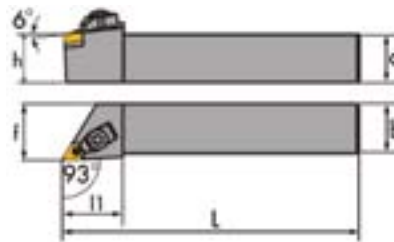

right hand shown - see table for left hand

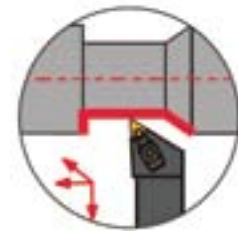

profile turning

MDJNR/L 93°

Part No.	Description	a=h	b	L	l1	f	Insert	Clamp Screw	Shim	Clamp	Lock Pin	Wrench
8679921	MDJNR-16-4D	1.00	1.00	6.00	1.50	1.25	DN_ _43_	9344888	9344888	93344222	9344777	9322121
8679922	MDJNL-16-4D	1.00	1.00	6.00	1.50	1.25	DN_ _43_	9344888	9344888	93344222	9344777	9322121



HIGH-PERFORMANCE
3x the Thickness of Conventional PVD!

Negative Turning Toolholders

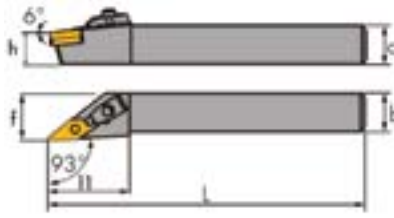

right hand shown - see table for left hand



profile turning

MVJNR/L 93°

Part No.	Description	a=h	b	L	l1	f	Insert	Clamp Screw	Shim	Clamp	Lock Pin	Wrench
8689931	MVJNR-16-3D	1.00	1.00	6.00	1.77	1.25	VN_33_	9344888	9333666	9344333	9344555	9322121
8689932	MVJNL-16-3D	1.00	1.00	6.00	1.77	1.25	VN_33_	9344888	9333666	9344333	9344555	9322121

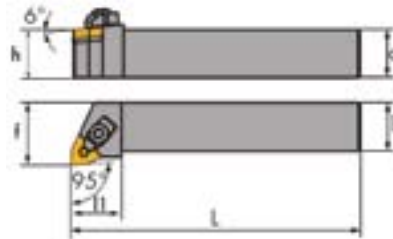

right hand shown - see table for left hand



turning & facing

MWLNR/L 95°

Part No.	Description	a=h	b	L	l1	f	Insert	Clamp Screw	Shim	Clamp	Lock Pin	Wrench
8649941	MWLNR-16-4D	1.00	1.00	6.00	1.38	1.25	WN_43_	9344888	9333888	9344111	9344666	9322121
8649942	MWLNL-16-4D	1.00	1.00	6.00	1.38	1.25	WN_43_	9344888	9333888	9344111	9344666	9322121



Negative Boring Bars – Coolant-Thru



PCLNR/L 95°

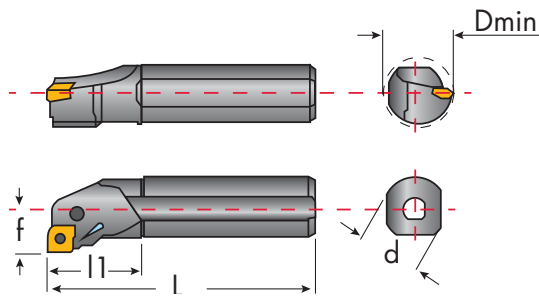

right hand shown - see table for left hand

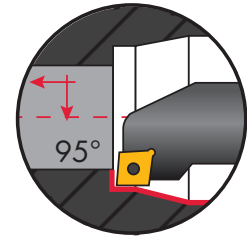

boring & facing

Part No.	Description	d	Dmin	L	l1	f	Insert	Shim	Shim Pin	Lever	Lock Screw	Wrench
8168811	A16T-PCLNR-4	1.00	1.280	12	1.570	0.640	CN_43_	-	-	9335333	9345222	9322116
8168821	A16T-PCLNL-4	1.00	1.400	12	1.570	0.640	CN_43_	-	-	9335333	9345222	9322116
8168812	A20T-PCLNR-4	1.25	1.460	12	1.970	0.77	CN_43_	9333252	9333999	9335222	9345333	9322121
8168822	A20T-PCLNL-4	1.25	1.530	12	1.570	0.77	CN_43_	9333252	9333999	9335222	9345333	9322121
8168813	A24U-PCLNR-4	1.50	1.760	14	2.360	0.890	CN_43_	9333252	9333999	9335222	9345333	9322121
8168823	A24U-PCLNL-4	1.50	1.760	14	2.360	0.890	CN_43_	9333252	9333999	9335222	9345333	9322121



PDUNR/L 93°

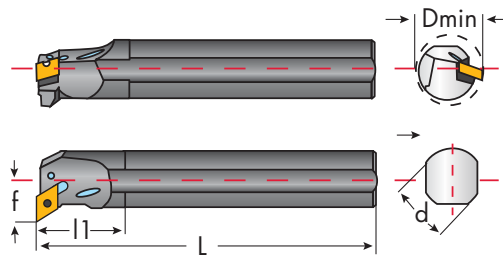

right hand shown - see table for left hand

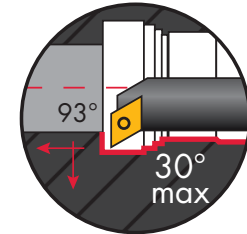

profile boring

Part No.	Description	d	Dmin	L	l1	f	Insert	Shim	Shim Pin	Lever	Lock Screw	Wrench
8178831	A16T-PDUNR-3	1.00	1.300	12	1.380	0.750	DN_33_	-	-	9335111	9345111	9322111
8178841	A16T-PDUNL-3	1.00	1.300	12	1.380	0.750	DN_33_	-	-	9335111	9345111	9322111
8178832	A20T-PDUNR-4	1.25	1.700	12	1.970	1.000	DN_43_	9333353	9333999	9335222	9345333	9322121
8178842	A20T-PDUNL-4	1.25	1.700	12	1.970	1.000	DN_43_	9333353	9333999	9335222	9345333	9322121
8178833	A24U-PDUNR-4	1.50	2.000	14	1.970	1.13	DN_43_	9333353	9333999	9335222	9345333	9322121
8178843	A24U-PDUNL-4	1.50	2.000	14	1.970	1.13	DN_43_	9333353	9333999	9335222	9345333	9322121



HIGH-PERFORMANCE
3x the Thickness of Conventional PVD!

Nexus Boring Bars – Coolant-Thru

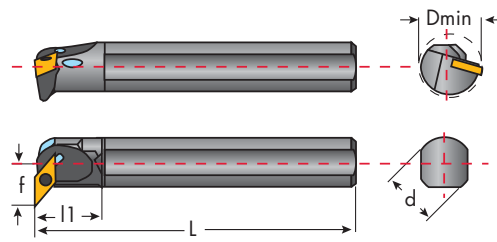

right hand shown - see table for left hand

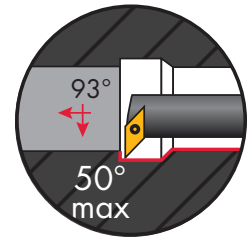

profile boring

PVUNR/L 93°

Part No.	Description	d	Dmin	L	l1	f	Insert	Lever	Lock Screw	Wrench
8188851	A16T-PVUNR-3	1.00	1.500	12	1.380	0.800	VN_33_	9335111	9345111	9322111
8188861	A16T-PVUNL-3	1.00	1.500	12	1.380	0.800	VN_33_	9335111	9345111	9322111
8188852	A20T-PVUNR-3	1.25	2.250	12	1.570	1.13	VN_33_	9335111	9345111	9322111
8188862	A20T-PVUNL-3	1.25	2.250	12	1.570	1.13	VN_33_	9335111	9345111	9322111

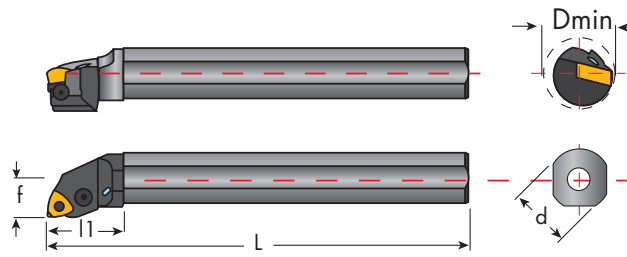

right hand shown - see table for left hand

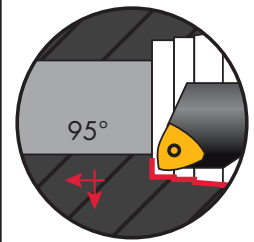

boring & facing

PVLNR/L 95°

Part No.	Description	d	Dmin	L	l1	f	Insert	Shim	Shim Pin	Lever	Lock Screw	Wrench
8148871	A16T-PVLNR-4	1.00	1.300	12	1.770	0.750	WN_43_	-	-	9335333	9345222	9322116
8188881	A16T-PVLNL-4	1.00	1.300	12	1.770	0.750	WN_43_	-	-	9335333	9345222	9322116
8148872	A20T-PVLNR-4	1.25	1.700	12	1.970	1.000	WN_43_	9333757	9333999	9335222	9345333	9322121
8188882	A20T-PVLNL-4	1.25	1.700	12	1.970	1.000	WN_43_	9333757	9333999	9335222	9345333	9322121
8188873	A24U-PVLNR-4	1.50	2.000	14	2.360	1.000	WN_43_	9333757	9333999	9335222	9345333	9322121
8188883	A24U-PVLNL-4	1.50	2.000	14	2.360	1.000	WN_43_	9333757	9333999	9335222	9345333	9322121



Magia Negative Turning & Boring Inserts



NN Chipbreaker

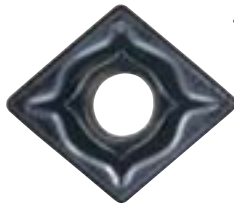

NX Chipbreaker

Features

- Ultra-thick, patented PVD coating dramatically increases tool life
- Very low flank and plastic deformation minimize or eliminate offsets
- Advanced high-performance grade offers ultimate versatility
- Exceptional performance in High Temp Alloys



LAMINA
TECHNOLOGIES

HIGH-PERFORMANCE
3x the Thickness of Conventional PVD!

Negative Turning and Boring Inserts

Part No.	Description	Grade	Radius	Operation	Material
6608011	CNMG431NN-LT1000-Insert	LT1000	0.016	Finishing	P-M-K-S-H
6608016	CNMG432NN-LT1000-Insert	LT1000	0.031	General	P-M-K-S-H
6608021	CNMG433NN-LT1000-Insert	LT1000	0.047	Roughing	P-M-K-S-H
6608026	CNMG432NX-LT1000-Insert	LT1000	0.031	General	P-M-K-S-H
6608031	CNMP432NN-LT1000-Insert	LT1000	0.031	General	P-M-K-S-H
6608036	CNMP433NN-LT1000-Insert	LT1000	0.047	Roughing	P-M-K-S-H
7608011	DNMG331NN-LT1000-Insert	LT1000	0.016	Finishing	P-M-K-S-H
7608016	DNMG332NN-LT1000-Insert	LT1000	0.031	General	P-M-K-S-H
7608021	DNMG431NN-LT1000-Insert	LT1000	0.016	Finishing	P-M-K-S-H
7608026	DNMG432NN-LT1000-Insert	LT1000	0.031	General	P-M-K-S-H
7608031	DNMG433NN-LT1000-Insert	LT1000	0.047	Roughing	P-M-K-S-H
3578011	TNMG331NN-LT1000-Insert	LT1000	0.016	Finishing	P-M-K-S-H
3578016	TNMG332NN-LT1000-Insert	LT1000	0.031	General	P-M-K-S-H
3578021	TNMG333NN-LT1000-Insert	LT1000	0.047	Roughing	P-M-K-S-H
3578026	TNMP332NN-LT1000-Insert	LT1000	0.031	General	P-M-K-S-H
8608011	VNMG331NN-LT1000-Insert	LT1000	0.016	Finishing	P-M-K-S-H
8608016	VNMG332NN-LT1000-Insert	LT1000	0.031	General	P-M-K-S-H
4608011	WNMG431NN-LT1000-Insert	LT1000	0.016	Finishing	P-M-K-S-H
4608016	WNMG432NN-LT1000-Insert	LT1000	0.031	General	P-M-K-S-H
4608021	WNMG432NX-LT1000-Insert	LT1000	0.031	General	P-M-K-S-H
4608026	WNMG433NN-LT1000-Insert	LT1000	0.047	Roughing	P-M-K-S-H
4608031	WNMP432NN-LT1000-Insert	LT1000	0.031	General	P-M-K-S-H
3463321	WNMG432NN-LT1000	LT1000	0.031	General	P-M-K-S-H

P = steel, M = stainless, K = cast iron, S = high temp alloys, H = hardened material, N = aluminum & alloys

Negative Turning & Boring Inserts – LT10, LT05

LT10 Inserts for Negative Turning and Boring

CNMG

Part No.	Description	Grade	Radius	Operation	Material
6607029	CNMG431-NN	LT 10	0.016	Finishing	P-M-K-S-H
6607033	CNMG432-NN	LT 10	0.031	General	P-M-K-S-H
6607037	CNMG433-NN	LT 10	0.047	Roughing	P-M-K-S-H

CNMP

Part No.	Description	Grade	Radius	Operation	Material
6607041	CNMP432-NN	LT 10	0.031	General	P-M-K-S-H
6607045	CNMP433-NN	LT 10	0.047	Roughing	P-M-K-S-H

DNMG

Part No.	Description	Grade	Radius	Operation	Material
7607061	DNMG331-NN	LT 10	0.016	Finishing	P-M-K-S-H
7607065	DNMG332-NN	LT 10	0.031	General	P-M-K-S-H
7607069	DNMG431-NN	LT 10	0.016	Finishing	P-M-K-S-H
7607073	DNMG432-NN	LT 10	0.031	General	P-M-K-S-H
7607077	DNMG433-NN	LT 10	0.047	Roughing	P-M-K-S-H

VNMG

Part No.	Description	Grade	Radius	Operation	Material
8607241	VNMG331-NN	LT 10	0.016	Finishing	P-M-K-S-H
8607245	VNMG332-NN	LT 10	0.031	General	P-M-K-S-H

WNMG

Part No.	Description	Grade	Radius	Operation	Material
4607257	WNMG431-NN	LT 10	0.016	Finishing	P-M-K-S-H
4607261	WNMG432-NN	LT 10	0.031	General	P-M-K-S-H
4607265	WNMG433-NN	LT 10	0.047	Roughing	P-M-K-S-H

WNMP

Part No.	Description	Grade	Radius	Operation	Material
4607277	WNMP432-NN	LT 10	0.031	General	P-M-K-S-H

LT5 Inserts for Aluminum Negative Turning and Boring

CNGG

Part No.	Description	Grade	Radius	Operation	Material
6607901	CNGG431-ALU	LT 05	0.016	Finishing	N
6607905	CNGG432-ALU	LT 05	0.031	General	N

DNGG

Part No.	Description	Grade	Radius	Operation	Material
7607909	DNGG331-ALU	LT 05	0.016	Finishing	N
7607913	DNGG332-ALU	LT 05	0.031	General	N

VNGG

Part No.	Description	Grade	Radius	Operation	Material
8607921	VNGG331-ALU	LT 05	0.016	Finishing	N
8607925	VNGG332-ALU	LT 05	0.031	General	N

P = steel, M = stainless, K = cast iron, S = high temp alloys, H = hardened material, N = aluminum & alloys

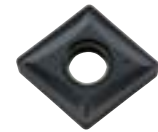
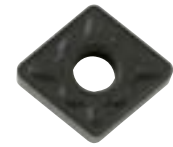

Nexus Positive Turning Toolholders

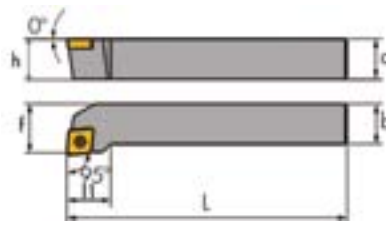

right hand shown - see table for left hand



turning & facing

SCLCR/L 95°

Part No.	Description	a=h	b	L	l1	f	Insert	Screw	Shim	Shim Screw	Wrench
8665511	SCLCR-08-3J	0.500	0.500	3.500	0.630	0.630	CC_32.5_	9317446	-	-	9355555
8665522	SCLCL-08-3J	0.500	0.500	3.500	0.630	0.630	CC_32.5_	9317446	-	-	9355555
8665533	SCLCR-12-4C	0.750	0.750	5.000	1.000	1.000	CC_43_	9319446	9333222	9319648	9355555
8665544	SCLCL-12-4C	0.750	0.750	5.000	1.000	1.000	CC_43_	9319446	9333222	9319648	9355555

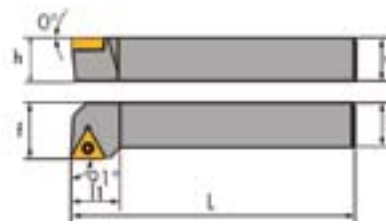

right hand shown - see table for left hand

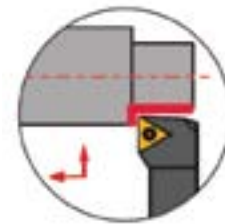

turning & facing

STGCR/L 91°

Part No.	Description	a=h	b	L	l1	f	Insert	Screw	Shim	Shim Screw	Wrench
8655512	STGCR-08-2J	0.500	0.500	3.500	0.550	0.630	TC_21.5_	9316547	-	-	9355222
8655523	STGCL-08-2J	0.500	0.500	3.500	0.550	0.630	TC_21.5_	9316547	-	-	9355222
8655534	STGCR-12-3C	0.750	0.750	5.000	0.830	1.000	TC_32.5_	9318446	9333555	9319547	9355555
8655545	STGCL-12-3C	0.750	0.750	5.000	0.830	1.000	TC_32.5_	9318446	9333555	9319547	9322126

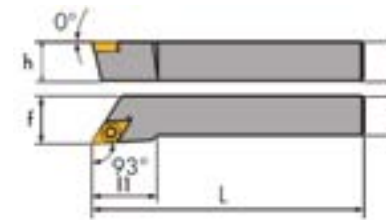

right hand shown - see table for left hand



profile turning

SDJCR/L 93°

Part No.	Description	a=h	b	L	l1	f	Insert	Screw	Shim	Shim Screw	Wrench
8675555	SDJCR-08-2J	0.500	0.500	3.500	0.600	0.630	DC_21.5_	9316547	*	*	9355222
8675566	SDJCL-08-2J	0.500	0.500	3.500	0.600	0.630	DC_21.5_	9316547	*	*	9355222
8675577	SDJCR-12-3C	0.750	0.750	5.000	0.950	1.000	DC_32.5_	9318446	9333333	9319547	9355555
8675588	SDJCL-12-3C	0.750	0.750	5.000	0.950	1.000	DC_32.5_	9318446	9333333	9319547	9322126

Nexus Positive Boring Bars – Coolant-Thru

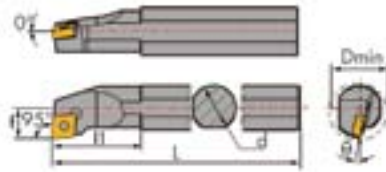

right hand shown - see table for left hand



boring & facing

SCLCR/L 95°

Part No.	Description	d	Dmin	L	l1	f	Insert	Screw	Wrench
8167711	A06H-SCLCR-2	0.375	0.472	4.00	0.551	0.236	CC_21.5_	9311455	9355222
8167722	A06H-SCLCL-2	0.375	0.472	4.00	0.551	0.236	CC_21.5_	9311455	9355222
8167733	A08K-SCLCR-2	0.500	0.630	5.00	0.984	0.354	CC_21.5_	9311455	9355222
8167744	A08K-SCLCL-2	0.500	0.630	5.00	0.984	0.354	CC_21.5_	9311455	9355222
8167755	A10M-SCLCR-3	0.625	0.787	6.00	1.280	0.433	CC_32.5_	9317446	9355555
8167766	A10M-SCLCL-3	0.625	0.787	6.00	1.280	0.433	CC_32.5_	9317446	9355555
8167777	A12Q-SCLCR-3	0.750	0.984	7.00	1.496	0.512	CC_32.5_	9317446	9355555
8167788	A12Q-SCLCL-3	0.750	0.984	7.00	1.496	0.512	CC_32.5_	9317446	9355555

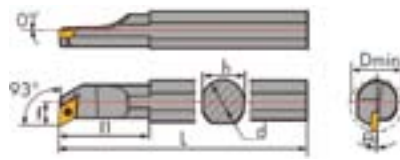

right hand shown - see table for left hand



profile boring

SDUCR/L 93°

Part No.	Description	d	Dmin	L	l1	f	Insert	Screw	Wrench
8177711	A06H-SDUCR-2	0.375	0.512	4.00	-	0.276	DC_21.5_	9311455	9355222
8177722	A06H-SDUCL-2	0.375	0.512	4.00	-	0.276	DC_21.5_	9311455	9355222
8177733	A08K-SDUCR-2	0.500	0.625	5.00	0.866	0.354	DC_21.5_	9316547	9355222
8177744	A08K-SDUCL-2	0.500	0.625	5.00	0.866	0.354	DC_21.5_	9316547	9355222
8177755	A10M-SDUCR-2	0.625	0.787	6.00	1.063	0.433	DC_21.5_	9316547	9355222
8177766	A10M-SDUCL-2	0.625	0.787	6.00	1.063	0.433	DC_21.5_	9316547	9355222
8177777	A12Q-SDUCR-3	0.750	0.984	7.00	1.575	0.512	DC_32.5_	6811259	9355555
8177788	A12Q-SDUCL-3	0.750	0.984	7.00	1.575	0.512	DC_32.5_	6811259	9355555



Nexus Boring Bars – Coolant-Thru

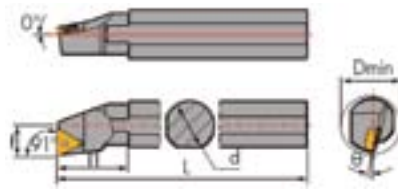

right hand shown



boring & facing

STFCR/L 91°

Part No.	Description	d	Dmin	L	l1	f	Insert	Screw	Wrench
8157711	A08K-STFCR-2	0.500	0.630	5.00	1.024	0.354	TC_ _21.5_	9316547	9355555
8157722	A10M-STFCR-2	0.625	0.787	6.00	1.181	0.434	TC_ _21.5_	9316547	9355555
8157733	A12Q-STFCR-2	0.750	0.984	7.00	1.417	0.512	TC_ _21.5_	9316547	9355555



Magia Positive Turning & Boring Inserts



NN Chipbreaker

Features

- Ultra-thick, patented PVD coating dramatically increases tool life
- Very low flank and plastic deformation minimize or eliminate offsets
- Advanced high-performance grade offers ultimate versatility
- Exceptional performance in High Temp Alloys



HIGH-PERFORMANCE
3x the Thickness of Conventional PVD!

Positive Turning and Boring Inserts

Part No.	Description	Grade	Radius	Operation	Material
3668011	CCMT21.51NN-LT1000-Insert	LT1000	0.016	Finishing	P-M-K-S-H
3668021	CCMT32.51NN-LT1000-Insert	LT1000	0.016	Finishing	P-M-K-S-H
3668026	CCMT32.52NN-LT1000-Insert	LT1000	0.031	General	P-M-K-S-H
3768811	DCMT21.51NN-LT1000-Insert	LT1000	0.016	Finishing	P-M-K-S-H
3768821	DCMT32.51NN-LT1000-Insert	LT1000	0.016	Finishing	P-M-K-S-H
3768826	DCMT32.52NN-LT1000-Insert	LT1000	0.031	General	P-M-K-S-H
3568831	TCMT21.51NN-LT1000-Insert	LT1000	0.016	Finishing	P-M-K-S-H
3568841	TCMT21.52NN-LT1000-Insert	LT1000	0.031	General	P-M-K-S-H
3568851	TCMT32.51NN-LT1000-Insert	LT1000	0.016	Finishing	P-M-K-S-H
3568861	TCMT32.52NN-LT1000-Insert	LT1000	0.031	General	P-M-K-S-H
8608831	VCMT331NN-LT1000-Insert	LT1000	0.016	Finishing	P-M-K-S-H
8608836	VCMT332NN-LT1000-Insert	LT1000	0.031	General	P-M-K-S-H

P = steel, M = stainless, K = cast iron, S = high temp alloys, H = hardened material, N = aluminum & alloys

HIGH-PERFORMANCE
3x the Thickness of Conventional PVD!

The LAMINA Difference

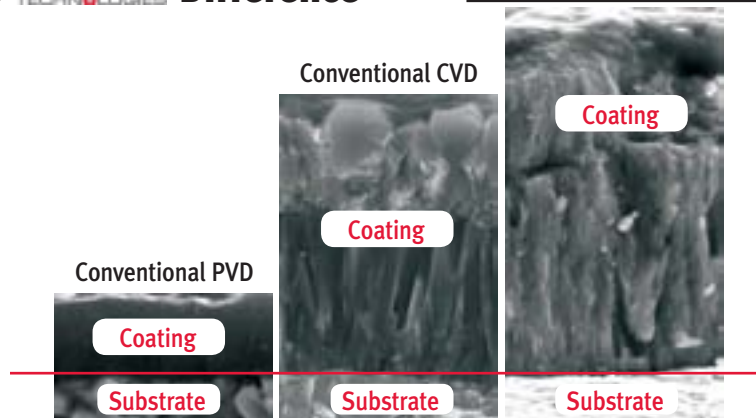

Greater Tool Life with
Magia from LAMINA

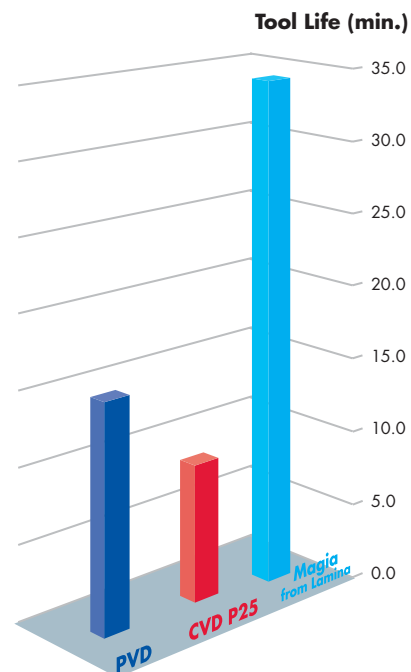

*Tech-Center test report

Positive Turning & Boring Inserts

CC__

Part No.	Description	Grade	Radius	Operation	Material
3663336	CCGX21.51-LH-Insert-101-HP	101	0.016	Finishing	N
3663337	CCGX32.51-LH-Insert-101-HP	101	0.016	Finishing	N
3663338	CCGX32.52-LH-Insert-101-HP	101	0.031	Finishing	N
3663339	CCGX432-LH-Insert-101-HP	101	0.031	Finishing	N
3668011	CCMT21.51NN-LT1000-Insert	LT1000	0.016	Finishing	P-M-K-S-H
3664411	CCMT21.51NN-LT10-Insert	LT10	0.016	General	P-M-K-S-H
3668021	CCMT32.51NN-LT1000-Insert	LT1000	0.016	Finishing	P-M-K-S-H
3664413	CCMT32.51NN-LT10-Insert	LT10	0.016	General	P-M-K-S-H
3668026	CCMT32.52NN-LT1000-Insert	LT1000	0.031	General	P-M-K-S-H
3664416	CCMT32.52NN-LT10-Insert	LT10	0.031	General	P-M-K-S-H
3664419	CCMT32.52WM-LT 10-Insert	LT10	0.031	General	P-M-K-S-H

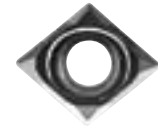

CCGX



CCMT

DC__

Part No.	Description	Grade	Radius	Operation	Material
3763336	DCGX21.51-LH-Insert-101-HP	101	0.016	Finishing	N
3763337	DCGX32.52-LH-Insert-101-HP	101	0.031	Finishing	N
3768811	DCMT21.51NN-LT1000-Insert	LT1000	0.016	Finishing	P-M-K-S-H
3764421	DCMT21.51NN-LT10-Insert	LT10	0.016	Finishing	P-M-K-S-H
3768821	DCMT32.51NN-LT1000-Insert	LT1000	0.016	Finishing	P-M-K-S-H
3764424	DCMT32.51NN-LT10-Insert	LT10	0.016	Finishing	P-M-K-S-H
3768826	DCMT32.52NN-LT1000-Insert	LT1000	0.031	General	P-M-K-S-H
3764427	DCMT32.52NN-LT10-Insert	LT10	0.031	General	P-M-K-S-H
3732040	DCMT432PM4-Insert-5615	5615	0.031	General	P-M-K-S-H



DCMT

TC__

Part No.	Description	Grade	Radius	Operation	Material
3563336	TCGX21.51-LH-Insert-101-HP	101	0.016	Finishing	N
3563337	TCGX32.52-LH-Insert-101-HP	101	0.031	Finishing	N
3533010	TCMT1.2(1).5PF4-Insert-5615	5615	0.016	General	P-M-K-S-H
3533020	TCMT1.2(1)1PF4-Insert-5625	5625	0.016	Finishing	P-M-K-S-H
3533030	TCMT1.8(1.5)1PF4-Insert-5625	5625	0.016	Finishing	P-M-K-S-H
3568831	TCMT21.51NN-LT1000-Insert	LT1000	0.016	Finishing	P-M-K-S-H
3564431	TCMT21.51NN-LT10-Insert	LT10	0.016	Finishing	P-M-K-S-H
3568841	TCMT21.52NN-LT1000-Insert	LT1000	0.031	General	P-M-K-S-H
3564435	TCMT21.52NN-LT10-Insert	LT10	0.031	General	P-M-K-S-H
3568851	TCMT32.51NN-LT1000-Insert	LT1000	0.016	Finishing	P-M-K-S-H
3564438	TCMT32.51NN-LT10-Insert	LT10	0.016	General	P-M-K-S-H
3568861	TCMT32.52NN-LT1000-Insert	LT1000	0.031	General	P-M-K-S-H
3564441	TCMT32.52NN-LT10-Insert	LT10	0.031	General	P-M-K-S-H
3533090	TCMT32.52PM4-Insert-5625	5625	0.031	General	P-M-K-S-H



TCGX



TCMT

V_MT

Part No.	Description	Grade	Radius	Operation	Material
3862215	VBMT221NN-LT10-Insert	LT10	0.016	General	P-M-K-S-H
3862221	VBMT331NN-LT10-Insert	LT10	0.016	Finishing	P-M-K-S-H
3862225	VBMT332NN-LT10-Insert	LT10	0.031	General	P-M-K-S-H
8608831	VCMT331NN-LT1000-Insert	LT1000	0.016	Finishing	P-M-K-S-H
8608836	VCMT332NN-LT1000-Insert	LT1000	0.031	General	P-M-K-S-H



VBMT

P = steel, M = stainless, K = cast iron, S = high temp alloys, H = hardened material, N = aluminum & alloys

Machining Guide for Turning

LAMINA
TECHNOLOGIES

HIGH-PERFORMANCE

Material Group	No.	Material Examples	hardness BHn	Nose radius 1/64" (04)		Nose radius 2/64" (08)		Nose radius 3/64" (12)		Initial SFM	
				d.o.c	f	d.o.c	f	d.o.c	f		
Low Carbon Steel	1	1018 / 1020	150	0.015	0.004	0.030	0.009	0.040	0.012	1300	
		1026 / 12414	180	to	to	to	to	to	to	975	
		1045	210	0.060	0.006	0.125	0.011	0.200	0.020	825	
Alloy Steel	2	8620	180	0.015	0.004	0.030	0.009	0.040	0.012	1000	
		4140	230	to	to	to	to	to	to	800	
		4340	280	0.060	0.005	0.125	0.011	0.157	0.018	675	
		52100	320							550	
High Alloy Steel	3	ASTM A353	220	0.015	0.004	0.030	0.008	0.040	0.013	525	
			280	to		to	to	to	400		
		H13	320	0.060		0.125	0.010	0.125	0.018	350	
			350							300	
Austenitic Stainless Steel	4	303 / 304 304 L	210 to 250	0.015 to 0.060	0.005 to 0.006	0.030 to 0.125	0.007 to 0.012	0.040 to 0.200	0.012 to 0.020	700	
		5	316 / 316 L	230 to 270	0.015 to 0.060	0.004 to 0.006	0.030 to 0.125	0.007 to 0.010	0.040 to 0.157	0.011 to 0.018	600
		6	i316 T 630 (F16PH)	230 to 270	0.015 to 0.050	0.005	0.030 to 0.125	0.007 to 0.010	0.040 to 0.125	0.011 to 0.018	350
Ferritic Stainless Steel	7	430 / 439 / 444	200 to 300	0.015 to 0.060	0.005 to 0.006	0.030 to 0.125	0.009 to 0.011	0.030 to 0.157	0.012 to 0.018	600	
Martensitic Stainless Steel	8	410 / 420	200 to 300	0.015 to 0.060	0.005 to 0.006	0.030 to 0.125	0.009 to 0.011	0.030 to 0.157	0.012 to 0.018	600 450	
Grey Cast Iron	9	Class 20	140 to 250	0.008	0.003	0.030	0.007	0.030	0.012	750	
		Class 30		to	to	to	to	to	to	700	
		Class 40		0.060	0.006	0.187	0.014	0.200	0.024	625	
Nodular Cast Iron	10	60-40-18	210	0.008	0.004	0.030	0.007	0.030	0.012	625	
		80-55-06	260	to	to	to	to	to	to	550	
		1000-70-03	310	0.060	0.005	0.125	0.012	0.200	0.020	450	
Nickel Based Alloys	11	Inconel 625	—	0.009	0.004	0.030	0.007	0.030	0.012	100	
		Inconel 718		to	to	to	to	to	to	115	
		Hastelloy C		0.047	0.005	0.125	0.011	0.125	0.017	200	
Titanium Based Alloys	12	TiAl 6 V4	—	0.009 to 0.047	0.004 to 0.006	0.030 to 0.125	0.007 to 0.012	0.030 to 0.157	0.012 to 0.018	165 125	
		T40									
Aluminum	13	Si < 4%	—	0.008 to	0.005 to	0.008 to	0.006 to			2400	
Aluminum		4% < Si < 9%	—	0.200	0.010	0.200	0.020			1350	
				For Alu group 13, please use our Alu line grade LT-05							
Aluminum	14	Si > 9%	—	0.020-0.200	0.003-0.009	0.020-0.200	0.007-0.016	0.020-0.200	0.009-0.024	750	
				For Alu group 14, please use inserts grade LT-10							

Nexus Turning & Boring Tools and Inserts



All Nexus Tool products are backed by our 100% satisfaction guarantee.

Master List of Turning & Boring Inserts

Part No.	Description	Grade	Radius	Operation	Material
3663336	CCGX21.51-LH-Insert-101-HP	101	0.016	Finishing	N
3663337	CCGX32.51-LH-Insert-101-HP	101	0.016	Finishing	N
3663338	CCGX32.52-LH-Insert-101-HP	101	0.031	Finishing	N
3663339	CCGX432-LH-Insert-101-HP	101	0.031	Finishing	N
3668011	CCMT21.51NN-LT1000-Insert	LT1000	0.016	Finishing	P-M-K-S-H
3664411	CCMT21.51NN-LT10-Insert	LT10	0.016	General	P-M-K-S-H
3668021	CCMT32.51NN-LT1000-Insert	LT1000	0.016	Finishing	P-M-K-S-H
3664413	CCMT32.51NN-LT10-Insert	LT10	0.016	General	P-M-K-S-H
3668026	CCMT32.52NN-LT1000-Insert	LT1000	0.031	General	P-M-K-S-H
3664416	CCMT32.52NN-LT10-Insert	LT10	0.031	General	P-M-K-S-H
3664419	CCMT32.52WM-LT 10-Insert	LT10	0.031	General	P-M-K-S-H
6607901	CNGG431-ALU-LT05-Insert	LT05	0.016	Finishing	N-S
6607905	CNGG432-ALU-LT05-Insert	LT05	0.031	General	N-S
6608011	CNMG431NN-LT1000-Insert	LT1000	0.016	Finishing	P-M-K-S-H
6607029	CNMG431NN-LT10-Insert	LT10	0.016	General	P-M-K-S-H
6608016	CNMG432NN-LT1000-Insert	LT1000	0.031	General	P-M-K-S-H
6607033	CNMG432NN-LT10-Insert	LT10	0.031	General	P-M-K-S-H
6601436	CNMG432NR-LT10-Insert	LT10	0.031	General	P-M-K-S-H
6608026	CNMG432NX-LT1000-Insert	LT1000	0.031	General	P-M-K-S-H
6600060	CNMG432WM-LT10-Insert	LT10	0.031	General	P-M-K-S-H
6607041	CNMG432WM-LT10-Insert	LT10	0.031	General	P-M-K-S-H
6608021	CNMG433NN-LT1000-Insert	LT1000	0.047	Roughing	P-M-K-S-H
6607037	CNMG433NN-LT10-Insert	LT10	0.047	General	P-M-K-S-H
6608031	CNMP432NN-LT1000-Insert	LT1000	0.031	General	P-M-K-S-H
6607045	CNMP432NN-LT10-Insert	LT10	0.031	General	P-M-K-S-H
6608036	CNMP433NN-LT1000-Insert	LT1000	0.047	Roughing	P-M-K-S-H
3665525	CNMP433NN-LT10-Insert	LT10	0.047	General	P-M-K-S-H
3763336	DCGX21.51-LH-Insert-101-HP	101	0.016	Finishing	N
3763337	DCGX32.52-LH-Insert-101-HP	101	0.031	Finishing	N
3768811	DCMT21.51NN-LT1000-Insert	LT1000	0.016	Finishing	P-M-K-S-H
3764421	DCMT21.51NN-LT10-Insert	LT10	0.016	Finishing	P-M-K-S-H
3768821	DCMT32.51NN-LT1000-Insert	LT1000	0.016	Finishing	P-M-K-S-H
3764424	DCMT32.51NN-LT10-Insert	LT10	0.016	Finishing	P-M-K-S-H
3768826	DCMT32.52NN-LT1000-Insert	LT1000	0.031	General	P-M-K-S-H
3764427	DCMT32.52NN-LT10-Insert	LT10	0.031	General	P-M-K-S-H
3732040	DCMT432PM4-Insert-5615	5615	0.031	General	P-M-K-S-H
7607909	DNGG331-ALU-LT05-Insert	LT05	0.016	Finishing	N-S
7607913	DNGG332-ALU-LT05-Insert	LT05	0.031	General	N-S
7608011	DNMG331NN-LT1000-Insert	LT1000	0.016	Finishing	P-M-K-S-H



CCGX



CCMT



CNMG



DCMT



DNGG

P = steel, M = stainless, K = cast iron, S = high temp alloys, H = hardened material, N = aluminum & alloys

Master List of Turning & Boring Inserts

Part No.	Description	Grade	Radius	Operation	Material
7607061	DNMG331NN-LT10-Insert	LT10	0.016	General	P-M-K-S-H
7608016	DNMG332NN-LT1000-Insert	LT1000	0.031	General	P-M-K-S-H
7607065	DNMG332NN-LT10-Insert	LT10	0.031	General	P-M-K-S-H
7608021	DNMG431NN-LT1000-Insert	LT1000	0.016	Finishing	P-M-K-S-H
7607069	DNMG431NN-LT10-Insert	LT10	0.016	Finishing	P-M-K-S-H
7608026	DNMG432NN-LT1000-Insert	LT1000	0.031	General	P-M-K-S-H
7607073	DNMG432NN-LT10-Insert	LT10	0.031	General	P-M-K-S-H
7608031	DNMG433NN-LT1000-Insert	LT1000	0.047	Roughing	P-M-K-S-H
7607077	DNMG433NN-LT10-Insert	LT10	0.047	Roughing	P-M-K-S-H
3263311	SNMG432NN-LT10-Insert	LT30	0.031	General	P-M-K-S-H
3263322	SNMG433NN-LT10-Insert	LT30	0.047	General	P-M-K-S-H
3563336	TCGX21.51-LH-Insert-101-HP	101	0.016	Finishing	N
3563337	TCGX32.52-LH-Insert-101-HP	101	0.031	Finishing	N
3533010	TCMT1.2(1).5PF4-Insert-5615	5615	0.016	General	P-M-K-S-H
3533020	TCMT1.2(1)1PF4-Insert-5625	5625	0.016	Finishing	P-M-K-S-H
3533030	TCMT1.8(1.5)1PF4-Insert-5625	5625	0.016	Finishing	P-M-K-S-H
3568831	TCMT21.51NN-LT1000-Insert	LT1000	0.016	Finishing	P-M-K-S-H
3564431	TCMT21.51NN-LT10-Insert	LT10	0.016	Finishing	P-M-K-S-H
3568841	TCMT21.52NN-LT1000-Insert	LT1000	0.031	General	P-M-K-S-H
3564435	TCMT21.52NN-LT10-Insert	LT10	0.031	General	P-M-K-S-H
3568851	TCMT32.51NN-LT1000-Insert	LT1000	0.016	Finishing	P-M-K-S-H
3564438	TCMT32.51NN-LT10-Insert	LT10	0.016	General	P-M-K-S-H
3568861	TCMT32.52NN-LT1000-Insert	LT1000	0.031	General	P-M-K-S-H
3564441	TCMT32.52NN-LT10-Insert	LT10	0.031	General	P-M-K-S-H
3533090	TCMT32.52PM4-Insert-5625	5625	0.031	General	P-M-K-S-H
3567711	TNGG331-ALU-LT05-Insert	LT05	0.016	Finishing	N-S
3578011	TNMG331NN-LT1000-Insert	LT1000	0.016	Finishing	P-M-K-S-H
3577715	TNMG331NN-LT10-Insert	LT10	0.016	Finishing	P-M-K-S-H
3578016	TNMG332NN-LT1000-Insert	LT1000	0.031	General	P-M-K-S-H
3567721	TNMG332NN-LT10-Insert	LT10	0.031	General	P-M-K-S-H
3578021	TNMG333NN-LT1000-Insert	LT1000	0.047	Roughing	P-M-K-S-H
3578026	TNMP332NN-LT1000-Insert	LT1000	0.031	General	P-M-K-S-H
3567735	TNMP332NN-LT10-Insert	LT10	0.031	General	P-M-K-S-H
3862215	VBMT221NN-LT10-Insert	LT10	0.016	General	P-M-K-S-H
3862221	VBMT331NN-LT10-Insert	LT10	0.016	Finishing	P-M-K-S-H
3862225	VBMT332NN-LT10-Insert	LT10	0.031	General	P-M-K-S-H
8608831	VCMT331NN-LT1000-Insert	LT1000	0.016	Finishing	P-M-K-S-H
8608836	VCMT332NN-LT1000-Insert	LT1000	0.031	General	P-M-K-S-H
8607921	VNGG331-ALU-LT05-Insert	LT05	0.016	Finishing	N-S



TCGX



VNGG

P = steel, M = stainless, K = cast iron, S = high temp alloys, H = hardened material, N = aluminum & alloys

Master List of Turning & Boring Inserts

Part No.	Description	Grade	Radius	Operation	Material
8607925	VNGG332-ALU-LT05-Insert	LT05	0.031	General	N-S
8608011	VNMG331NN-LT1000-Insert	LT1000	0.016	Finishing	P-M-K-S-H
8607241	VNMG331NN-LT10-Insert	LT10	0.016	Finishing	P-M-K-S-H
8608016	VNMG332NN-LT1000-Insert	LT1000	0.031	General	P-M-K-S-H
8607245	VNMG332NN-LT10-Insert	LT10	0.031	General	P-M-K-S-H
3463311	WNMG331NN-LT10-Insert	LT10	0.016	Finishing	P-M-K-S-H
3463315	WNMG332NN-LT10-Insert	LT10	0.031	General	P-M-K-S-H
4608011	WNMG431NN-LT1000-Insert	LT1000	0.016	Finishing	P-M-K-S-H
4607257	WNMG431NN-LT10-Insert	LT10	0.016	General	P-M-K-S-H
3463321	WNMG432NN-LT1000 Magia Insert	LT1000	0.031	General	P-M-K-S-H
4608016	WNMG432NN-LT1000-Insert	LT1000	0.031	General	P-M-K-S-H
4607261	WNMG432NN-LT10-Insert	LT10	0.031	General	P-M-K-S-H
4601437	WNMG432NR-LT10-Insert	LT10	0.031	General	P-M-K-S-H
4608021	WNMG432NX-LT1000-Insert	LT1000	0.031	General	P-M-K-S-H
4600076	WNMG432WM-LT10-Insert	LT10	0.031	General	P-M-K-S-H
4608026	WNMG433NN-LT1000-Insert	LT1000	0.047	Roughing	P-M-K-S-H
4607265	WNMG433NN-LT10-Insert	LT10	0.047	Roughing	P-M-K-S-H
4608031	WNMP432NN-LT1000-Insert	LT1000	0.031	General	P-M-K-S-H
4607277	WNMP432NN-LT10-Insert	LT10	0.031	General	P-M-K-S-H



WNMG

P = steel, M = stainless, K = cast iron, S = high temp alloys, H = hardened material, N = aluminum & alloys

Lamina Inserts Machining Guide

As a new user of the revolutionary Lamina inserts, we would like to present to you a short machining guide to insure your satisfaction with our product. The cutting data specified in this guide should be considered as a good starting point. Each insert is able to perform in a wider range of cutting conditions.

Turning (See Machining Guide on page 257)

1. Select the material group to be machined.
2. Select the insert nose radius.
3. Select cutting depth and feed according to radius.
4. The cutting speed is indicated in the right-hand column.

Turning Tips

- The cutting conditions are Nexus Tool guidelines for optimal machining, however our inserts can work in a wider range of cutting conditions to meet special machining needs.
- According to our recommended cutting conditions, A-max should be used for optimum results.

- When machining stainless steel, make sure your speed is over the minimum requirement. Stainless steel can be gummy. Running it too slowly can cause gaulding (weldment of the chip to the insert).
- Coolant recommendations:
Use coolant with materials from groups 6, 7, 8, 9, 10, 11, 12. Do not use coolant with materials from groups 1, 2, 4. Use coolant with materials from groups 3, 5 — depending on the application.
- Always verify that the toolholder and shim are in good condition (not damaged).
- If chips are too long, we recommend increasing feed rate.
- If chips are not controlled (vary in shape and size), we recommend increasing feed rate and reducing depth of cut.
- For the internal boring operations, the toolholder should be as short as possible and shank as big as possible.
- In the case of chatter, we recommend reducing cutting speed, and increasing feed rate.
- Reduce the feed rate for heavy interrupted cuts.

Formulas & Conversions

Definition

Formula

Inches Per Tooth (IPT or Chip Load)

The thickness of material that is removed by one tooth in one complete revolution.

Inches Per Revolution (IPR)

The linear distance that a tool advances in one complete revolution.

$$\text{IPR} = \text{IPT} \times \text{NUMBER OF TEETH}$$

Inches Per Minute (IPM)

The linear distance, in inches, that the tool advances in one minute.

$$\text{IPM} = \text{IPR} \times \text{RPM}$$

Surface Feet Per Minute (SFPM)

The linear distance, in feet, that the cutting edge of the tool travels in one minute.

$$\text{SFPM} = \frac{\text{RPM} \times \text{DIA}}{3.82}$$

Revolutions Per Minute (RPM)

The number of times a tool rotates 360° in one minute.

$$\text{RPM} = \frac{\text{SFPM} \times 3.82}{\text{DIA}}$$

Meters Per Minute (M/MIN)

The linear distance, in meters, that the cutting edge of the tool travels in one minute.

$$\text{M/M} = \text{RPM} \times .003 \times \text{DIA}$$

Convert Millimeters to Inches

$$\text{INCHES} = \frac{\text{MM}}{25.4}$$

Convert Inches to Millimeters

$$\text{MM} = \text{INCHES} \times 25.4$$

Convert Meters Per Minute to Surface Feet Per Minute

$$\text{SFPM} = \text{M/M} \times 3.3$$

Convert Surface Feet Per Minute to Meters Per Minute

$$\text{MM} = \frac{\text{SFPM}}{3.3}$$

Depth Of Cut (DOC)

The amount of material removed, in thickness, by one pass of the cutting tool.

Metal Removal Rate ("Q" or IN³/MIN).

The amount of cubic inches of material removed in one minute.

$$\text{Q} = \text{DOC} \times \text{WOC} \times \text{IPM}$$

Nexus Products by Part Number (1500300 - 3254411)

Part No.	Description
1500300	APKT160424ER-LT30-Insert
1501567	APLX100340PDTR-LT30-Insert
1506065	ADKT1505PDTR-LT30-Insert
1506073	APKT1604 PDTR-LT30-Insert
1506077	APKT1705PETR-LT30-Insert
1506082	APLX1003PDTR-LT30-Insert
1506085	APLX100308PDTR-LT 30-Insert
1506501	APGT1003PDER-ALU-LT05-Insert
1506505	APGT1604PDER-ALU-LT05-Insert
1631234	IEM90-.500-.500-4.00-1-10 (1/2")
1632234	IEM90-.500-.500C-4.00-1-10 (1/2"-CT-H13)
1632345	PLIM.500-.500-4.00-1-10 (1/2")
1633345	PLIM.500-.500C-4.00-1-10 (1/2"-CT-H13)
1641235	IEM90-.625-.625-5.00-2-10 (5/8")
1642235	IEM90-.625-.625C-5.00-2-10 (5/8"-CT-H13)
1651236	IEM90-.750-.750-5.00-2-10 (3/4")
1652236	IEM90-.750-.750C-5.00-2-10 (3/4"-CT-H13)
1654345	PLIM.750-.750-5.00-2-10 (3/4")
1655345	PLIM.750-.750C-5.00-2-10 (3/4"-CT-H13))
1658810	HFEM-0.75-0.75-WP05-02 (3/4"-CT)
1661237	IEM90-1.00-1.00-6.00-3-10 (1")
1662237	IEM90-1.00-1.00C-6.00-3-10 (1"-CT-H13)
1665345	PLIM1.00-1.00-6.00-3-10 (1")
1666345	PLIM1.00-1.00C-6.00-3-10 (1"-CT-H13))
1668820	HFEM-1.00-1.00-5.50-SD09-02 (1"-CT)
1668822	HFEM-1.00-1.00-7.00-SD09-02 (1"-CT)
1671238	IEM90-1.25-1.25-6.00-3-16 (1-1/4")
1672238	IEM90-1.25-1.25C-6.00-3-16 (1-1/4"-CT-H13)
1678830	HFEM-1.25-1.25-8.00-SD09-03 (1-1/4"-CT)
1678840	HFEM-1.25-1.25-8.00-SD12-02 (1-1/4"-CT)
1682239	IEM90-1.50-1.25C-6.00-4-16 (1-1/2"-CT-H13)
1686239	IEM90-1.50-1.25-6.00-4-16 (1-1/2")
1688850	HFEM-1.50-1.50-8.00-SD12-03 (1-1/2"-CT)
1741234	4WD.625-.750C-2.50-3 (5/8"-D-RH)
1751244	4WD.750-.750C-3.00-3 (3/4"-D-RH)
1751254	4WD.875-1.00C-3.50-4 (7/8"-D-RH)
1751394	4WD2.25-1.50C-9.00-8 (2-1/4"-D-RH)
1761264	4WD1.00-1.00C-4.00-4 (1"-D-RH)
1771284	4WD1.25-1.25C-5.00-6 (1-1/4"-D-RH)
1771294	4WD1.375-1.25C-5.50-6 (1-3/8"-D-RH)
1781334	4WD1.50-1.25C-6.00-6 (1-1/2"-D-RH)
1781354	4WD1.75-1.50C-7.00-6 (1-3/4"-D-RH)

Part No.	Description
1781374	4WD2.00-1.50C-8.00-8 (2"-D-RH)
2139910	PN11-3.00-1.00-08 (3"-FM)
2149920	PN11-4.00-1.25-10 (4"-FM)
2159930	PN11-5.00-1.50-12 (5"-FM)
2169940	PN11-6.00-1.50-14 (6"-FM)
2321234	SFM90-2.00C-.750-4-16 (2"-CT)
2331235	SFM90-3.00C-1.25-6-16 (3"-CT)
2341236	SFM90-4.00C-1.25-7-16 (4"-CT)
2351237	SFM90-5.00C-1.50-8-16 5"-CT)
2421234	SFM45-2.00C-.750-4-13 (2"-CT)
2431235	SFM45-3.00C-1.25-6-13 (3"-CT)
2441236	SFM45-4.00C-1.25-7-13 (4"-CT)
2451237	SFM45-5.00C-1.50-8-13 (5"-CT)
2502115	SNKX09T3HF-LT30-Insert
2506169	SEKT12T3AGTN-LT30-Insert
2506509	SEGT1204AFEN-ALU-LT05-Insert
2521234	FM45-2.00C-.750-4-13 (2"-CT)
2531235	FM45-3.00C-1.25-6-13 (3"-CT)
2541236	FM45-4.00C-1.25-7-13 (4"-CT)
2551237	FM45-5.00C-1.50-8-13 (5"-CT)
2621234	FM90-2.00C-.750-4-16 (2"-CT)
2631235	FM90-3.00C-1.25-6-16 (3"-CT)
2641236	FM90-4.00C-1.25-7-16 (4"-CT)
2651237	FM90-5.00C-1.50-8-16 (5"-CT)
2928860	HFM-2.00-0.75-SD09-04 (2"-CT)
2928865	HFM-2.50-0.75-SD09-05 (2-1/2"-CT)
2938870	HFM-3.00-1.25-SD12-05 (3"-CT)
3151236	APEX100304PDRF-F01-Insert-5005-HP
3151239	APEX1604PDRF-F01-Insert-GH05-HP
3153311	AOMT123608PETR-LT30-Insert
3153321	APMT1135PDTR-LT30-Insert
3153325	APMT160408PDTR-LT30-Insert
3154411	APKT1003PDTR-LT30-Insert
3154422	APKT 100304 PDTR LT30-Insert
3154433	APKT 100312 PDTR LT30-Insert
3154444	APKT 100332 PDTR LT30-Insert
3154455	APKT 100340 PDTR LT30-Insert
3251239	SEET13T3-LH-Insert-WSK10-HP
3253310	SDMT09T312-DM-Insert-202 (HF)
3253320	SDMT120412-DM-Insert-202 (HF)
3254411	SDKT1204AETN-LT30-Insert

Nexus Products by Part Number (3254415 - 3862221)

Part No.	Description
3254415	SEKN1203AFTN-LT30-Insert
3254431	SEKR1203AFTN-LT30-Insert
3254435	SEKT1204AFTN-LT30-Insert
3263311	SNMG432NN-LT10-Insert
3263322	SNMG433NN-LT10-Insert
3355525	RCMT1204M0-LT10-Insert
3355531	RDMT0803M0-LT30-Insert
3355541	RDMT1204M0-LT30-Insert
3441111	WCMX030208-Drill Insert
3441121	WCMX040208NN-LT30-Drill Insert
3441125	WCMX050308NN-LT30-Drill Insert
3441131	WCMX06T308NN-LT30-Drill Insert
3441135	WCMX080412NN-LT30-Drill Insert
3451112	WPGT050315ZSR-Insert-351-HF
3463311	WNMG331NN-LT10-Insert
3463315	WNMG332NN-LT10-Insert
3463321	WNMG432NN-LT1000 Magia Insert
3533010	TCMT1.2(1).5PF4-Insert-5615
3533020	TCMT1.2(1)1PF4-Insert-5625
3533030	TCMT1.8(1.5)1PF4-Insert-5625
3533070	TCMT32.51PF4-Insert-5625
3533080	TCMT32.52PF4-Insert-5625
3533090	TCMT32.52PM4-Insert-5625
3563336	TCGX21.51-LH-Insert-101-HP
3563337	TCGX32.52-LH-Insert-101-HP
3564431	TCMT21.51NN-LT10-Insert
3564435	TCMT21.52NN-LT10-Insert
3564438	TCMT32.51NN-LT10-Insert
3564441	TCMT32.52NN-LT10-Insert
3567711	TNGG331-ALU-LT05-Insert
3567721	TNMG332NN-LT10-Insert
3567735	TNMP332NN-LT10-Insert
3567741	TPKN32PDTR-LT30-Insert
3567745	TPKN43PDTR-LT30-Insert
3567751	TPKR323PDTR-LT30-Insert
3567755	TPKR43PDTR-LT30-Insert
3567761	TPUN322-LT30-Insert
3568831	TCMT21.51NN-LT1000-Insert
3568841	TCMT21.52NN-LT1000-Insert
3568851	TCMT32.51NN-LT1000-Insert

Part No.	Description
3568861	TCMT32.52NN-LT1000-Insert
3577715	TNMG331NN-LT10-Insert
3578011	TNMG331NN-LT1000-Insert
3578016	TNMG332NN-LT1000-Insert
3578021	TNMG333NN-LT1000-Insert
3578026	TNMP332NN-LT1000-Insert
3631040	CCMT32.51-PF4-Insert-5625
3631050	CCMT32.52-PF4-Insert-5625
3631060	CCMT32.52-PM5-Insert-5625
3631070	CCMT431-PM5-Insert-5625
3631080	CCMT432-PM5-Insert-5625
3631090	CNMG431F4-Insert-5625
3631093	CNMG432F4-Insert-5625
3631095	CNMG432M5-Insert-5625
3663336	CCGX21.51-LH-Insert-101-HP
3663337	CCGX32.51-LH-Insert-101-HP
3663338	CCGX32.52-LH-Insert-101-HP
3663339	CCGX432-LH-Insert-101-HP
3664411	CCMT21.51NN-LT10-Insert
3664413	CCMT32.51NN-LT10-Insert
3664416	CCMT32.52NN-LT10-Insert
3664419	CCMT32.52WM-LT 10-Insert
3665525	CNMP433NN-LT10-Insert
3668011	CCMT21.51NN-LT1000-Insert
3668021	CCMT32.51NN-LT1000-Insert
3668026	CCMT32.52NN-LT1000-Insert
3732010	DCMT32.51PF4-Insert-5625
3732020	DCMT32.52PF4-Insert-5625
3732030	DCMT32.51PM4-Insert-5625
3732040	DCMT432PM4-Insert-5615
3763336	DCGX21.51-LH-Insert-101-HP
3763337	DCGX32.52-LH-Insert-101-HP
3764421	DCMT21.51NN-LT10-Insert
3764424	DCMT32.51NN-LT10-Insert
3764427	DCMT32.52NN-LT10-Insert
3768811	DCMT21.51NN-LT1000-Insert
3768821	DCMT32.51NN-LT1000-Insert
3768826	DCMT32.52NN-LT1000-Insert
3862215	VBMT22NN-LT10-Insert
3862221	VBMT331NN-LT10-Insert

Nexus Products by Part Number (3862225 - 8177766)

Part No.	Description
3862225	VBMT332NN-LT10-Insert
3934020	EPGT 1.2(1).5L-W08-Insert-NS530
3934030	EPMT 1.5(3).5-PM5-Insert-5625
3954411	ODMT060508TN-LT30-Insert
3954415	ODMW060508TN-LT30-Insert
3954421	OFER070405TN-LT30-Insert
3954431	OFMT05T305TN-LT30-Insert
3954435	OFMT070405TN-LT30-Insert
3959999	PNEG110512R-CM-Insert-152
4600076	WNMG432WM-LT10-Insert
4601437	WNMG432NR-LT10-Insert
4607257	WNMG431NN-LT10-Insert
4607261	WNMG432NN-LT10-Insert
4607265	WNMG433NN-LT10-Insert
4607277	WNMP432NN-LT10-Insert
4608011	WNMG431NN-LT1000-Insert
4608016	WNMG432NN-LT1000-Insert
4608021	WNMG432NX-LT1000-Insert
4608026	WNMG433NN-LT1000-Insert
4608031	WNMP432NN-LT1000-Insert
6600060	CNMG432WM-LT10-Insert
6601436	CNMG432NR-LT10-Insert
6602117	HFEM-1.00-1.00CW-8.00-2SN9 (1"-CT-W)
6602118	HFEM-1.00-1.00CW-5.00-3SN9 (1"-CT-W)
6607029	CNMG431NN-LT10-Insert
6607033	CNMG432NN-LT10-Insert
6607037	CNMG433NN-LT10-Insert
6607041	CNMG432WM-LT10-Insert
6607045	CNMP432NN-LT10-Insert
6607901	CNGG431-ALU-LT05-Insert
6607905	CNGG432-ALU-LT05-Insert
6608011	CNMG431NN-LT1000-Insert
6608016	CNMG432NN-LT1000-Insert
6608021	CNMG433NN-LT1000-Insert
6608026	CNMG432NX-LT1000-Insert
6608031	CNMP432NN-LT1000-Insert
6608036	CNMP433NN-LT1000-Insert
6612117	PLHF-1.00-1.00C-8.00-2SN9 (1"-CT)
6612118	PLHF-1.00-1.00C-5.00-3SN9 (1"-CT)
6702119	HFEM-1.25-1.25CW-5.00-4SN9 (1-1/4"-CT-W)

Part No.	Description
6702120	HFEM-1.25-1.25CW-8.00-3SN9 (1-1/4"-CT-W)
6712119	PLHF-1.25-1.25C-5.00-4SN9 (1-1/4"-CT)
6712120	PLHF-1.25-1.25C-8.00-3SN9 (1-1/4"-CT)
7607061	DNMG331NN-LT10-Insert
7607065	DNMG332NN-LT10-Insert
7607069	DNMG431NN-LT10-Insert
7607073	DNMG432NN-LT10-Insert
7607077	DNMG433NN-LT10-Insert
7607909	DNGG331-ALU-LT05-Insert
7607913	DNGG332-ALU-LT05-Insert
7608011	DNMG331NN-LT1000-Insert
7608016	DNMG332NN-LT1000-Insert
7608021	DNMG431NN-LT1000-Insert
7608026	DNMG432NN-LT1000-Insert
7608031	DNMG433NN-LT1000-Insert
8148871	A16T-PWLN-4 (1"-S-BB-CT-RH)
8148872	A20T-PWLN-4 (1-1/4"-S-BB-CT-RH)
8157711	A08K-STFCR-2 (1/2"-S-BB-CT-RH)
8157722	A10M-STFCR-2 (5/8"-S-BB-CT-RH)
8157733	A12Q-STFCR-2 (3/4"-S-BB-CT-RH)
8167711	A06H-SCLCR-2 (3/8"-S-BB-CT-RH)
8167722	A06H-SCLCL-2 (3/8"-S-BB-CT-LH)
8167733	A08K-SCLCR-2 (1/2"-S-BB-CT-RH)
8167744	A08K-SCLCL-2 (1/2"-S-BB-CT-LH)
8167755	A10M-SCLCR-3 (5/8"-S-BB-CT-RH)
8167766	A10M-SCLCL-3 (5/8"-S-BB-CT-LH)
8167777	A12Q-SCLCR-3 (3/4"-S-BB-CT-RH)
8167788	A12Q-SCLCL-3 (3/4"-S-BB-CT-LH)
8168811	A16T-PCLNR-4 (1"-S-BB-CT-RH)
8168812	A20T-PCLNR-4 (1-1/4"-S-BB-CT-RH)
8168813	A24U-PCLNR-4 (1-1/2"-S-BB-CT-RH)
8168821	A16T-PCLNL-4 (1"-S-BB-CT-LH)
8168822	A20T-PCLNL-4 (1-1/4"-S-BB-CT-LH)
8168823	A24U-PCLNL-4 (1-1/2"-S-BB-CT-LH)
8177711	A06H-SDUCR-2 (3/8"-S-BB-CT-RH)
8177722	A06H-SDUCL-2 (3/8"-S-BB-CT-LH)
8177733	A08K-SDUCR-2 (1/2"-S-BB-CT-RH)
8177744	A08K-SDUCL-2 (1/2"-S-BB-CT-LH)
8177755	A10M-SDUCR-2 (5/8"-S-BB-CT-RH)
8177766	A10M-SDUCL-2 (5/8"-S-BB-CT-LH)

Nexus Products by Part Number (8177777 - 9484123)

Part No.	Description
8177777	A12Q-SDUCR-3 (3/4"-S-BB-CT-RH)
8177788	A12Q-SDUCL-3 (3/4"-S-BB-CT-LH)
8178831	A16T-PDUNR-3 (1"-S-BB-CT-RH)
8178832	A20T-PDUNR-4 (1-1/4"-S-BB-CT-RH)
8178833	A24U-PDUNR-4 (1-1/2"-S-BB-CT-RH)
8178841	A16T-PDUNL-3 (1"-S-BB-CT-LH)
8178842	A20T-PDUNL-4 (1-1/4"-S-BB-CT-LH)
8178843	A24U-PDUNL-4 (1-1/2"-S-BB-CT-LH)
8188851	A16T-PVUNR-3 (1"-S-BB-CT-RH)
8188852	A20T-PVUNR-3 (1-1/4"-S-BB-CT-RH)
8188861	A16T-PVUNL-3 (1"-S-BB-CT-LH)
8188862	A20T-PVUNL-3 (1-1/4"-S-BB-CT-LH)
8188873	A24U-PWLNR-4 (1-1/2"-S-BB-CT-RH)
8188881	A16T-PWLNL-4 (1"-S-BB-CT-LH)
8188882	A20T-PWLNL-4 (1-1/4"-S-BB-CT-LH)
8188883	A24U-PWLNL-4 (1-1/2"-S-BB-CT-LH)
8607241	VNMG331NN-LT10-Insert
8607245	VNMG332NN-LT10-Insert
8607921	VNGG331-ALU-LT05-Insert
8607925	VNGG332-ALU-LT05-Insert
8608011	VNMG331NN-LT1000-Insert
8608016	VNMG332NN-LT1000-Insert
8608831	VCMT331NN-LT1000-Insert
8608836	VCMT332NN-LT1000-Insert
8649941	MWLNR-16-4D (1' square-TT-RH)
8649942	MWLNL-16-4D (1" square-TT-LH)
8655512	STGCR-08-2J (1/2"-TT-RH)
8655523	STGCL-08-2J (1/2"-TT-LH)
8655534	STGCR-12-3C (3/4"-CT-RH)
8655545	STGCL-12-3C (3/4"-TT-LH)

Part No.	Description
8665511	SCLCR-08-3J (1/2"-TT-RH)
8665522	SCLCL-08-3J (1/2"-TT-LH)
8665533	SCLCR-12-4C (3/4"-TT-RH)
8665544	SCLCL-12-4C (3/4"-TT-LH)
8669911	MCLNR-16-4D (1" square-TT-RH)
8669912	MCLNL-16-4D (1" square-TT-LH)
8675555	SDJCR-08-2J (1/2"-TT-RH)
8675566	SDJCL-08-2J (1/2"-TT-LH)
8675577	SDJCR-12-3C (3/4"-TT-RH)
8675588	SDJCL-12-3C (3/4"-TT-LH)
8679921	MDJNR-16-4D (1" square-TT-RH)
8679922	MDJNL-16-4D (1" square-TT-LH)
8689931	MVJNR-16-3D (1" square-TT-RH)
8689932	MVJNL-16-3D (1" square-TT-LH)
9202123	HF-2.00-.750C-4SN9 (2"-CT)
9212124	HF-2.50-.750C-4SN9 (2-1/2"-CT)
9223123	SHF-2.00-.750C-4SN9 (2"-CT)
9233124	SHF-2.50-.750C-4SN9 (2-1/2"-CT)
9353123	HF-3.00-1.00C-6SN9 (3"-CT)
9363123	SHF-3.00-1.00C-6SN9 (3"-CT)
9396762	PLSS1.00xM20 (1"-CT-ER40)
9396763	PLSS.750xM20 (3/4"-CT-ER40)
9396764	PLSS.500xM20 (1/2"-CT-ER40)
9396766	PLSS1.25xM24 (1-1/4"-CT-ER50)
9397764	PLSS.750xM16 (3/4"-CT-ER32)
9398765	PLSS.500xM16 (1/2"-CT-ER32)
9474123	HF-4.00-1.25C-7SN9 (4"-CT)
9484123	SHF-4.00-1.25C-7SN9 (4"-CT)

Nexus Products by Descriptions (4WD__ - CCM__)

Description	Part No.
4WD.625-.750C-2.50-3 (5/8"-D-RH)	1741234
4WD.750-.750C-3.00-3 (3/4"-D-RH)	1751244
4WD.875-1.00C-3.50-4 (7/8"-D-RH)	1751254
4WD1.00-1.00C-4.00-4 (1"-D-RH)	1761264
4WD1.25-1.25C-5.00-6 (1-1/4"-D-RH)	1771284
4WD1.375-1.25C-5.50-6 (1-3/8"-D-RH)	1771294
4WD1.50-1.25C-6.00-6 (1-1/2"-D-RH)	1781334
4WD1.75-1.50C-7.00-6 (1-3/4"-D-RH)	1781354
4WD2.00-1.50C-8.00-8 (2"-D-RH)	1781374
4WD2.25-1.50C-9.00-8 (2-1/4"-D-RH)	1751394
A06H-SCLCL-2 (3/8"-S-BB-CT-LH)	8167722
A06H-SCLCR-2 (3/8"-S-BB-CT-RH)	8167711
A06H-SDUCL-2 (3/8"-S-BB-CT-LH)	8177722
A06H-SDUCR-2 (3/8"-S-BB-CT-RH)	8177711
A08K-SCLCL-2 (1/2"-S-BB-CT-LH)	8167744
A08K-SCLCR-2 (1/2"-S-BB-CT-RH)	8167733
A08K-SDUCL-2 (1/2"-S-BB-CT-LH)	8177744
A08K-SDUCR-2 (1/2"-S-BB-CT-RH)	8177733
A08K-STFCR-2 (1/2"-S-BB-CT-RH)	8157711
A10M-SCLCL-3 (5/8"-S-BB-CT-LH)	8167766
A10M-SCLCR-3 (5/8"-S-BB-CT-RH)	8167755
A10M-SDUCL-2 (5/8"-S-BB-CT-LH)	8177766
A10M-SDUCR-2 (5/8"-S-BB-CT-RH)	8177755
A10M-STFCR-2 (5/8"-S-BB-CT-RH)	8157722
A12Q-SCLCL-3 (3/4"-S-BB-CT-LH)	8167788
A12Q-SCLCR-3 (3/4"-S-BB-CT-RH)	8167777
A12Q-SDUCL-3 (3/4"-S-BB-CT-LH)	8177788
A12Q-SDUCR-3 (3/4"-S-BB-CT-RH)	8177777
A12Q-STFCR-2 (3/4"-S-BB-CT-RH)	8157733
A16T-PCLNL-4 (1"-S-BB-CT-LH)	8168821
A16T-PCLNR-4 (1"-S-BB-CT-RH)	8168811
A16T-PDUNL-3 (1"-S-BB-CT-LH)	8178841
A16T-PDUNR-3 (1"-S-BB-CT-RH)	8178831
A16T-PVUNL-3 (1"-S-BB-CT-LH)	8188861
A16T-PVUNR-3 (1"-S-BB-CT-RH)	8188851
A16T-PWLNL-4 (1"-S-BB-CT-LH)	8188881
A16T-PWLN-4 (1"-S-BB-CT-RH)	8148871
A20T-PCLNL-4 (1-1/4"-S-BB-CT-LH)	8168822
A20T-PCLNR-4 (1-1/4"-S-BB-CT-RH)	8168812
A20T-PDUNL-4 (1-1/4"-S-BB-CT-LH)	8178842

Description	Part No.
A20T-PDUNR-4 (1-1/4"-S-BB-CT-RH)	8178832
A20T-PVUNL-3 (1-1/4"-S-BB-CT-LH)	8188862
A20T-PVUNR-3 (1-1/4"-S-BB-CT-RH)	8188852
A20T-PWLNL-4 (1-1/4"-S-BB-CT-LH)	8188882
A20T-PWLN-4 (1-1/4"-S-BB-CT-RH)	8148872
A24U-PCLNL-4 (1-1/2"-S-BB-CT-LH)	8168823
A24U-PCLNR-4 (1-1/2"-S-BB-CT-RH)	8168813
A24U-PDUNL-4 (1-1/2"-S-BB-CT-LH)	8178843
A24U-PDUNR-4 (1-1/2"-S-BB-CT-RH)	8178833
A24U-PWLNL-4 (1-1/2"-S-BB-CT-LH)	8188883
A24U-PWLN-4 (1-1/2"-S-BB-CT-RH)	8188873
ADKT1505PDTR-LT30-Insert	1506065
AOMT123608PETR-LT30-Insert	3153311
APEX100304PDFR-F01-Insert-5005-HP	3151236
APEX1604PDFR-F01-Insert-GH05-HP	3151239
APGT1003PDER-ALU-LT05-Insert	1506501
APGT1604PDER-ALU-LT05-Insert	1506505
APKT 100304 PDTR LT30-Insert	3154422
APKT 100312 PDTR LT30-Insert	3154433
APKT 100332 PDTR LT30-Insert	3154444
APKT 100340 PDTR LT30-Insert	3154455
APKT1604 PDTR-LT30-Insert	1506073
APKT160424ER-LT30-Insert	1500300
APKT1705PETR-LT30-Insert	1506077
APLX100308PDTR-LT 30-Insert	1506085
APLX100340PDTR-LT30-Insert	1501567
APLX1003PDTR-LT30-Insert	1506082
APMT1135PDTR-LT30-Insert	3153321
APMT160408PDTR-LT30-Insert	3153325
CCGX21.51-LH-Insert-101-HP	3663336
CCGX32.51-LH-Insert-101-HP	3663337
CCGX32.52-LH-Insert-101-HP	3663338
CCGX432-LH-Insert-101-HP	3663339
CCMT21.51NN-LT1000-Insert	3668011
CCMT21.51NN-LT10-Insert	3664411
CCMT32.51NN-LT1000-Insert	3668021
CCMT32.51NN-LT10-Insert	3664413
CCMT32.52NN-LT1000-Insert	3668026
CCMT32.52NN-LT10-Insert	3664416
CCMT32.52WM-LT 10-Insert	3664419

Nexus Products by Descriptions (CCM __ - MCL __)

Description	Part No.
CCMT431NN-LT10-Insert	3664421
CCMT432NN-LT10-Insert	3664425
CNGG431-ALU-LT05-Insert	6607901
CNGG432-ALU-LT05-Insert	6607905
CNMG431NN-LT1000-Insert	6608011
CNMG431NN-LT10-Insert	6607029
CNMG432NN-LT1000-Insert	6608016
CNMG432NN-LT10-Insert	6607033
CNMG432NR-LT10-Insert	6601436
CNMG432NX-LT1000-Insert	6608026
CNMG432WM-LT10-Insert	6600060
CNMG432WM-LT10-Insert	6607041
CNMG433NN-LT1000-Insert	6608021
CNMG433NN-LT10-Insert	6607037
CNMP432NN-LT1000-Insert	6608031
CNMP432NN-LT10-Insert	6607045
CNMP433NN-LT1000-Insert	6608036
CNMP433NN-LT10-Insert	3665525
DCGX21.51-LH-Insert-101-HP	3763336
DCGX32.52-LH-Insert-101-HP	3763337
DCMT21.51NN-LT1000-Insert	3768811
DCMT21.51NN-LT10-Insert	3764421
DCMT32.51NN-LT1000-Insert	3768821
DCMT32.51NN-LT10-Insert	3764424
DCMT32.52NN-LT1000-Insert	3768826
DCMT32.52NN-LT10-Insert	3764427
DCMT432PM4-Insert-5615	3732040
DNGG331-ALU-LT05-Insert	7607909
DNGG332-ALU-LT05-Insert	7607913
DNMG331NN-LT1000-Insert	7608011
DNMG331NN-LT10-Insert	7607061
DNMG332NN-LT1000-Insert	7608016
DNMG332NN-LT10-Insert	7607065
DNMG431NN-LT1000-Insert	7608021
DNMG431NN-LT10-Insert	7607069
DNMG432NN-LT1000-Insert	7608026
DNMG432NN-LT10-Insert	7607073
DNMG433NN-LT1000-Insert	7608031
DNMG433NN-LT10-Insert	7607077
EPGT 1.2(1).5L-W08-Insert-NS530	3934020

Description	Part No.
EPMT 1.5(3).5-PM5-Insert-5625	3934030
FM45-2.00C-.750-4-13 (2"-CT)	2521234
FM45-3.00C-1.25-6-13 (3"-CT)	2531235
FM45-4.00C-1.25-7-13 (4"-CT)	2541236
FM45-5.00C-1.50-8-13 (5"-CT)	2551237
FM90-2.00C-.750-4-16 (2"-CT)	2621234
FM90-3.00C-1.25-6-16 (3"-CT)	2631235
FM90-4.00C-1.25-7-16 (4"-CT)	2641236
FM90-5.00C-1.50-8-16 (5"-CT)	2651237
HF-2.00-.750C-4SN9 (2"-CT)	9202123
HF-2.50-.750C-4SN9 (2-1/2"-CT)	9212124
HF-3.00-1.00C-6SN9 (3"-CT)	9353123
HF-4.00-1.25C-7SN9 (4"-CT)	9474123
HFEM-0.75-0.75-WP05-02 (3/4"-CT)	1658810
HFEM-1.00-1.00-5.50-SD09-02 (1"-CT)	1668820
HFEM-1.00-1.00-7.00-SD09-02 (1"-CT)	1668822
HFEM-1.00-1.00CW-5.00-3SN9 (1"-CT-W)	6602118
HFEM-1.00-1.00CW-8.00-2SN9 (1"-CT-W)	6602117
HFEM-1.25-1.25-8.00-SD09-03 (1-1/4"-CT)	1678830
HFEM-1.25-1.25-8.00-SD12-02 (1-1/4"-CT)	1678840
HFEM-1.25-1.25CW-5.00-4SN9 (1-1/4"-CT-W)	6702119
HFEM-1.25-1.25CW-8.00-3SN9 (1-1/4"-CT-W)	6702120
HFEM-1.50-1.50-8.00-SD12-03 (1-1/2"-CT)	1688850
HFM-2.00-0.75-SD09-04 (2"-CT)	2928860
HFM-2.50-0.75-SD09-05 (2-1/2"-CT)	2928865
HFM-3.00-1.25-SD12-05 (3"-CT)	2938870
IEM90-.500-.500-4.00-1-10 (1/2")	1631234
IEM90-.500-.500C-4.00-1-10 (1/2"-CT-H13)	1632234
IEM90-.625-.625-5.00-2-10 (5/8")	1641235
IEM90-.625-.625C-5.00-2-10 (5/8"-CT-H13)	1642235
IEM90-.750-.750-5.00-2-10 (3/4")	1651236
IEM90-.750-.750C-5.00-2-10 (3/4"-CT-H13)	1652236
IEM90-1.00-1.00-6.00-3-10 (1")	1661237
IEM90-1.00-1.00C-6.00-3-10 (1"-CT-H13)	1662237
IEM90-1.25-1.25-6.00-3-16 (1-1/4")	1671238
IEM90-1.25-1.25C-6.00-3-16 (1-1/4"-CT-H13)	1672238
IEM90-1.50-1.25-6.00-4-16 (1-1/2")	1686239
IEM90-1.50-1.25C-6.00-4-16 (1-1/2"-CT-H13)	1682239
MCLNL-16-4D (1" square-TT-LH)	8669912

Nexus Products by Descriptions (MCL __ - TCM __)

Description	Part No.
MCLNR-16-4D (1" square-TT-RH)	8669911
MDJNL-16-4D (1" square-TT-LH)	8679922
MDJNR-16-4D (1" square-TT-RH)	8679921
MVJNL-16-3D (1" square-TT-LH)	8689932
MVJNR-16-3D (1" square-TT-RH)	8689931
MWLNL-16-4D (1" square-TT-LH)	8649942
MWLNLR-16-4D (1" square-TT-RH)	8649941
ODMT060508TN-LT30-Insert	3954411
ODMW060508TN-LT30-Insert	3954415
OFER070405TN-LT30-Insert	3954421
OFMT05T305TN-LT30-Insert	3954431
OFMT070405TN-LT30-Insert	3954435
PLHF-1.00-1.00C-5.00-3SN9 (1"-CT)	6612118
PLHF-1.00-1.00C-8.00-2SN9 (1"-CT)	6612117
PLHF-1.25-1.25C-5.00-4SN9 (1-1/4"-CT)	6712119
PLHF-1.25-1.25C-8.00-3SN9 (1-1/4"-CT)	6712120
PLIM.500-.500C-4.00-1-10 (1/2")	1632345
PLIM.500-.500C-4.00-1-10 (1/2"-CT-H13)	1633345
PLIM.750-.750C-5.00-2-10 (3/4")	1654345
PLIM.750-.750C-5.00-2-10 (3/4"-CT-H13))	1655345
PLIM1.00-1.00-6.00-3-10 (1")	1665345
PLIM1.00-1.00C-6.00-3-10 (1"-CT-H13))	1666345
PLSS.500xM16 (1/2"-CT-ER32)	9398765
PLSS.500xM20 (1/2"-CT-ER40)	9396764
PLSS.750xM16 (3/4"-CT-ER32)	9397764
PLSS.750xM20 (3/4"-CT-ER40)	9396763
PLSS1.00xM20 (1"-CT-ER40)	9396762
PLSS1.25xM24 (1-1/4"-CT-ER50)	9396766
PN11-3.00-1.00-08 (3"-FM)	2139910
PN11-4.00-1.25-10 (4"-FM)	2149920
PN11-5.00-1.50-12 (5"-FM)	2159930
PN11-6.00-1.50-14 (6"-FM)	2169940
PNEG110512R-CM-Insert-152	3959999
RCMT1204M0-LT10-Insert	3355525
RDMT0803M0-LT30-Insert	3355531
RDMT1204M0-LT30-Insert	3355541
SCLCL-08-3J (1/2"-TT-LH)	8665522
SCLCL-12-4C (3/4"-TT-LH)	8665544
SCLCR-08-3J (1/2"-TT-RH)	8665511
SCLCR-12-4C (3/4"-TT-RH)	8665533

Description	Part No.
SDJCL-08-2J (1/2"-TT-LH)	8675566
SDJCL-12-3C (3/4"-TT-LH)	8675588
SDJCR-08-2J (1/2"-TT-RH)	8675555
SDJCR-12-3C (3/4"-TT-RH)	8675577
SDKT1204AETN-LT30-Insert	3254411
SDMT09T312-DM-Insert-202-HF	3253310
SDMT120412-DM-Insert-202-HF	3253320
SEET13T3-LH-Insert-WSK10-HP	3251239
SEGT1204AFEN-ALU-LT05-Insert	2506509
SEKN1203AFTN-LT30-Insert	3254415
SEKR1203AFTN-LT30-Insert	3254431
SEKT1204AFTN-LT30-Insert	3254435
SEKT12T3AGTN-LT30-Insert	2506169
SFM45-2.00C-.750-4-13 (2"-CT)	2421234
SFM45-3.00C-1.25-6-13 (3"-CT)	2431235
SFM45-4.00C-1.25-7-13 (4"-CT)	2441236
SFM45-5.00C-1.50-8-13 (5"-CT)	2451237
SFM90-2.00C-.750-4-16 (2"-CT)	2321234
SFM90-3.00C-1.25-6-16 (3"-CT)	2331235
SFM90-4.00C-1.25-7-16 (4"-CT)	2341236
SFM90-5.00C-1.50-8-16 5"-CT)	2351237
SHF-2.00-.750C-4SN9 (2"-CT)	9223123
SHF-2.50-.750C-4SN9 (2-1/2"-CT)	9233124
SHF-3.00-1.00C-6SN9 (3"-CT)	9363123
SHF-4.00-1.25C-7SN9 (4"-CT)	9484123
SNKX09T3HF-LT30-Insert	2502115
SNMG432NN-LT10-Insert	3263311
SNMG433NN-LT10-Insert	3263322
STGCL-08-2J (1/2"-TT-LH)	8655523
STGCL-12-3C (3/4"-TT-LH)	8655545
STGCR-08-2J (1/2"-TT-RH)	8655512
STGCR-12-3C (3/4"-CT-RH)	8655534
TCGX21.51-LH-Insert-101-HP	3563336
TCGX32.52-LH-Insert-101-HP	3563337
TCMT1.2(1).5PF4-Insert-5615	3533010
TCMT1.2(1)1PF4-Insert-5625	3533020
TCMT1.8(1.5)1PF4-Insert-5625	3533030
TCMT21.51NN-LT1000-Insert	3568831
TCMT21.51NN-LT10-Insert	3564431
TCMT21.52NN-LT1000-Insert	3568841

Nexus Products by Descriptions (TCM __ - WPG)

Description	Part No.
TCMT21.52NN-LT10-Insert	3564435
TCMT32.51NN-LT1000-Insert	3568851
TCMT32.51NN-LT10-Insert	3564438
TCMT32.52NN-LT1000-Insert	3568861
TCMT32.52NN-LT10-Insert	3564441
TNGG331-ALU-LT05-Insert	3567711
TNMG331NN-LT1000-Insert	3578011
TNMG331NN-LT10-Insert	3577715
TNMG332NN-LT1000-Insert	3578016
TNMG332NN-LT10-Insert	3567721
TNMG333NN-LT1000-Insert	3578021
TNMP332NN-LT1000-Insert	3578026
TNMP332NN-LT10-Insert	3567735
TPKN32PDTR-LT30-Insert	3567741
TPKN43PDTR-LT30-Insert	3567745
TPKR323PDTR-LT30-Insert	3567751
TPKR43PDTR-LT30-Insert	3567755
TPUN322-LT30-Insert	3567761
VBMT22 NN-LT10-Insert	3862215
VBMT331NN-LT10-Insert	3862221
VBMT332NN-LT10-Insert	3862225
VCMT331NN-LT1000-Insert	8608831
VCMT332NN-LT1000-Insert	8608836
VNGG331-ALU-LT05-Insert	8607921

Description	Part No.
VNGG332-ALU-LT05-Insert	8607925
VNMG331NN-LT1000-Insert	8608011
VNMG331NN-LT10-Insert	8607241
VNMG332NN-LT1000-Insert	8608016
VNMG332NN-LT10-Insert	8607245
WCMX030208R53-201-Drill Insert	341111
WCMX040208NN-LT30-Drill Insert	3441121
WCMX050308NN-LT30-Drill Insert	3441125
WCMX06T308NN-LT30-Drill Insert	3441131
WCMX080412NN-LT30-Drill Insert	3441135
WNMG331NN-LT10-Insert	3463311
WNMG332NN-LT10-Insert	3463315
WNMG431NN-LT1000-Insert	4608011
WNMG431NN-LT10-Insert	4607257
WNMG432NN-LT1000-Insert	4608016
WNMG432NN-LT10-Insert	4607261
WNMG432NR-LT10-Insert	4601437
WNMG432NX-LT1000-Insert	4608021
WNMG432WM-LT10-Insert	4600076
WNMG433NN-LT1000-Insert	4608026
WNMG433NN-LT10-Insert	4607265
WNMP432NN-LT1000-Insert	4608031
WNMP432NN-LT10-Insert	4607277
WPGT050315ZSR-Insert-351-HF	3451112

Master Hardware List

Torx Screws

Part No.	Description
6811270	HM6.3-1.0-13.2
9311455	I60M2.5-5.5
9316547	I60M2.5-6.5
9317446	I60M3.5-8.0
9318446	I60M3.5-12
9319345	I60M4-10
9319446	I60M4-11
9318547	I60M4-8.4
9312345	M1.8-4.2-2.5-54
9313345	M2-5.0-2.7-60
9314345	M2.5-5.0-3.7-43
9315345	M2.5-6.0-3.5-60
9315446	M2.5-6.3-3.35-60
9316446	M2.5-6.45-3.7-60
9317345	M3.0-8.0-4.0-43
9318345	M3.5-12.0-5.3-60
9317547	M3.5-8.0-5.3-60
9311311	M4-10-5.0-43
9319345	M4.0-10.0-5.7-60
6811210	TM2.0-4.0
6811215	TM2.0-4.9
6811220	TM2.2-5.6
6811230	TM2.2-6.4
6811235	TM2.5-4.8
6811240	TM2.5-5.8
6811250	TM2.5-6.0
6811255	TM2.5-6.8
6811256	TM3.5-5.0
6811259	TM3.5-8.0
6811262	TM4.0-15.0
6811257	TM4.0-5.5
6811260	TM4.0-8.5
6811266	TM5.0-13.1

Hex Screws

Part No.	Description
9319547	SM5-8.65XA
9319648	SM6-10XA

Torx Wrenches

Part No.	Description
9355111	T6Flag
9355222	T7Flag
9355333	T8Flag
9355321	T9Flag
9355444	T10Flag
9355555	T15Flag
9355666	T20Flag

Hex Wrenches

Part No.	Description
9322111	WH20L
9322116	WH25L
9322121	WH30L
9322126	WH35L

Shims

Part No.	Description
9333252	C12APB
9333111	C12BM
9333222	C12BS
9333333	D11BS
9333353	D15AP
9333444	D15BM
9333555	T16BS
9333666	V16BM
9333777	V16BS
9333757	W08AP
9333888	W08BM

Shim Pin

Part No.	Description
9333999	SP4

Clamps

Part No.	Description
9344111	C1RD
9344222	C2RD
9344333	C3RD

Clamp Screw

Part No.	Description
9344888	DM6-30

Wedges

Part No.	Description
9344454	WD-204
9344444	WD-208

Levers

Part No.	Description
9335111	L3D
9335222	L4
9335333	L4A

Lock Pins

Part No.	Description
9344555	TM5-13
9344666	TM6-17
9344777	TM6-19

Lock Screws

Part No.	Description
9345111	LEM5-12B
9345222	LEM6-13A
9345333	LEM8-21

Boring Screws/Washers

Part No.	Description	Cartridge
6811280	D-68-29	Adjusting
6811290	D-85-29	Adjusting
6811310	D-68-26	Mounting
6811320	D-85-27	Mounting
6811410	D-68-28	Washer

Coupling Screws

Part No.	Description
6811510	TC-22-68
6811520	TC-27-610
6811530	TC-32-810
6811540	TC-42-1014
6811550	TC-54-1220
6811560	TC-68-1624
6811570	TC-85-1630
6811580	TC-100-2035
6811590	TC-M12X40



Earth Chain Magnetic Products



- 26 sizes
- Turnkey workholding

EEMP Magnetic Workholding Chucks

- Fast and flexible magnetic workholding solution
- Machine 5 sides and through hole drilling



EARTH-CHAIN
Power that works.



- 4 sizes available

ECB Magnetic Vises

- Slash setup and part change over times
- Modular vises adapt to your workpiece

EZ-Lift Magnets

- Lift up to 6,600 lbs
- 3.5X Safety Factor

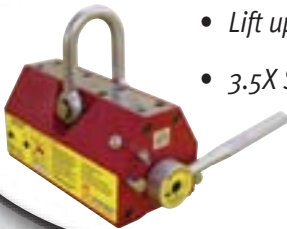

Earth Chain Magnetic Products



MagVISE EEPM Electro-Permanent Chucks



The right solutions for your application.

Features:

- 5-sided machining and through-hole drilling
- Will not lose holding power during power outage
- Spring-loaded induction blocks hold warped stock

Benefits:

- Cut set-up & part change-over time 50% or more!
- Improved machining for better finish and tool life
- Uniform holding = No workpiece deformation

We Are A Turn-Key Magnetic Workholding Solutions Provider

Contact us for solutions to your workholding bottlenecks.

Earth Chain Magnetic Products





See a video of the EEPM chucks in action on our website: www.earthchain.com

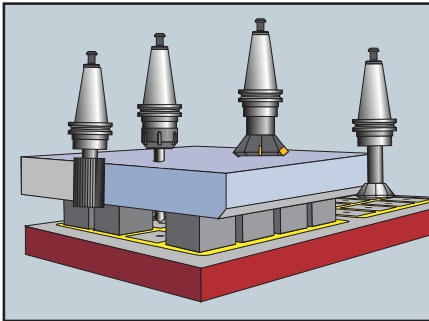

Machine 5 sides freely and thru-hole drill



Milling warped stock with induction blocks

Use magnetic workholding for drilling, milling, and boring operations on thick or thin* workpieces. Magnetic power makes difficult workholding jobs faster and safer.

** Holding power varies with type of material and thickness.*



Flood coolant hole-making application

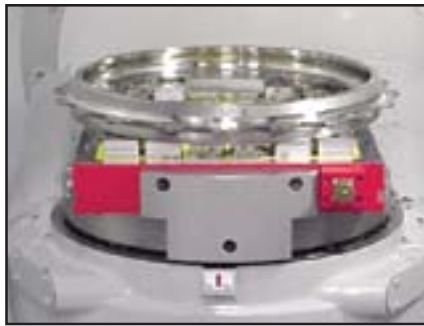

5 axis machining



Rotary Table application

Our magnetic chucks easily integrate with pallet changing and tombstone systems used in production cells. Since no electricity is needed to keep the chuck ON, the electro-permanent magnet keeps on holding tight even during a complete power loss.



Heavy side loads



Fast setups and part changeover



Use induction blocks as work stops



Holding power to take big cuts

Choose magnetic workholding for uniform holding of the workpiece, without part distortion or dead spots. Uniform workholding reduces chatter and harmonics for improved surface finish and tool life.



MagVISE EEPM Electro-Permanent Chucks

Ordering Electro-Permanent Chucks

- Workpiece should be at least 0.4" thick
- Workpiece should cover at least 4 poles for maximum holding power
- Requires dedicated, 480v, single phase, 30A power supply



Chucks can be built to fit your application requirements.

Machinable Subplates

- Mounts on top of magnetic chuck
- Fast, repeatable part positioning
- Protects chuck surface



Control is included with chuck and includes remote. Order subplates and induction blocks separately.

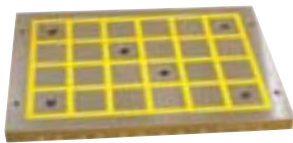

Subplates are sized to match your chuck. They are 1" thick. See table below.

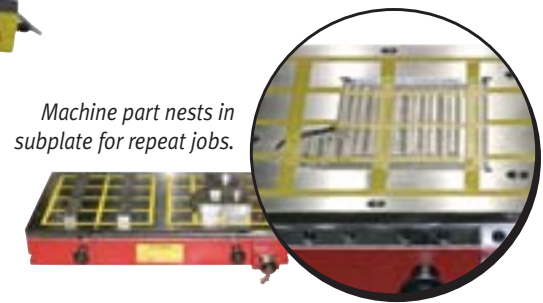

Machine part nests in subplate for repeat jobs.

$$S = 1.2" - S1 = 1" - G = 0.4" - M = 1.2"$$

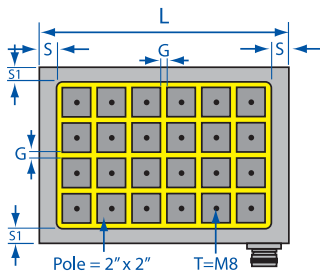

Fig. 1

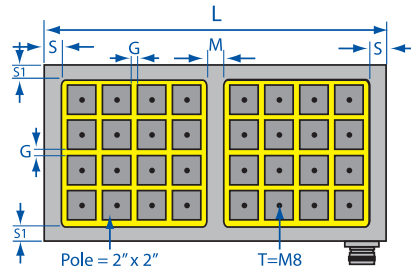

Fig. 2

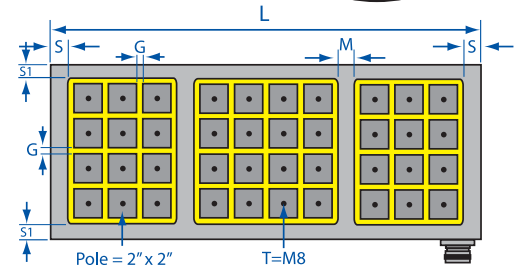

Fig. 3

Part No.	Fig	L x W x H	Poles	Amps	Chuck Wt.	Subplates*	Controller
EEPM-2540W-480	1	16.9" x 9.4" x 2.8"	18	30	110 lbs.	EEPM-2540ISP	EEPM-C1
EEPM-2580W-480	3	31.9" x 9.4" x 2.8"	33	30	202 lbs.	EEPM-2580ISP	EEPM-C1
EEPM-3030W-480	1	12.2" x 11.8" x 2.8"	16	30	97 lbs.	EEPM-3030ISP	EEPM-C1
EEPM-3060W-480	2	23.2" x 11.8" x 2.8"	32	30	180 lbs.	EEPM-3060ISP	EEPM-C1
EEPM-4040W-480	1	16.9" x 16.5" x 2.8"	36	30	185 lbs.	EEPM-4040ISP	EEPM-C2
EEPM-4080W-480	3	31.9" x 16.5" x 2.8"	66	30	350 lbs.	EEPM-4080ISP	EEPM-C2
EEPM-4090W-480	3	34.3" x 16.5" x 2.8"	72	30	372 lbs.	EEPM-4090ISP	EEPM-C4
EEPM-5060W-480	2	23.2" x 18.9" x 2.8"	56	30	284 lbs.	EEPM-5060ISP	EEPM-C2
EEPM-50100W -480	3	39.0" x 18.9" x 2.8"	98	30	482 lbs.	EEPM-50100ISP	EEPM-C4
EEPM-6060W-480	2	23.2" x 23.6" x 2.8"	72	30	363 lbs.	EEPM-6060ISP	EEPM-C4
EEPM-6080W-480	3	31.9" x 23.6" x 2.8"	99	30	473 lbs.	EEPM-6080ISP	EEPM-C4
EEPM-60100W-480	3	39.0" x 23.6" x 2.8"	126	30	603 lbs.	EEPM-60100ISP	EEPM-C4
EEPM-8080W-480	3	31.9" x 29.7" x 2.8"	121	30	596 lbs.	EEPM-8080ISP	EEPM-C4

*Subplates are the same dimensions as the chucks, except they are 1" thick (H).



Magnetic Induction Blocks

- 5-sided machining and thru-hole drilling
- Protect and prolong life of chuck
- Hold warped or irregularly shaped stock

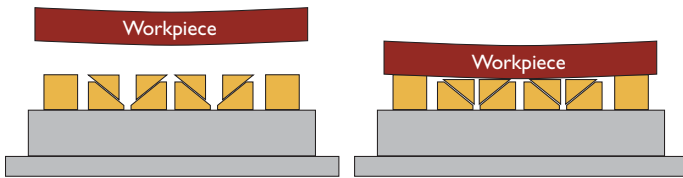

EEPM-SP50
spring-loaded for holding
warped stock

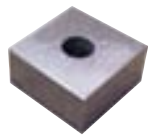

EEPM-S50
solid



EEPM-SPF50
tapped hole



Machine induction blocks
to create work-stops for
fast, accurate part align-
ment when ganging parts
together for repeat jobs.



EEPM-SPF50-STOP
workstop

Item #	Description	L x W x H
EEPM-S50	Fixed, soft induction block (8mm screw included)	1.97" x 1.97" x 0.98"
EEPM-SP50	Spring adjusting induction block (2 piece set, 8mm screw)	1.92" x 1.81" x 1.81"
EEPM-SPF50	Fixed, soft induction block, use at corners with EEPM-SP50 spring blocks. (8mm screw)	1.97" x 1.97" x 1.65"
EEPM-SPF50-STOP	Fixed, soft induction block with work-stop (rotating) for fast, accurate positioning	1.97" x 1.97" x 1.65"

Custom Tombstones



Built to your specifications:

- Gang part setups together
- Fastest setups for pallet systems
- Ideal for work cube process



Call us to discuss your needs:
(800) 597-3921 or local (317) 803-8000



All Techniks products are backed by our 100% satisfaction guarantee!



MagVISE ECB Permanent Magnetic Vises



Features:

- No electricity required
- Modular layout for custom setups
- Spring-loaded induction blocks hold warped stock

Benefits:

- Slash setup and part change over times
- 5-sided machining
- No workpiece deformation
- Improve machining performance

4 sizes available

See a short video of the MagVISE Magnetic Vises action on our website: www.earthchain.com

Earth Chain Magnetic Products

We Are A Turn-Key Magnetic Workholding Solutions Provider

Contact us for solutions to your workholding bottlenecks.



Gang setups together



Modular for large work



Fast, flexible workholding



Great for large, irregular workpieces

MagVISE ECB Application Examples



Use lifters to move stock, MagVISE to hold



Setup for a long and narrow part



Indexing table application

ECB MagVISE Permanent Magnetic Vises

4 sizes available



Includes 2 machinable induction blocks, wrench, extension and socket, switch-connect socket assembly, 2 stop plates, 4 toe clamps.

MagVISE Permanent Magnetic Vises slash setup times on horizontal or vertical CNC machine tools. They are used for all types of machining and boring operations on thin to thick workpieces.

No electricity is needed. Turn the magnetic vise "ON" and "OFF" with the turn of a wrench. Our magnetic vises easily integrate with pallet changing and tombstone systems for horizontal and vertical machining centers.

See a short video of the MagVISE Magnetic Vises action on our website: www.earthchain.com

Modular ECB magnetic vises hold irregular stock sizes, warped stock, and large workpieces, without the need for special fixturing.



MagVISE ECB Vise Dimensions

Part No.	L x W x H	A	B	Min. Stock Thickness	Holding Power	Weight
ECB-050	5" x 3" x 3"	.47"	.47"	0.4"	1,100 lbs.	15 lbs.
ECB-075	6.8" x 3" x 3"	.47"	.47"	0.4"	1,650 lbs.	19 lbs.
ECB-120	7.3" x 4.2" x 4.2"	.62"	.59"	0.6"	2,640 lbs.	40 lbs.
ECB-210	9.2" x 5.2" x 5.3"	.65"	.84"	0.8"	4,620 lbs.	80 lbs.

Accessories (for ECB 120 & ECB 210 only)

ECB-SPF50	1, soft fixed induction block, 10mm screw - use with ECB-SP50 spring blocks. Dimensions: 1.97" x 1.97" x 1.65"
ECB-SP50	2, spring loaded induction block, 10mm screw - use with ECB-SPF50 on corners. Dimensions: 1.89" x 1.81" x 1.89"

Note: Holding power depends on workpiece size, material, surface finish, contact area with magnet, and workpiece thickness.



All Techniks products are backed by our 100% satisfaction guarantee!



EZ-Lift ELM Material Handling Magnets

Smallest, Most Powerful Lifter – With The Industry’s Best Safety Factor (3.5 X Rating)

Features

- No electricity required
- Fastest & Safest way to lift
- Lift flat or round stock
- Capacity up to 6,600 lbs., higher with spreader bars

Benefits

- Safer than straps and slings
- So simple anyone can use it
- Reduces transport and setup time for more productivity

Our customers prefer ELM lift-ing magnets because they are the smallest, most powerful lift-ing magnets available with a **3.5X SAFETY FACTOR**. Our safety factor is the best in the industry.

ELM lifters feature super-powerful rare-earth neodymium iron boron lift-ing magnets that require no electric-ity and have dozens of uses. Load and unload plate, block, or round steel and iron stock. Use them on press molds, machined parts, and other ferrous materials. Use spreader bars to lift large material.



ELM-100 (above)
lifts 220 lbs.



ELM-600 (left)
lifts 1,320 lbs.

Videos & case-studies at:
www.earthchain.com



Spreader Bars capacity
up to 13,500 lbs.

Earth Chain Magnetic Products

The Old Way: Material Handling

A) Risk of Injury

Risk of injury to back, fingers, or toes when moving material in order to position sling or chain.

B) Slings & Chains Wear Out

Lifting equipment needs to be recertified and replaced periodically.

C) Lost Productivity

It takes time to properly setup slings or chains to safely move materials.



The Earth-Chain Way: ELM Lifting Magnets

A) Beat Safety Factor – 3.5X Rated Capacity

Simply center lifting magnet on most workpieces to lift.

B) EZ-Lift Lasts Forever

Rare-Earth magnet will never wear out and uses no electricity.

C) Increase Productivity

EZ-Lift is the fastest and safest way to transport raw stock and workpieces.



EZ-Lift Application Examples



Safest way to move ferrous stock.



Use to setup CNC machining centers.

**3.5 X
Safety
Factor**



Best Safety Factor Available
All our lifting magnets have a safety factor of 3.5 times the rated capacity.



Center magnet on most workpieces to lift.



Beveled bottom surface lifts round stock.

EZ-Lift Operation

Calculate Maximum Load for your stock. Center the magnet on the workpiece. Move lever to the "ON" position to lift. Follow all directions in the Operating Instructions that comes with your magnet.



Lever in the "ON" position. The safety lock is engaged.



Lever in the "OFF" position.



Use spreader bars for large or unbalanced loads.



Vertical Lifters can be operated by one person.

How It Works:

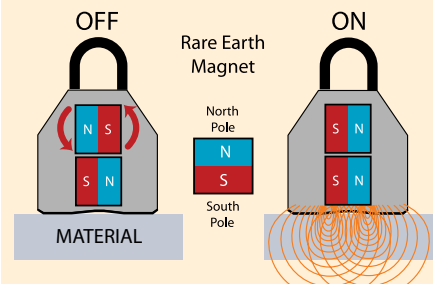

Each ELM lifting magnet contains super powerful rare earth magnets arranged in 3 rows. The OFF position is when the magnetic poles are in alignment as shown (top left).

Turning the lever to the ON position rotates the center row of magnets 180° so the poles alternate, creating a powerful magnetic field.

Never attempt to turn the magnet ON unless it is placed on a correctly sized piece of material to be moved, or you may cause injury to yourself, or the ELM lifting magnet. Always follow all instructions carefully.



Eliminate straps, slings and associated dangers.



Locate magnet at balance point for lifting.

Earth Chain Magnetic Products



EZ-Lift Magnets / Calculating Maximum Loads

EZ-Lift Ordering Information and Rated Capacities – Plate & Round Steel

Part No.	Plate	Round	A	B	C	D	E	F	G	H	Weight
ELM-100	220 lbs.	99 lbs.	4.2"	3.3"	4.7"	4.9"	2.4"	2.8"	1.6"	1.2"	5.5 lbs.
ELM-300	660 lbs.	300 lbs.	7.1"	6.1"	6.1"	7.3"	3.6"	3.7"	2.0"	1.6"	18.9 lbs.
ELM-600	1,320 lbs.	600 lbs.	10.0"	8.8"	8.3"	10.2"	4.5"	4.7"	3.0"	2.0"	46 lbs.
ELM-1000	2,200 lbs.	990 lbs.	11.0"	9.6"	11.3"	14.6"	6.5"	6.7"	3.8"	3.4"	101 lbs.
ELM-2000	4,400 lbs.	1,980 lbs.	16.6"	15.0"	13.7"	20.2"	8.5"	8.5"	4.1"	4.8"	259 lbs.
ELM-3000	6,600 lbs.	2,970 lbs.	22.3"	20.9"	15.7"	30.3"	8.5"	8.7"	5.8"	3.2"	399 lbs.



Formula for Calculating Maximum Load by Material Type

$$T \text{ (thickness)} \times F \text{ (finish)} \times M \text{ (material)} \times \text{Capacity} = \text{ML}$$

Example: (ELM-600/plate steel) 2" (T=100%) x F2(100%) x M2 (85%) x 1,320 lbs. = **1,122 lbs.**

M Lifting Power by Material

Carbon Content	Carbon Content		
	0%	50%	100%
M1	Low Carbon		100%
M2	Moderate Carbon		85%
M3	High Carbon		75%
M4	Cast Iron		70%

F Effect of Surface Finish

Surface Finish	Surface Finish			
	0%	50%	100%	150%
F1	Ground Surface			125%
F2	Rough Machined		100%	
F3	Foundry Finish		90%	
F4	~ Rough Cast		65%	

Calculating Maximum Loads

Calculate that the magnet will safely lift your material. Maximum Load (ML) is different for plate and round materials, and also depends upon stock thickness, carbon content, and surface finish. Use the formula and tables to calculate ML for your material type.

Rated Capacity

Part No.	Plate Steel*
ELM-100	220 lbs.
ELM-300	660 lbs.
ELM-600	1,320 lbs.
ELM-1000	2,200 lbs.
ELM-2000	4,400 lbs.
ELM-3000	6,600 lbs.

Part No.	Round Steel*
ELM-100	99 lbs.
ELM-300	300 lbs.
ELM-600	600 lbs.
ELM-1000	990 lbs.
ELM-2000	1,980 lbs.
ELM-3000	2,970 lbs.

T Equals Percent of Lifting Power by T (thickness)

T	ELM-100	ELM-300	ELM-600	ELM-1000	ELM-2000	ELM-3000
2 3/8" (60mm)	100%	100%	100%	100%	100%	100%
2 1/8" (55mm)	100%	100%	100%	100%	100%	95%
2.0" (50mm)	100%	100%	100%	100%	95%	90%
1 3/4" (45mm)	100%	100%	100%	100%	90%	85%
1 1/2" (40mm)	100%	100%	100%	100%	85%	80%
1 3/8" (35mm)	100%	100%	100%	90%	75%	70%
1 1/8" (30mm)	100%	100%	100%	80%	65%	60%
1.0" (25mm)	100%	100%	90%	70%	55%	50%
3/4" (20mm)	100%	90%	75%	60%	45%	40%
1/2" (15mm)	100%	70%	60%	50%	35%	30%
3/8" (10mm)	70%	50%	45%	35%	25%	20%
1/4" (5mm)	40%	30%	25%	20%	15%	10%

*Follow all directions in the Operating Instructions that comes with your magnet.



EZ-Lift Spreader Bars

- For better overall balance
 - Use with multiple magnetic lifters
 - Lifter span adjustable
- Keeps large materials balanced for safer transport.

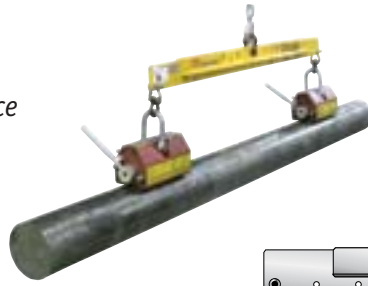

Control large or irregular loads during transport. Increase lifting power by adding more magnets. Includes bar, 1 upper and 2 lower S.P.A. shackles. Order magnets separately.

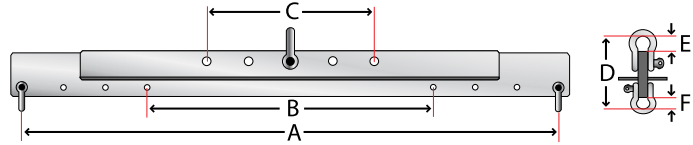

Part No.	Capacity	A	B	C	D	E	F	Weight
ELM-SB250	250 lbs.	36"	18"	12"	5.1"	1.25"	.85"	20 lbs.
ELM-SB500	500 lbs.	46"	22"	16"	5.7"	1.35"	1.34"	25 lbs.
ELM-SB1000	1,000 lbs.	72"	36"	24"	6.9"	1.35"	1.34"	65 lbs.
ELM-SB2000	2,000 lbs.	72"	36"	24"	7.3"	2.02"	1.35"	115 lbs.
ELM-SB4000	4,000 lbs.	77"	41"	24"	10.5"	2.43"	1.63"	195 lbs.
ELM-SB8000	8,000 lbs.	96"	48"	24"	12.3"	2.94"	1.78"	300 lbs.
ELM-SB10000	10,000 lbs.	116"	56"	24"	14.7"	3.5"	1.65"	600 lbs.
ELM-SB13500	13,500 lbs.	140"	68"	36"	17.1"	4.0"	2.02"	880 lbs.

EZ-Lift Vertical Lifters

- Fast loading for vertical transport
- One person can load and unload
- No dangerous straps & slings



Used for vertical transport of plate stock. Includes ELM lifting magnet.

Part No.	Size L x W x H	Capacity	Weight	Plate Size L x W x H (min/max)		
				L	W	H
ELM-300V	37.5" x 8.5" x 10"	660 lbs.	57 lbs.	8"/60"	11.8"/31.5"	0.25"/5.9"
ELM-600V	46" x 11" x 10"	1,320 lbs.	86 lbs.	12"/72"	11.8"/39.4"	0.31"/9.8"
ELM-1000V	48" x 14" x 12"	2,200 lbs.	128 lbs.	12.5"/79"	11.8"/39.4"	0.39"/11.8"



Position lifter on stock and turn the lever to the on position. Hoist into vertical position for transport. Always follow operating instructions included.



sPINner Magnetic Deburring Machine

Tough & reliable, the sPINner is KING of small precision parts deburring!

Applications

- medical parts - swiss turned
- drilled or threaded parts
- machined or stamped parts

Benefits

- costs less than hand deburring
- deburr parts faster & better
- improve quality of parts
- see case studies at earthchain.com

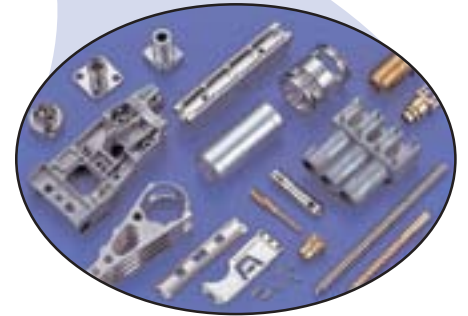

See actual sPINner case-studies at: www.earthchain.com

The Old Way: Deburring Parts

- A) Time Consuming**
Hand deburring is labor intensive and time consuming process
- B) Production Bottleneck**
Deburring often limits how productive you can be
- C) Expensive**
Deburring requires expensive manual labor driving costs up



The Earth-Chain Way: sPINner Deburring

- A) Deburr Faster & Better**
Improve part quality and get more consistent results
- B) Speeds Production**
Batch deburr dozens, hundreds, or thousands of parts in minutes
- C) Reduce Costs**
Eliminate expensive hand deburring and increase production





Send us your parts for a free deburring analysis!

The sPINner works best on small, precision parts, made from non-ferrous metals including: aluminum, brass, copper, stainless steel, and titanium. The deburring process will not affect tolerances or damage delicate parts.

Send your parts to:

Earth-Chain sPINner Deburring
9930 East 56th St.,
Indianapolis, IN 46236



Contact Us For Deburring Service

Not ready for a sPINner?
We offer deburring services. Call (800) 597-3921 and ask to speak to a representative.



The sPINner is used in many industries including medical, aerospace, and electronics. It is also a good fit for most parts made on CNC Swiss-type lathes.

Typical Deburred Parts



Aluminum Gear Application

Burrs and rough edges. Deburred part in only 10 minutes.
Part Dimensions: 1 9/16" diameter x 5/16" high.

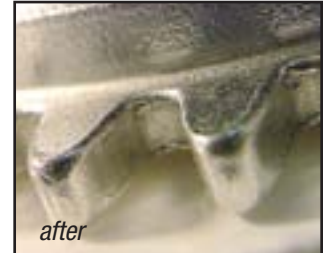

Complex Turned & Machined Aluminum

Burrs on O.D. and in I.D. slots. Batch deburring in only 10 minutes! Part Dim.: 3/16" diameter x 1 3/16" long.



The sPINner deburrs these part features

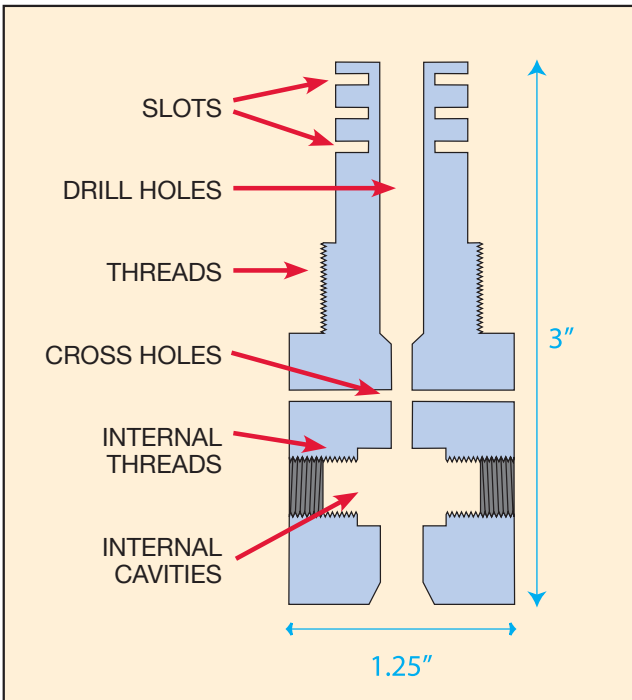

0.01" Diameter Slot in Light Alloy Collar

Fine burrs in hard-to-reach slotted area. Eliminated part quality problem and saved labor costs. Part Dimensions: 1 7/32" diameter x 1/8" high.





sPINner Machines, Media, Deburring Solution

EHD sPINner Machines

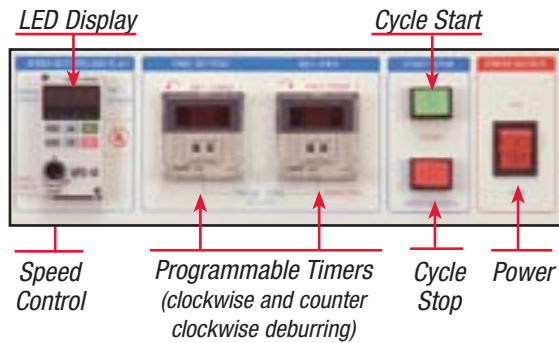

You can increase or decrease the power using the programmable control, or by selecting larger or smaller media. Parts are demagnetized at the end of the deburring cycle.

Part No.	Dim. L x W x H	Tank Size L x W	Power	Amps	Weight
EHD-728	19" x 19" x 37"	11" x 11"	220V	5	160 lbs.
EHD-735	23" x 26" x 34"	15" x 16"	220V	10	220 lbs.
EHD-750	29" x 30" x 36"	21" x 23"	220V	15	385 lbs.

All power requirements are single phase.
Includes: 2 deburring containers, 1 separating container, and 1 manual.
Media and deburring solution sold separately.

Stainless Steel Pin Media (SUS 304 with magnetic treatment)

This special stainless steel media is hardened to HRC 30, and will last for years in most applications. To deburr hard materials like stainless steel, steel, etc., use a diameter of media bigger than 0.5mm. Use sizes less than 0.5mm for soft material like brass, copper, aluminum, gold, etc. Choose larger pins for harder material and/or to increase deburring power.

If you want to deburr small holes, choose a diameter of pin media that is smaller than the hole. 3mm length media will work better for small holes and crevices.

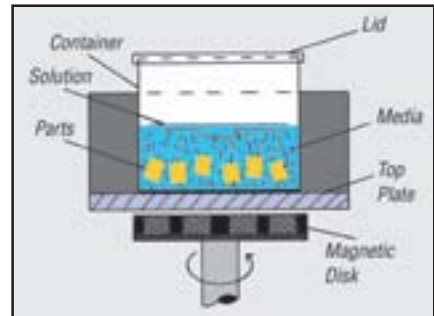

The only moving part is the magnetic disk!



Standard Dimension Media (diameter x length in millimeters)

Part No.	EHD-S1	EHD-S2	EHD-S3	EHD-S4	EHD-S5	EHD-S6	EHD-S7	EHD-S8	EHD-S9
Size (mm)	0.2x5mm	0.3x5mm	0.4x5mm	0.5x5mm	0.7x5mm	0.8x5mm	1.0x5mm	1.2x5mm	1.5x5mm

Special Dimension Media (diameter x length in millimeters)

Part No.	EHD-P1	EHD-P2	EHD-P3	EHD-P4	EHD-P5	EHD-P6	EHD-P7	EHD-P8
Size (mm)	0.3x3mm	0.4x3mm	0.5x1mm	0.5x3mm	0.7x3mm	0.8x3mm	1.0x1mm	1.0x3mm



PFS-747 Deburring Solution

Used with all types of materials. Dilute to a 50:1 ratio with water. Other solutions may be used, call for recommendations.

Part No.	Description
PFS-747	1/2 gallon deburring solution
PFS-7475G	5 gallons deburring solution

Part No.	Page	Part No.	Page	Part No.	Page	Part No.	Page	Part No.	Page
APGT1003PDERALULT05 .240		CAT50SLN1/2129		EEPM-5060W-480274		ELM-300V281		SEKT 12T3 PLSN.227	
APGT1604PDERALULT05 .242		CAT50SLN1/4129		EEPM-60100ISP274		ELM-600280		SNKX 09T3-HF.243	
APKT 1604 PDTR.241		CAT50SLN11/4.129		EEPM-60100W-480274		ELM-600V281		SYOZ20-TWA.205	
APLX LT 30.239		CAT50SLN3/4129		EEPM-6060ISP274		ELM-SB1000.281		TE-22HN21	
BD-TH-1031208		CAT50SLN3/8129		EEPM-6060W-480274		ELM-SB10000281		WPGT0503237	
BD-TH-1062208		CAT50SLN5/8129		EEPM-6080ISP274		ELM-SB13500281		00100-HS1.111	
BD-TH-1063208		DNA11TWA.52		EEPM-6080W-480274		ELM-SB2000.281		00100-HS2.111	
CAT40ER11-3128		DNA11TWA.205		EEPM-8080ISP274		ELM-SB250281		00100-HS3.111	
CAT40ER11-4128		DNA11W204		EEPM-8080W-480274		ELM-SB4000.281		00100-HS4.111	
CAT40ER11-6128		DNA16TWA.53		EEPM-C1.274		ELM-SB500281		00100-HS5.111	
CAT40ER16-2.76.128		DNA16TWA.205		EEPM-C2.274		ELM-SB8000.281		00100-HS6.111	
CAT40ER16-4128		DNA16W53		EEPM-C4.274		HSA-4-633		00151110	
CAT40ER20-2.76.128		DNA16W204		EEPM-S50275		HSA-4-677		00152110	
CAT40ER20-4128		DNA20TWA.53		EEPM-SP50275		HSA-4-678		00153110	
CAT40ER20-6128		DNA20TWA.205		EEPM-SPF50.275		HSA-4-688		00156111	
CAT40ER25-2.76.128		DNA20W53		EEPM-SPF50-STOP275		HSA-6-625		00157110	
CAT40ER25-4128		DNA20W204		EHD-728284		HSA-6-628		00158110	
CAT40ER32-2.76.128		DNA32TWA.53		EHD-735284		HSA-6-683		00159110	
CAT40ER32-4128		DNA32TWA.205		EHD-750284		NT-5430013039		00160111	
CAT40ER40-3.15.128		DNA32W53		EHD-P1284		NTS-40-TAPER.206		00165110	
CAT40SLN1129		DNA32W204		EHD-P2284		NTS-BT30-38206		00166110	
CAT40SLN1 1/4-2129		ECB-050277		EHD-P3284		NTS-BT30-41206		00167110	
CAT40SLN1-1.75.129		ECB-075277		EHD-P4284		NTS-BT30-SLOT206		00168110	
CAT40SLN1/2129		ECB-120277		EHD-P5284		NTS-HSK63A.206		00170110	
CAT40SLN1/2-1.75129		ECB-210277		EHD-P6284		NTS-HSK63F-36206		00300-02-1110	
CAT40SLN1/4129		EEPM-2540ISP274		EHD-P7284		NTS-HSK63F-38206		00300-02-2110	
CAT40SLN1/4-1.75129		EEPM-2540W-480274		EHD-P8284		NTS-HSK63F-41206		00320110	
CAT40SLN1/8129		EEPM-2580ISP274		EHD-S1284		NTS-HSK63F-46206		00600111	
CAT40SLN3/16.129		EEPM-2580W-480274		EHD-S2284		NTS-ISO20-17206		01250-13S.130	
CAT40SLN3/4129		EEPM-3030ISP274		EHD-S3284		NTS-ISO20-22206		01250-13S.204	
CAT40SLN3/4-1.75129		EEPM-3030W-480274		EHD-S4284		NTS-ISO25-27206		01610-1/1671	
CAT40SLN3/8129		EEPM-3060ISP274		EHD-S5284		NTS-ISO30-36206		01610-1/271	
CAT40SLN3/8-1.75129		EEPM-3060W-480274		EHD-S6284		NTS-ISO30-38206		01610-1/471	
CAT40SLN5/8129		EEPM-4040ISP274		EHD-S7284		NTS-ISO30-47206		01610-1/871	
CAT50ER16-4128		EEPM-4040W-480274		EHD-S8284		PFS-747284		01610-11/32.71	
CAT50ER16-6128		EEPM-4080ISP274		EHD-S9284		PFS-7475G.284		01610-11/64.71	
CAT50ER20-4128		EEPM-4080W-480274		ELM-100280		PSC-50.205		01610-13/32.71	
CAT50ER20-6128		EEPM-4090ISP274		ELM-1000280		PSS-30BT205		01610-13/64.71	
CAT50ER32-4128		EEPM-4090W-480274		ELM-1000V281		PSS-30ISO205		01610-15/32.71	
CAT50ER32-6128		EEPM-50100ISP274		ELM-2000280		PSS-40.205		01610-15/64.71	
CAT50ER40-4128		EEPM-50100W -480274		ELM-300280		SDMT09T237		01610-15S.71	
CAT50SLN1129		EEPM-5060ISP274		ELM-3000280		SDMT12T237		01610-17/32.71	

01610-17/64 to 04010-37/64

Part No.	Page	Part No.	Page	Part No.	Page	Part No.	Page	Part No.	Page
01610-17/64	71	01618-21/32	71	01620-17S	71	04008-1/4	66	04008-9/16	66
01610-19/64	71	01618-21/64	71	01620-19/64	71	04008-1/8	66	04008-9/32	66
01610-21/64	71	01618-21S	71	01620-21/64	71	04008-11/16	66	04008-9/64	66
01610-21S	71	01618-23/32	71	01620-21S	71	04008-11/32	66	04010-1	67
01610-23/64	71	01618-23/64	71	01620-23/64	71	04008-11/64	66	04010-1/2	67
01610-25/64	71	01618-25/64	71	01620-3/16	71	04008-11S	66	04010-1/4	67
01610-27/64	71	01618-27/64	71	01620-3/32	71	04008-13/32	66	04010-1/8	67
01610-29/64	71	01618-29/64	71	01620-3/64	71	04008-13/64	66	04010-11/16	67
01610-29S	71	01618-3/16	71	01620-3/8	71	04008-15/32	66	04010-11/32	67
01610-3/16	71	01618-3/32	71	01620-5/16	71	04008-15/64	66	04010-11/64	67
01610-3/32	71	01618-3/4	71	01620-5/32	71	04008-17/32	66	04010-13/16	67
01610-3/8	71	01618-3/8	71	01620-5/64	71	04008-17/64	66	04010-13/32	67
01610-31/64	71	01618-31/64	71	01620-7/32	71	04008-19/32	66	04010-13/64	67
01610-33/64	71	01618-33/64	71	01620-7/64	71	04008-19/64	66	04010-15/16	67
01610-33S	71	01618-33S	71	01620-9/32	71	04008-21/32	66	04010-15/32	67
01610-35/64	71	01618-35/64	71	01620-9/64	71	04008-21/64	66	04010-15/64	67
01610-5/16	71	01618-37/64	71	01620-9S	71	04008-22S	66	04010-15S	67
01610-5/32	71	01618-39/64	71	01630-1/16	71	04008-23/32	66	04010-17/32	67
01610-5/64	71	01618-41/64	71	01630-1/4	71	04008-23/64	66	04010-17/64	67
01610-7/16	71	01618-41S	71	01630-1/8	71	04008-25/64	66	04010-19/32	67
01610-7/32	71	01618-43/64	71	01630-11/64	71	04008-27/64	66	04010-19/64	67
01610-7/64	71	01618-45/64	71	01630-13/64	71	04008-29/64	66	04010-21/32	67
01610-8S	71	01618-47/64	71	01630-14S	71	04008-3/16	66	04010-21/64	67
01610-9/16	71	01618-5/16	71	01630-15/64	71	04008-3/32	66	04010-21S	67
01610-9/32	71	01618-5/32	71	01630-3/16	71	04008-3/4	66	04010-23/32	67
01610-9/64	71	01618-5/64	71	01630-3/32	71	04008-3/8	66	04010-23/64	67
01618-1/16	71	01618-5/8	71	01630-3/64	71	04008-31/64	66	04010-25/32	67
01618-1/2	71	01618-7/16	71	01630-5/32	71	04008-33/64	66	04010-25/64	67
01618-1/4	71	01618-7/32	71	01630-5/64	71	04008-35/64	66	04010-27/32	67
01618-1/8	71	01618-7/64	71	01630-7/32	71	04008-37/64	66	04010-27/64	67
01618-11/16	71	01618-9/16	71	01630-7/64	71	04008-39/64	66	04010-29/32	67
01618-11/32	71	01618-9/32	71	01630-7S	71	04008-41/64	66	04010-29/64	67
01618-11/64	71	01618-9/64	71	01630-9/64	71	04008-43/64	66	04010-3/16	67
01618-13/32	71	01618-9S	71	02150	130	04008-43S	66	04010-3/32	67
01618-13/64	71	01620-1/16	71	02151-JT33	130	04008-45/64	66	04010-3/4	67
01618-15/32	71	01620-1/4	71	02153	130	04008-47/64	66	04010-3/8	67
01618-15/64	71	01620-1/8	71	02153-JT33	130	04008-5/16	66	04010-30S	67
01618-17/32	71	01620-11/32	71	03508-5/16	70	04008-5/32	66	04010-31/32	67
01618-17/64	71	01620-11/64	71	03636-NUT	70	04008-5/8	66	04010-31/64	67
01618-17S	71	01620-13/64	71	03690-25	205	04008-7/16	66	04010-33/64	67
01618-19/32	71	01620-15/64	71	03691	204	04008-7/32	66	04010-35/64	67
01618-19/64	71	01620-17/64	71	04008-1/2	66	04008-7/64	66	04010-37/64	67

Part No.	Page	Part No.	Page	Part No.	Page	Part No.	Page	Part No.	Page
04010-39/64	67	04011-1.27/64	69	04011-51/64	69	04211-04.0	50	04216-13/32	48
04010-41/64	67	04011-1.29/64	69	04011-53/64	69	04211-04.5	50	04216-3/16	48
04010-41S	67	04011-1.3/16	69	04011-55/64	69	04211-05.0	50	04216-3/32	48
04010-43/64	67	04011-1.3/32	69	04011-57/64	69	04211-05.5	50	04216-3/8	48
04010-45/64	67	04011-1.3/64	69	04011-59/64	69	04211-06.0	50	04216-5/16	48
04010-47/64	67	04011-1.3/8	69	04011-61/64	69	04211-06.5	50	04216-5/32	48
04010-49/64	67	04011-1.31/64	69	04011-63/64	69	04211-07.0	50	04216-7/32	48
04010-5/16	67	04011-1.5/16	69	04011-65S	69	04211-1/16	48	04216-9/32	48
04010-5/32	67	04011-1.5/32	69	04011-7/32	69	04211-1/4	48	04220-01	50
04010-5/8	67	04011-1.5/64	69	04011-7/8	69	04211-1/8	48	04220-01.5	50
04010-51/64	67	04011-1.7/16	69	04011-9/16	69	04211-3/16	48	04220-02	50
04010-53/64	67	04011-1.7/32	69	04018	204	04211-3/32	48	04220-02.5	50
04010-55/64	67	04011-1.7/64	69	0410-20	69	04211-5/32	48	04220-03	50
04010-57/64	67	04011-1.9/32	69	04200MS	50	04211-7/32	48	04220-03.5	50
04010-59/64	67	04011-1.9/64	69	04201MS	50	04211-9/32	48	04220-04	50
04010-59S	67	04011-1/2	69	04202MS	50	04211IS	48	04220-04.5	50
04010-61/64	67	04011-11/16	69	04203MS	50	04212IS	48	04220-05	50
04010-63/64	67	04011-13/16	69	04204MS	50	04213IS	48	04220-05.5	50
04010-7/16	67	04011-15/16	69	04205MS	50	04216-01	50	04220-06	50
04010-7/32	67	04011-17/32	69	04206MS	50	04216-01.5	50	04220-06.5	50
04010-7/64	67	04011-17/64	69	04207MS	50	04216-02	50	04220-07	50
04010-7/8	67	04011-17S	69	04208-01.0	50	04216-02.5	50	04220-07.5	50
04010-9/16	67	04011-19/32	69	04208-01.5	50	04216-03	50	04220-08	50
04010-9/32	67	04011-21/32	69	04208-02.0	50	04216-03.5	50	04220-08.5	50
04010-9/64	67	04011-23/32	69	04208-02.5	50	04216-04	50	04220-09	50
04011-1	69	04011-25/32	69	04208-03.0	50	04216-04.5	50	04220-09.5	50
04011-1.1/16	69	04011-27/32	69	04208-03.5	50	04216-05	50	04220-1/16	48
04011-1.1/2	69	04011-29/32	69	04208-04.0	50	04216-05.5	50	04220-1/2	48
04011-1.1/4	69	04011-3/4	69	04208-04.5	50	04216-06	50	04220-1/4	48
04011-1.1/64	69	04011-3/8	69	04208-05.0	50	04216-06.5	50	04220-1/8	48
04011-1.1/8	69	04011-31/32	69	04208-1/16	48	04216-07	50	04220-10	50
04011-1.11/32	69	04011-33/64	69	04208-1/8	48	04216-07.5	50	04220-10.5	50
04011-1.11/64	69	04011-33S	69	04208-3/16	48	04216-08	50	04220-11	50
04011-1.13/32	69	04011-35/64	69	04208IS	48	04216-08.5	50	04220-11.5	50
04011-1.13/64	69	04011-37/64	69	04209IS	48	04216-09	50	04220-11/32	48
04011-1.15/32	69	04011-39/64	69	04210IS	48	04216-09.5	50	04220-12	50
04011-1.15/64	69	04011-41/64	69	04211-01.0	50	04216-1/16	48	04220-12.5	50
04011-1.17/64	69	04011-43/64	69	04211-01.5	50	04216-1/4	48	04220-13	50
04011-1.19/64	69	04011-45/64	69	04211-02.0	50	04216-1/8	48	04220-13.5	50
04011-1.21/64	69	04011-47/64	69	04211-02.5	50	04216-10	50	04220-13/32	48
04011-1.23/64	69	04011-49/64	69	04211-03.0	50	04216-10.5	50	04220-14	50
04011-1.25/64	69	04011-5/8	69	04211-03.5	50	04216-11/32	48	04220-15/32	48

Part No.	Page	Part No.	Page	Part No.	Page	Part No.	Page	Part No.	Page
04220-3/16	48	04225-7/32	49	04232-18	51	04240-16	51	04250-20	51
04220-3/32	48	04225-9/16	49	04232-18.5	51	04240-17	51	04250-22	51
04220-3/8	48	04225-9/32	49	04232-19	51	04240-17/32	49	04250-24	51
04220-5/16	48	04232-03	51	04232-19.5	51	04240-18	51	04250-26	51
04220-5/32	48	04232-03.5	51	04232-19/32	49	04240-19	51	04250-28	51
04220-7/16	48	04232-04	51	04232-20	51	04240-19/32	49	04250-3/4	49
04220-7/32	48	04232-04.5	51	04232-21	51	04240-20	51	04250-30	51
04220-9/32	48	04232-05	51	04232-21/32	49	04240-21	51	04250-32	51
04225-02	51	04232-05.5	51	04232-23/32	49	04240-21/32	49	04250-34	51
04225-02.5	51	04232-06	51	04232-3/16	49	04240-22	51	04250-5/8	49
04225-03	51	04232-06.5	51	04232-3/32	49	04240-23	51	04250-7/8	49
04225-03.5	51	04232-07	51	04232-3/4	49	04240-23/32	49	04282	61
04225-04	51	04232-07.5	51	04232-3/8	49	04240-24	51	04284	61
04225-05	51	04232-08	51	04232-5/16	49	04240-25	51	04286	61
04225-06	51	04232-08.5	51	04232-5/32	49	04240-25/32	49	04286-12	61
04225-07	51	04232-09	51	04232-5/8	49	04240-26	51	04288	61
04225-08	51	04232-09.5	51	04232-7/16	49	04240-27/32	49	04290	61
04225-09	51	04232-1/16	49	04232-7/32	49	04240-29/32	49	04292	61
04225-1/2	49	04232-1/2	49	04232-9/16	49	04240-3/16	49	04292-22	61
04225-1/4	49	04232-1/4	49	04232-9/32	49	04240-3/4	49	04294	61
04225-1/8	49	04232-1/8	49	04240-04	51	04240-3/8	49	04294-13	61
04225-10	51	04232-10	51	04240-05	51	04240-31/32	49	04296	61
04225-11	51	04232-10.5	51	04240-06	51	04240-5/16	49	04448	61
04225-11/32	49	04232-11	51	04240-07	51	04240-5/32	49	04449	61
04225-12	51	04232-11.5	51	04240-08	51	04240-5/8	49	04450	61
04225-13	51	04232-11/16	49	04240-09	51	04240-7/16	49	04451	61
04225-13/32	49	04232-11/32	49	04240-1	49	04240-7/32	49	04452	61
04225-14	51	04232-12	51	04240-1/2	49	04240-7/8	49	04453	61
04225-15	51	04232-12.5	51	04240-1/4	49	04240-9/16	49	04454	61
04225-15/32	49	04232-13	51	04240-1/8	49	04240-9/32	49	04455	61
04225-16	51	04232-13.5	51	04240-10	51	04250-06	51	04456	61
04225-17	51	04232-13/32	49	04240-11	51	04250-07	51	04457	61
04225-17/32	49	04232-14	51	04240-11/16	49	04250-08	51	04459	61
04225-19/32	49	04232-14.5	51	04240-11/32	49	04250-09	51	04460	61
04225-3/16	49	04232-15	51	04240-12	51	04250-1	49	04461	61
04225-3/32	49	04232-15.5	51	04240-13	51	04250-1-1/4	49	04462	61
04225-3/4	49	04232-15/32	49	04240-13/16	49	04250-1/2	49	04464	61
04225-3/8	49	04232-16	51	04240-13/32	49	04250-10	51	04466	61
04225-5/16	49	04232-16.5	51	04240-14	51	04250-12	51	04468	61
04225-5/32	49	04232-17	51	04240-15	51	04250-14	51	04470	61
04225-5/8	49	04232-17.5	51	04240-15/16	49	04250-16	51	04472	61
04225-7/16	49	04232-17/32	49	04240-15/32	49	04250-18	51	04474	61

Part No.	Page	Part No.	Page	Part No.	Page	Part No.	Page	Part No.	Page
04476	61	04544-13/32	54	04546-04	55	04547-1/2	54	04610	.204
04478	61	04544-15/32	54	04546-05	55	04547-10	55	04613	.204
04480	61	04544-3/16	54	04546-06	55	04547-11	55	04614	.204
04482	61	04544-3/8	54	04546-07	55	04547-11/16	54	04615	.204
04484	61	04544-5/16	54	04546-08	55	04547-12	55	04616	.204
04486	61	04544-5/32	54	04546-09	55	04547-13	55	04617	.204
04543-03	55	04544-7/16	54	04546-1/2	54	04547-13/32	54	04618	.204
04543-04	55	04544-7/32	54	04546-1/4	54	04547-14	55	04620	.204
04543-05	55	04544-9/32	54	04546-10	55	04547-15	55	04621	.204
04543-06	55	04544IS	54	04546-11	55	04547-15/32	54	04622	.204
04543-07	55	04544MS	55	04546-11/16	54	04547-16	55	04623	.204
04543-08	55	04545-03	55	04546-11/32	54	04547-17	55	04624	.204
04543-09	55	04545-04	55	04546-12	55	04547-17/32	54	04782	43
04543-1/4	54	04545-05	55	04546-13	55	04547-18	55	04784	43
04543-1/8	54	04545-06	55	04546-13/32	54	04547-19	55	04786	43
04543-10	55	04545-07	55	04546-14	55	04547-19/32	54	04788	43
04543-11/32	54	04545-08	55	04546-15	55	04547-20	55	04790	43
04543-13/32	54	04545-09	55	04546-15/32	54	04547-21/32	54	04801-DE	43
04543-3/16	54	04545-1/2	54	04546-16	55	04547-23/32	54	04802-C	43
04543-3/32	54	04545-1/4	54	04546-17	55	04547-25	55	04802-DE	43
04543-3/8	54	04545-10	55	04546-17/32	54	04547-3/4	54	04803-C	43
04543-5/16	54	04545-11	55	04546-18	55	04547-3/8	54	04803-DE	43
04543-5/32	54	04545-11/32	54	04546-19	55	04547-5/8	54	04804-C	43
04543-7/32	54	04545-12	55	04546-19/32	54	04547-7/16	54	04804-DE	43
04543-9/32	54	04545-13	55	04546-20	55	04547-7/8	54	04805-C	43
04543IS	54	04545-13/32	54	04546-21/32	54	04547-9/16	54	04806-C	43
04543MS	55	04545-14	55	04546-23/32	54	04547IS	54	04808-C	43
04544-03	55	04545-15	55	04546-3/4	54	04576	.205	04817	42
04544-04	55	04545-15/32	54	04546-3/8	54	04577	.205	04818	42
04544-05	55	04545-16	55	04546-5/16	54	04578	.205	04832	42
04544-06	55	04545-17/32	54	04546-5/8	54	04580-16	.205	04834	42
04544-07	55	04545-19/32	54	04546-7/16	54	04580-20	.205	04835	42
04544-08	55	04545-3/8	54	04546-7/32	54	04587	.205	04836-2.5	42
04544-09	55	04545-5/16	54	04546-9/16	54	04601-16	.205	04837	42
04544-1/2	54	04545-5/8	54	04546-9/32	54	04602-20	.205	04839	42
04544-1/4	54	04545-7/16	54	04546IS	54	04603-25	.205	04839-140	42
04544-1/8	54	04545-7/32	54	04546MS	55	04604-32	.205	04841	42
04544-10	55	04545-9/16	54	04547-06	55	04604-32	.205	04843	42
04544-11	55	04545-9/32	54	04547-07	55	04605-40	.205	04851	42
04544-11/32	54	04545IS	54	04547-08	55	04608	52	04854	42
04544-12	55	04545MS	55	04547-09	55	04608	.204	04855	42
04544-13	55	04546-03	55	04547-1	54	04609	.204	04856	42

Part No.	Page	Part No.	Page	Part No.	Page	Part No.	Page	Part No.	Page
04858	42	05410-9(SET)	58	05570-437	58	05802-255	60	05916-220	57
04881	42	05428-DIN	59	05570-480	58	05802-4(SET)	60	05916IS	57
04888	42	05434-DIN	59	05570-542	58	05804-168	60	05920-141	57
04889	42	05436	59	05570-562	58	05804-194	60	05920-168	57
04891	42	05442-DIN	59	05570-590	58	05804-220	60	05920-194	57
04892	42	05446-DIN	59	05570-652	58	05804-255	60	05920-220	57
04893	42	05448-DIN	59	05586-DIN	59	05804-318	60	05920-255	57
04894	42	05456-DIN	59	05598-M9	59	05804-323	60	05920IS	57
04895	42	05510-11(SET)	58	05600-DIN	59	05804-367	60	05925-141	57
04896	42	05510-141	58	05600-JIS	59	05804-381	60	05925-168	57
04897	42	05510-168	58	05604-DIN	59	05804-8(SET)	60	05925-194	57
04898	42	05510-194	58	05606-DIN	59	05806-168	60	05925-220	57
05320-141	58	05510-220	58	05610	59	05806-194	60	05925-225	57
05320-168	58	05510-255	58	05614-DIN	59	05806-220	60	05925-318	57
05320-194	58	05510-318	58	05620-DIN	59	05806-255	60	05925-323	57
05320-220	58	05510-323	58	05624-DIN	59	05806-318	60	05925-367	57
05320-255	58	05510-367	58	05633	59	05806-323	60	05925-381	57
05320-318	58	05510-381	58	05710-141	58	05806-367	60	05925IS	57
05320-323	58	05510-429	58	05710-168	58	05806-381	60	05932-168	57
05320-367	58	05510-437	58	05710-194	58	05806-429	60	05932-194	57
05320-381	58	05510-480	58	05710-21(SET)	58	05806-437	60	05932-220	57
05320-5(SET)	58	05510-542	58	05710-220	58	05806-480	60	05932-255	57
05320-9(SET)	58	05526-DIN	59	05710-255	58	0580611IS	60	05932-318	57
05326-DIN	59	05534-DIN	59	05710-318	58	05808-15(SET)	60	05932-323	57
05330-DIN	59	05540-DIN	59	05710-323	58	05808-168	60	05932-367	57
05336-DIN	59	05542-DIN	59	05710-367	58	05808-194	60	05932-381	57
05342-DIN	59	05548-DIN	59	05710-381	58	05808-220	60	05932-429	57
05350-DIN	59	05550	59	05710-429	58	05808-255	60	05932-437	57
05352	59	05550-DIN	59	05710-437	58	05808-318	60	05932-480	57
05354-DIN	59	05554-DIN	59	05710-480	58	05808-323	60	05932IS	57
05356-DIN	59	05558-DIN	59	05710-542	58	05808-367	60	05952-02	52
05371	59	05570-141	58	05710-562	58	05808-381	60	05952-03	52
05385	59	05570-16(SET)	58	05710-590	58	05808-429	60	05952-03.5	52
05410-141	58	05570-168	58	05710-652	58	05808-437	60	05952-04	52
05410-168	58	05570-194	58	05710-687	58	05808-480	60	05952-05	52
05410-194	58	05570-220	58	05710-697	58	05808-542	60	05952-06	52
05410-220	58	05570-255	58	05710-700	58	05808-562	60	05952-1/4	52
05410-255	58	05570-318	58	05710-760	58	05808-590	60	05952-1/8	52
05410-318	58	05570-323	58	05710-800	58	05808-652	60	05952-3/16	52
05410-323	58	05570-367	58	05802-168	60	05916-141	57	05954-0.3	52
05410-367	58	05570-381	58	05802-194	60	05916-168	57	05954-0.4	52
05410-381	58	05570-429	58	05802-220	60	05916-194	57	05954-0.5	52

Part No.	Page	Part No.	Page	Part No.	Page	Part No.	Page	Part No.	Page
05954-0.6	52	05958-3.5	53	08320-03.5	56	08325-11.5	56	08332-17.5	56
05954-0.8	52	05958-3/16	53	08320-04.0	56	08325-12.0	56	08332-18.0	56
05954-02	52	05958-3/4	53	08320-04.5	56	08325-12.5	56	08332-18.5	56
05954-03	52	05958-3/8	53	08320-05.0	56	08325-13.0	56	08332-19	56
05954-04	52	06032	23	08320-05.5	56	08325-13.5	56	08332-19.5	56
05954-05	52	06032-3	23	08320-06.0	56	08325-14.0	56	08332-20.0	56
05954-06	52	06034	23	08320-06.5	56	08325-14.5	56	08332-3/4	56
05954-07	52	06038	23	08320-07.0	56	08325-15.0	56	08332-35MS	56
05954-08	52	06040	23	08320-07.5	56	08325-15.5	56	08340-06.0	56
05954-09	52	06042	23	08320-08.0	56	08325-16.0	56	08340-06.5	56
05954-1.0	52	06291	36	08320-08.5	56	08325MS	56	08340-07.0	56
05954-1.2	52	06456	130	08320-09.0	56	08332-03.0	56	08340-07.5	56
05954-1.25	52	06476	130	08320-09.5	56	08332-03.5	56	08340-08.0	56
05954-1.5	52	07801	203	08320-1/2	56	08332-04.0	56	08340-08.5	56
05954-1.75	52	07806	203	08320-1/4	56	08332-04.5	56	08340-09.0	56
05954-1/4	52	07812	203	08320-10.0	56	08332-05.0	56	08340-09.5	56
05954-1/8	52	07852	206	08320-10.5	56	08332-05.5	56	08340-1	56
05954-10	52	07854	206	08320-11.0	56	08332-06.0	56	08340-1/2	56
05954-2.25	52	07856	206	08320-11.5	56	08332-06.5	56	08340-1/4	56
05954-2.5	52	07870	206	08320-12.0	56	08332-07.0	56	08340-10.0	56
05954-3.5	52	07872	206	08320-12.5	56	08332-07.5	56	08340-10.5	56
05954-3/16	52	07884	206	08320-13.0	56	08332-08.0	56	08340-11.0	56
05954-3/8	52	07885	206	08320MS	56	08332-08.5	56	08340-11.5	56
05954-4.5	52	07905-2	207	08325-03.0	56	08332-09.0	56	08340-12.0	56
05956-03	53	08316-03.0	56	08325-03.5	56	08332-09.5	56	08340-12.5	56
05956-04	53	08316-03.5	56	08325-04.0	56	08332-1/2	56	08340-13.0	56
05956-05	53	08316-04.0	56	08325-04.5	56	08332-1/4	56	08340-13.5	56
05956-06	53	08316-04.5	56	08325-05.0	56	08332-10.0	56	08340-14.0	56
05956-1/4	53	08316-05.0	56	08325-05.5	56	08332-10.5	56	08340-14.5	56
05956-1/8	53	08316-05.5	56	08325-06.0	56	08332-11.0	56	08340-15.0	56
05956-3.5	53	08316-06.0	56	08325-06.5	56	08332-11.5	56	08340-15.5	56
05956-3/16	53	08316-06.5	56	08325-07.0	56	08332-12.0	56	08340-16.0	56
05956-3/8	53	08316-07.0	56	08325-07.5	56	08332-12.5	56	08340-16.5	56
05958-03	53	08316-07.5	56	08325-08.0	56	08332-13.0	56	08340-17.0	56
05958-04	53	08316-08.0	56	08325-08.5	56	08332-13.5	56	08340-17.5	56
05958-05	53	08316-08.5	56	08325-09.0	56	08332-14.0	56	08340-18.0	56
05958-06	53	08316-09.0	56	08325-09.5	56	08332-14.5	56	08340-18.5	56
05958-1/2	53	08316-09.5	56	08325-1/2	56	08332-15.0	56	08340-19.0	56
05958-1/4	53	08316-1/4	56	08325-1/4	56	08332-15.5	56	08340-19.5	56
05958-1/8	53	08316-10.0	56	08325-10.0	56	08332-16.0	56	08340-20.0	56
05958-13	53	08316MS	56	08325-10.5	56	08332-16.5	56	08340-20.5	56
05958-20	53	08320-03.0	56	08325-11.0	56	08332-17.0	56	08340-21.0	56

Part No.	Page	Part No.	Page	Part No.	Page	Part No.	Page	Part No.	Page
08340-21.5	56	08520-11.0	64	08532-08.0	64	08540-11.5	65	13/0-4041	.142
08340-22.0	56	08520-11.5	64	08532-08.5	64	08540-12.0	65	13/0-4048	.142
08340-22.5	56	08520-12.0	64	08532-09.0	64	08540-12.5	65	13/0-4054	.142
08340-23.0	56	08520-12.5	64	08532-09.5	64	08540-13.0	65	13/0-4063	.142
08340-23.5	56	08520-13.0	64	08532-10.0	64	08540-13.5	65	13001	.203
08340-24.0	56	08520-20(SET)	65	08532-10.5	64	08540-14.0	65	13003	.203
08340-24.5	56	08525-03.5	64	08532-11.0	64	08540-14.5	65	141.122.16.070	.192
08340-25.0	56	08525-04.0	64	08532-11.5	64	08540-15.0	65	141.122.25.055	.192
08340-25.5	56	08525-04.5	64	08532-12.0	64	08540-15.5	65	141.122.32.057	.192
08340-26.0	56	08525-05.0	64	08532-12.5	64	08540-16.0	65	141.151.64.100	.196
08340-3/4	56	08525-05.5	64	08532-13.0	64	08540-16.5	65	141.648.06.075	.195
08340-41MS	56	08525-06.0	64	08532-13.5	64	08540-17.0	65	141.651.54.295	.194
08516-03.5	64	08525-06.5	64	08532-14.0	64	08540-17.5	65	141.651.55.295	.194
08516-04.0	64	08525-07.0	64	08532-14.5	64	08540-18.0	65	141.651.56.295	.194
08516-04.5	64	08525-07.5	64	08532-15.0	64	08540-18.5	65	141.651.58.295	.194
08516-05.0	64	08525-08.0	64	08532-15.5	64	08540-19.0	65	141.651.61.295	.194
08516-05.5	64	08525-08.5	64	08532-16.0	64	08540-19.5	65	141.653.54.197	.193
08516-06.0	64	08525-09.0	64	08532-16.5	64	08540-20.0	65	141.653.55.197	.193
08516-06.5	64	08525-09.5	64	08532-17.0	64	08540-20.5	65	141.653.56.197	.193
08516-07.0	64	08525-10.0	64	08532-17.5	64	08540-21.0	65	141.653.58.217	.193
08516-07.5	64	08525-10.5	64	08532-18.0	64	08540-21.5	65	141.653.61.217	.193
08516-08.0	64	08525-11.0	64	08532-18.5	64	08540-22.0	65	142.122.16.100	.192
08516-08.5	64	08525-11.5	64	08532-19.0	64	08540-22.5	65	142.122.25.052	.192
08516-09.0	64	08525-12.0	64	08532-19.5	64	08540-23.0	65	142.122.32.054	.192
08516-09.5	64	08525-12.5	64	08532-20.0	64	08540-23.5	65	142.151.68.157	.196
08516-10.0	64	08525-13.0	64	08532-34(SET)	65	08540-24.0	65	142.651.52.315	.194
08516-14(SET)	65	08525-13.5	64	08540-03.5	65	08540-24.5	65	142.651.53.315	.194
08520-03.5	64	08525-14.0	64	08540-04.0	65	08540-25.0	65	142.651.54.315	.194
08520-04.0	64	08525-14.5	64	08540-04.5	65	08540-25.5	65	142.651.56.315	.194
08520-04.5	64	08525-15.0	64	08540-05.0	65	08540-26.0	65	142.651.58.315	.194
08520-05.0	64	08525-15.5	64	08540-05.5	65	08540-46(SET)	65	142.651.61.315	.194
08520-05.5	64	08525-16.0	64	08540-06.0	65	11116	.128	142.651.64.315	.194
08520-06.0	64	08525-26(SET)	65	08540-06.5	65	11120	.128	143.122.16.100	.192
08520-06.5	64	08532-03.5	64	08540-07.0	65	11125	.128	143.122.25.060	.192
08520-07.0	64	08532-04.0	64	08540-07.5	65	11132	.128	143.122.32.070	.192
08520-07.5	64	08532-04.5	64	08540-08.0	65	11140	.128	143.122.40.065	.192
08520-08.0	64	08532-05.0	64	08540-08.5	65	1132.0000	53	143.123.08.600	.192
08520-08.5	64	08532-05.5	64	08540-09.0	65	1132.0000C	53	143.123.11.600	.192
08520-09.0	64	08532-06.0	64	08540-09.5	65	12000-CMS	39	143.123.16.600	.192
08520-09.5	64	08532-06.5	64	08540-10.0	65	12040-CMS	39	143.123.20.600	.192
08520-10.0	64	08532-07.0	64	08540-10.5	65	12194-ISO25	39	143.151.64.100	.196
08520-10.5	64	08532-07.5	64	08540-11.0	65	13/0-4036	.142	143.151.68.200	.196

Part No.	Page	Part No.	Page	Part No.	Page	Part No.	Page	Part No.	Page
143.151.72.200	196	1506501	223	16103	29	16185	32	16502	131
143.475.12L.065	197	1506501	238	16104	29	16189	32	16504	131
143.475.12R.065	197	1506505	223	16105	29	16251	36	16506	131
143.476.15L.075	197	1506505	238	16106	29	16252	36	1651236	236
143.476.15R.075	197	16000-2016MC	39	16106-W	40	16253	36	16522	131
143.478.08L.065	197	16000-2516	39	16107	29	16254	36	1652236	236
143.478.08R.065	197	16000-2520	39	16108-2.5	29	16255	36	16523	131
143.479.16L.075	198	16001	40	16109	29	16263	36	16524	131
143.479.16R.075	198	16001-W	40	16110	29	16265	36	16542	131
143.481.15N.100	198	16010	40	16111	29	16267	36	16543	131
143.648.06.080	195	16080C-20	45	16111-90	29	16271	36	1654345	232
143.651.52.300	194	16080C-20	108	16112	29	16275	36	16544	131
143.651.53.300	194	16080C-20	208	16113	29	16277	36	1655345	232
143.651.54.315	194	16081	208	16114	29	16279	36	1658810	237
143.651.55.315	194	16082C-20	45	16115	29	16281	36	16611	118
143.651.56.315	194	16082C-20	108	16121	40	16283	36	16612	118
143.651.58.315	194	16082C-20	208	16131	40	16284	36	1661237	236
143.651.61.335	194	16083	208	16151	32	16285	36	16614	118
143.651.64.335	194	16083C-20	45	16151F	33	16289	36	16615	119
143.651.68.354	194	16083C-20	108	16153	32	16302	29	16615-3/4	119
143.651.72.374	194	16083C-20	208	16153F	33	16304	29	16615-4	119
143.653.54.217	193	16085	208	16155	32	16308	29	16615-6	119
143.653.55.217	193	16085C-20	45	16157	32	16312	29	16617	119
143.653.56.236	193	16085C-20	108	16157F	33	1631234	236	16620	119
143.653.58.236	193	16085C-20	208	16158	32	16313	29	16620-4	119
143.653.61.256	193	16087	208	16159	32	16314	29	1662237	236
143.653.64.256	193	16088	208	16159F	33	16318	29	16626	119
143.653.68.315	193	16089	208	16162	32	16321	34	16639	119
1500300	223	16089C-20	45	16162F	33	1632234	236	16639-3	119
1500300	238	16089C-20	108	16165	32	1632345	232	16642	119
1501567	223	16089C-20	208	16167	32	16324	34	16645	119
1501567	238	16091	208	16167F	33	16325	34	16646	119
1506065	223	16091C-20	45	16169	32	16328	34	16646105	119
1506065	238	16091C-20	108	16171	32	16328-200	34	16646150	119
1506073	223	16091C-20	208	16175	32	16329	34	16648	119
1506073	238	16092	208	16177	32	16330	34	1665345	232
1506077	223	16093	208	16177F	33	16332	34	1666345	232
1506077	238	16094	208	16177S	35	1633345	232	1668820	237
1506082	223	16096	208	16179	32	1641235	236	1668822	237
1506082	238	161-BT35-ER32 76	40	16181	32	1642235	236	1672238	236
1506085	223	16101	29	16181F	33	16456-W	130	1676238	236
1506085	238	16102	29	16183	32	16466	130	1678830	237

Part No.	Page	Part No.	Page	Part No.	Page	Part No.	Page	Part No.	Page
1678840237	17140-1/2	86	17707207	18851-11/64	23	19140102
1682239236	17140-1/2-4	87	17708207	18851-13/64	23	19140-135102
1686239236	17140-1/2-4.72-RR	87	1771284244	18851-15/64	23	19142102
1688850237	17140-1/2F	88	1771294244	18851-3/16	23	19142-135102
17001125	17140-1/4	86	17801201	18851-3/32	23	19462-06127
17006125	17140-1/4-4	87	17803201	18851-5/32	23	19462-08127
17010125	17140-1/4-4.72-RR	87	17805201	18851-7/32	23	19462-1/2127
17011125	17140-1/4F	88	17806201	18851-7/64	23	19462-1/4127
17014125	17140-1/8	86	17808201	18851-9/64	23	19462-10127
17018125	17140-1/8-4	87	17810201	18854	31	19462-12127
17023125	17140-1/8-5.0-RR	87	17812201	18856	31	19462-14127
17036125	17140-1F	88	1781334244	18866	31	19462-16127
17039125	17140-3/16	86	1781354244	18868	31	19462-3/8127
17042125	17140-3/16-4	87	1781374244	18868-150	31	19462-5/16127
17046125	17140-3/16-4.72-RR	87	17814201	18869	31	19462-5/8127
17048125	17140-3/4	86	17816201	19/1 - 4097142	19462-7/16127
17051125	17140-3/4-4	87	17817201	19/1-4036142	19474-1/2127
17053125	17140-3/4-6-RR	87	17818201	19/1-4041142	19474-1/4127
171.05.046.003130	17140-3/4F	88	17820201	19/1-4048142	19474-1/8127
17130-1/2	85	17140-3/8	86	17822201	19/1-4054142	19474-3/16127
17130-1/4	85	17140-3/8-4	87	17824201	19/1-4063142	19474-3/8127
17130-1/8	85	17140-3/8-4.72-RR	87	17826201	19/1-4079142	19474-5/16127
17130-3/16	85	17140-3/8F	88	17828201	19/1-4095142	19474-5/8127
17130-3/4	85	17140-5/16	86	17834201	19/1-4111142	19474-7/16127
17130-3/8	85	17140-5/8	86	17836201	19/1-4127142	19478-01127
17130-5/16	85	17140-5/8-4	87	17883206	19/1-4142142	19478-1/2127
17130-5/8	85	17140-5/8F	88	17893206	19/11-4036143	19478-1/4127
17130-7/16	85	17140-7/16	86	17906-04207	19/11-4041143	19478-3/4127
17131	86	17140-7/8-5	87	17906-2207	19/11-4048143	19478-3/8127
17132	86	17150-1-1/4-4.5	89	1791394244	19/11-4054143	19478-5/16127
17133	86	17150-1-4.5	89	17937126	19/11-4063143	19478-5/8127
17134	86	17150-1-6	89	17954126	19/11-4079143	19478-7/8127
17135	86	17150-1/2	89	17955126	19/11-4095143	19489G123
17135-18	86	17150-1/4	89	18593	89	19/11-4097143	19496G123
17136	86	17150-3/4	89	18743-12IMS	23	19/11-4111143	200.001.018110
17137	86	17150-3/8	89	18851-03	23	19/11-4127143	200TH205
17138	86	17150-5/8	89	18851-04	23	19/11-4142143	2011.0000	52
17140-1	86	1741234244	18851-05	23	19/11-SET143	2016-2000	53
17140-1-1/2	86	1751244244	18851-05.5	23	19029102	2020.0000	53
17140-1-1/4	86	1751254244	18851-06	23	19136-135102	2020.0000C	53
17140-1-1/4F	88	1761264244	18851-1/4	23	19138102	21003200
17140-1-5	87	17706207	18851-1/8	23	19138-135102	21003-45200

Part No.	Page	Part No.	Page	Part No.	Page	Part No.	Page	Part No.	Page
21003-45C	200	21680/H63A	141	22259	18	22354-8.5	20	22717	114
21003-45CSF	200	21680/INC1	141	22259F	19	22356	20	22717-4	114
21003-60	200	2169940	220	22261	18	22358	20	22719	116
21003-60C	200	21880/40BT	140	22261F	19	22359	20	22721	116
21003-60CSF	200	21880/40CAT	140	22263	18	22359-8	20	22721-10	116
21003-90	200	21880/50BT	140	22263F	19	22360	20	22721-3.5	116
21003-90C	200	21880/50CAT	140	22265	18	22362	20	22721-5.5	116
21003-90CSF	200	21880/H100A	141	22269	18	22364	26	22721-8	116
21003-C	200	21880/H63A	141	22281	24	22366	26	22723	116
21005	200	21880/INC1-1/2	141	22281F	25	22368	26	22723-10	116
21005-45	200	22213-3	18	22285	24	22370	26	22723-4	116
21005-45C	200	22220	204	22285F	25	22403	130	22723-6	116
21005-60	200	22225	18	22287	24	22405	130	22723-8	116
21005-60C	200	22225F	19	22291	24	22511	131	22725	116
21005-90	200	22227	18	22291F	25	22512	131	22725-3.5	116
21005-90C	200	22227F	19	22293	24	22513	131	22725-6	116
21005-C	200	22231	18	22293F	25	22515	131	22725-8	116
21006-15	200	22231F	19	22295	24	22521	131	22727	116
21006-15C	200	22233	18	22295F	25	22523	131	22727-4	116
21007-15	200	22233F	19	22303	24	22525	131	22727-6	116
21007-15C	200	22235	18	22303F	25	22527	131	22727-8	116
21008-15	200	22235F	19	22305	24	22529	131	22729	116
21008-15C	200	22237	18	22307	24	22531	131	22729-4	116
2139910	220	22237F	19	22307-9	24	22611	125	22907	74
21480/30BT	140	22239	18	22311	24	22613	125	22907-1.75	74
21480/40BT	140	22239F	19	22311F	25	22615	125	22907-5.00-RR	75
21480/40CAT	140	22243	18	22311S	27	22617	125	22907-6	75
21480/50BT	140	22243-2.5	18	22313	24	22623	125	22909	74
21480/50CAT	140	22243F	19	22313F	25	22625	125	22909-1.75	74
21480/H100A	141	22245	18	22317	24	22627	125	22909-4.72-RR	75
21480/H50A	141	22245F	19	22317F	25	22629	125	22909-6	75
21480/H63A	141	22247	18	22321	24	22709	114	22909-6B	76
21480/INC1	141	22247F	19	22321F	25	22709-4	114	22909-6FB	78
2149920	220	22251	18	22325	24	22711	114	22911	74
2159930	220	22251F	19	22327	24	22711-4	114	22911-1.75	74
21680/30BT	140	22253	18	22327F	25	22711-6	114	22911-2.5	74
21680/40BT	140	22253F	19	22331	24	22713	114	22911-2.5B	76
21680/40CAT	140	22253S	21	22335	24	22713-4	114	22911-2.5F	77
21680/50BT	140	22255	18	22337	24	22713-6	114	22911-2.5FB	78
21680/50CAT	140	22255F	19	22352	20	22715	114	22911-4.72-RR	75
21680/H100A	141	22257	18	22354	20	22715-4	114	22911-4FB	78
21680/H50A	141	22257F	19	22354-6	20	22715-6	114	22911-6	75

22911-6B to 23400-50CAT

Part No.	Page	Part No.	Page	Part No.	Page	Part No.	Page	Part No.	Page
22911-6B	76	22919B	76	22935-2.5B	82	22941-8	81	22965	74
22911-6FB	78	22919F	77	22935-6	81	22941-8B	82	22967	74
22911F	77	22920	74	22935-6.5-RR	81	22941B	82	22969	74
22913	74	22920-5.75	75	22935-6B	82	22941F	83	22971	74
22913-1.75	74	22920-6FB	78	22935-8B	82	22943	80	22973	74
22913-2.5	74	22921	74	22935B	82	22943-6	81	22975	74
22913-2.5F	77	22921-1.75	74	22935F	83	22943-6B	82	22977	74
22913-4.72-RR	75	22921-1.75B	76	22936-8	81	22943-8	81	22981	80
22913-6FB	78	22921-1.75F	77	22937	80	22943-8B	82	22983	80
22913F	77	22921-3	74	22937-2 5/8	80	22945	80	22985	80
22915	74	22921-3B	76	22937-2.625B	82	22945-2.62	80	22987	80
22915-1.75	74	22921-3F	77	22937-6	81	22945-2.62F	83	22989	80
22915-2.5	74	22921-3FB	78	22937-6.5-RR	81	22945-6	81	22990	80
22915-2.5B	76	22921-4B	76	22937-6B	82	22945-6B	82	22993	80
22915-2.5F	77	22921-5	75	22937-6F	83	22945-8-RR	81	22996	80
22915-2.5FB	78	22921-5F	77	22937-8	81	22945B	82	23008	44
22915-4.72-RR	75	22923	74	22937-8B	82	22945F	83	23014	44
22915-4B	76	22925	74	22937-8F	83	22946-8	81	23014F	44
22915-5	75	22925-1.75F	77	22937B	82	22946-8B	82	23016	44
22915-5F	77	22925-3	74	22937F	83	22947	80	23016F	44
22915-5FB	78	22925-6	75	22939	80	22947-2.62	80	23018	44
22915F	77	22925A-1.75	74	22939-1.44	80	22947-2.62B	82	23018F	44
22916-1.75	74	22925B	76	22939-3	80	22947-6	81	23030	44
22916-2.5	74	22925F	77	22939-3B	82	22947-6B	82	23030F	44
22916-7/16-2.5F	77	22925FB	78	22939-6	81	22947-8	81	23032	44
22917	74	22927	74	22939-6B	82	22947-8B	82	23034	44
22917-1.75	74	22927-4	74	22939-7.25-RR	81	22947B	82	23035	44
22917-2.5	74	22927-6	75	22939-8	81	22947F	83	23108	63
22917-2.5B	76	22927A-2	74	22939-9/16-1.44	80	22949	80	23111	63
22917-2.5FB	78	22927F	77	22939-9/16-3	80	22949-2	80	23116	63
22917-2.63	74	22929	74	22939B	82	22949B	82	23120	63
22917-4.63	75	22929F	77	22939F	83	22949F	83	23125	63
22917-4.72-RR	75	22931	80	22941	80	22951	81	23202G	122
22917-4B	76	22931-2 1/2	80	22941-1.44	80	22951B	82	23210G	122
22917-4FB	78	22931-2.5B	82	22941-1.44B	82	22954-5/16	89	2321234	212
22917B	76	22931-6.5-RR	81	22941-3	80	22955-1/4	89	23214G	122
22917F	77	22931-6B	82	22941-3B	82	22956-5/16	89	23222G	122
22919	74	22931B	82	22941-3F	83	22957-5/16	89	2331235	212
22919-1.75	74	22931F	83	22941-5.75	81	22958-5/16	89	23400-30BT	136
22919-1.75F	77	22933	80	22941-6	81	22959-3/8	89	23400-40BT	136
22919-1.75FB	78	22935	80	22941-6B	82	22959-7/16	89	23400-40CAT	136
22919-4B	76	22935-2 1/2	80	22941-7.25-RR	81	22963	74	23400-50CAT	136

Part No.	Page	Part No.	Page	Part No.	Page	Part No.	Page	Part No.	Page
23400-HS3A	136	2641236	216	29027	92	29060B	100	29252	99
23400-INC1	136	2651237	216	29027F	95	29062	98	29252B	100
23410-ER16	136	27116	53	29027FB	96	29062-6	98	29254	99
23411-MOD	137	27116-30	53	29029	93	29062-6B	100	29254-8	99
2341236	212	27116-40	53	29029B	95	29062B	100	29256	99
2351237	212	27116-45	53	29030	93	29064	98	29258	99
23600-40BT	136	27116-50	53	29032	92	29064-6	98	29258-8	99
23600-40CAT	136	27116-55	53	29032FB	96	29064B	100	29260	99
23600-50CAT	136	27116-60	53	29033B	95	29066-10	98	29260B	100
23600-INC2	136	27116-65	53	29034	92	29066B	100	29262	99
23610-ER25	136	27216	53	29036	92	29068	98	29264	99
23611-MOD	137	28110	67	29036B	95	29068B	100	29266	99
23616	63	28210	68	29036FB	96	29070	98	29266-8	99
23620	63	29002	92	29037	93	29070B	100	29268	99
23625	63	29002FB	96	29037B	95	29072	98	29270	99
23654	23	29004	93	29038	93	29072B	100	29272	99
23656	23	29004B	95	29040	92	29074	98	29274	99
23658	23	29006	92	29040F	95	29076	98	29276	99
23659	23	29006FB	96	29042	92	29103	93	29278-100	99
23672	23	29008	93	29042F	95	29104	93	29280	99
23676	23	29008B	95	29042FB	96	29106	93	29282	99
2421234	213	29010	92	29044	93	29116	63	2928860	221
2431235	213	29011	92	29046	92	29132	63	2928865	221
2441236	213	29011F	95	29046F	95	29204	94	2938870	221
2451237	213	29011FB	96	29051	98	29206	94	29827	205
24937	126	29013	93	29052	98	29208	94	29828	205
24954	126	29014	93	29052-6	98	29210	94	30000	41
2502115	218	29014B	95	29054	98	29212	94	30001	41
2502115	223	29016	92	29054-6	98	29214	94	30001-L	41
2502115	235	29016FB	96	29054-6B	100	29216	94	30002	41
2502115	238	29018	93	29054-8	98	29218	94	30003	41
2506169	223	29018B	95	29054B	100	29220	94	30005	41
2506169	238	29020	92	29056	98	29222	94	300TH	205
2506509	223	29021	92	29058	98	29224	94	31/12-4079	143
2506509	238	29021F	95	29058-6	98	29226	94	31/12-4095	143
25077	39	29021FB	96	29058-6B	100	29228	94	31/12-4111	143
2521234	217	29023	93	29058-8	98	29230	94	31/12-4127	143
2531235	217	29023B	95	29058B	100	29232	94	31/12-4131C	143
2541236	217	29023FB	96	29060	98	29234	94	31/12-4142	143
2551237	217	29024	93	29060-6	98	29236	94	31/12-4158	143
2621234	216	29025	92	29060-6B	100	29238	94	31/12-4166C	143
2631235	216	29026	92	29060-8	98	29240	94	31/12-4174	143

Part No.	Page	Part No.	Page	Part No.	Page	Part No.	Page	Part No.	Page
31/12-4190C	143	31468	37	3253310	221	32994	90	3533030	171
31/12-4206C	143	31472	37	3253310	223	32996	90	3533030	256
31/12-4209C	143	31472-E	41	3253310	238	32998	90	3533030	259
31/12-4222C	143	31484	37	3253320	221	33108	63	3533090	256
31/13-SET	143	31486	37	3253320	223	33111	63	3533090	259
31/2-4079	142	31498	37	3253320	238	33116	63	35470	38
31/2-4095	142	31503	37	3254411	223	33120	63	35472	38
31/2-4111	142	31506	37	3254411	238	33125	63	3563311	171
31/2-4127	142	3151236	223	3254415	223	33125-L	63	3563336	256
31/2-4131C	142	3151236	238	3254415	238	33236G	122	3563336	259
31/2-4142	142	3151239	223	3254431	223	33256G	122	3563337	171
31/2-4158	142	3151239	238	3254431	238	3355525	223	3563337	256
31/2-4166C	142	31528	93	3254435	223	3355525	238	3563337	259
31/2-4174	142	3153311	223	3254435	238	3355531	223	3563388	171
31/2-4190	142	3153311	238	32600/30BT	138	3355531	238	3563399	171
31/2-4206	142	3153321	223	32600/40BT	138	3355541	223	3564431	256
31/2-4209C	142	3153321	238	32600/40CAT	138	3355541	238	3564431	259
31/2-4222	142	3153325	223	32600/50BT	138	34400/H100A	139	3564435	256
31025F	41	3153325	238	32600/50CAT	138	34400/H40A	139	3564435	259
31278	37	31538	93	32600/INC1	139	34400/H50A	139	3564438	171
31284	37	3154411	223	32600/INC1-1/2	139	34400/H63A	139	3564438	256
31374	37	3154411	238	3263311	259	3441111	244	3564438	259
31374-60-E	41	3154422	223	3263322	259	3441121	244	3564441	171
31376	37	3154422	238	32800/40BT	138	3441125	244	3564441	256
31376-E	41	3154433	223	32800/40CAT	138	3441131	244	3564441	259
31383-E	41	3154433	238	32800/50BT	138	3441135	244	3567711	259
31384	37	3154444	223	32800/50CAT	138	3451112	223	3567721	259
31385	37	3154444	238	32800/INC1-1/2	139	3451112	238	3567735	259
31386-E	41	3154455	223	32900/40BT	138	34600/H100A	139	3567741	223
31402-E	41	3154455	238	32900/40CAT	138	34600/H50A	139	3567741	238
31419-E	41	31548	93	32900/50BT	138	34600/H63A	139	3567745	223
31419-F	41	31568	93	32900/50CAT	138	3463311	260	3567745	238
31420	37	31588	93	32954	90	3463315	260	3567751	223
31431-F	41	32400/30BT	138	32956	90	3463321	250	3567751	238
31432	37	32400/40BT	138	32958	90	3463321	260	3567755	223
31434	37	32400/40CAT	138	32962	90	3533010	171	3567755	238
31434-F	41	32400/50BT	138	32964	90	3533010	256	3567761	223
31438	37	32400/50CAT	138	32984	90	3533010	259	3567761	238
31446	37	32400/INC1	139	32986	90	3533020	171	3568831	255
31456-E	41	3251239	223	32988	90	3533020	256	3568831	256
31462	37	3251239	238	32992	90	3533020	259	3568831	259

Part No.	Page	Part No.	Page	Part No.	Page	Part No.	Page	Part No.	Page
3568841	.255	3664419	.256	3862215	.256	39154	.105	41925	.62
3568841	.256	3664419	.258	3862215	.259	39304	.106	41932	.62
3568841	.259	3664421	.170	3862221	.256	39306	.106	41940	.62
3568851	.255	3664425	.170	3862221	.259	39308	.106	41950	.62
3568851	.256	3664431	.170	3862225	.256	39310	.106	42147-ER16	.137
3568851	.259	3665525	.258	3862225	.259	39311	.106	42150-25	.137
3568861	.255	3668011	.255	39.05.046.001	.130	39312	.106	42150-50	.137
3568861	.256	3668011	.256	39001-E	.103	39314	.106	42213-W-50	.39
3568861	.259	3668011	.258	39002-E	.103	39315	.106	42213-W-63	.39
3577715	.259	3668021	.255	39004-E	.103	39318	.106	42213-W-90	.39
3578011	.250	3668021	.256	39006-E	.103	39319	.106	42215-W-57	.39
3578011	.259	3668021	.258	39008-E	.103	39320	.106	42247-ER25	.137
3578016	.250	3668026	.255	39014-E	.103	39321	.106	42250-100	.137
3578016	.259	3668026	.256	39016-E	.103	39324	.106	42250-50	.137
3578021	.250	3668026	.258	39018-E	.103	39325	.106	42261-W	.39
3578021	.259	3732040	.171	39020-E	.103	39326	.106	42407-W	.39
3578026	.250	3732040	.256	39022-E	.103	39327	.106	4403502	.203
3578026	.259	3732040	.258	39024-E	.103	3934020	.171	4600076	.260
3631010	.170	3763336	.256	39025-E	.103	3934030	.171	4601437	.260
3663336	.170	3763336	.258	39082-E	.103	3954411	.223	4607257	.251
3663336	.256	3763337	.171	39084-E	.103	3954411	.238	4607257	.260
3663336	.258	3763337	.256	39088-E	.103	3954415	.223	4607261	.251
3663337	.170	3763337	.258	39090-E	.103	3954415	.238	4607261	.260
3663337	.256	3764421	.256	39092-E	.103	3954421	.223	4607265	.251
3663337	.258	3764421	.258	39110	.102	3954421	.238	4607265	.260
3663338	.170	3764424	.171	39111	.102	3954431	.223	4607277	.251
3663338	.256	3764424	.256	39113	.102	3954431	.238	4607277	.260
3663338	.258	3764424	.258	39114	.102	3954435	.223	4608011	.250
3663339	.170	3764427	.171	39115	.102	3954435	.238	4608011	.260
3663339	.256	3764427	.256	39117	.102	3959999	.220	4608016	.250
3663339	.258	3764427	.258	39119-4.13	.102	3959999	.223	4608016	.260
3663344	.170	3768811	.255	39132	.105	3959999	.238	4608021	.250
3663399	.170	3768811	.256	39134	.105	41111	.62	4608021	.260
3664411	.170	3768811	.258	39136	.105	41116	.62	4608026	.250
3664411	.256	3768821	.255	39138	.105	41120	.62	4608026	.260
3664411	.258	3768821	.256	39140	.105	41616	.62	4608031	.250
3664413	.170	3768821	.258	39142	.105	41620	.62	4608031	.260
3664413	.256	3768826	.255	39144	.105	41625	.62	46111	.62
3664413	.258	3768826	.256	39146	.105	41632	.62	46116	.62
3664416	.170	3768826	.258	39148	.105	41640	.62	46120	.62
3664416	.256	38032	.207	39150	.105	41916	.62	46125	.62
3664416	.258	38036	.207	39152	.105	41920	.62	46132	.62

Part No.	Page	Part No.	Page	Part No.	Page	Part No.	Page	Part No.	Page
46140	62	49019	203	6133270	172	6140350	176	6141332	175
48/13-4127	143	50001	41	6133272	173	6140375	176	6141335	174
48/13-4142	143	60/14-4381C	143	6133275	172	6140400	176	6141337	175
48/13-4158	143	60/14-4412C	143	6133277	173	6140425	176	6141340	174
48/13-4166C	143	60/14-4444C	143	6133280	172	6140450	176	6141342	175
48/13-4174	143	60/14-4476C	143	6133282	173	6140475	176	6141345	174
48/13-4190	143	6011000	159	6133285	172	6140500	176	6141347	175
48/13-4206	143	6011050	159	6133287	173	6140525	176	6141350	174
48/13-4209C	143	6011100	159	6133290	172	6140550	176	6141352	175
48/13-4222	143	6011150	159	6133292	173	6141250	174	6141355	174
48/13-4238	143	6011200	159	6133295	172	6141252	175	6141360	174
48/13-4254	143	6011250	159	6133297	173	6141255	174	6141362	175
48/13-4264C	143	6011300	159	6133300	184	6141257	175	6141365	174
48/13-4286	143	6022510	180	6133305	184	6141260	174	6150100	177
48/13-4317	143	6033311	183	6133310	184	6141262	175	6150125	177
48/13-4332C	143	6033322	183	6133315	184	6141265	174	6150150	177
48/13-4349	143	6033333	183	6134300	172	6141267	175	6150175	177
48/13-SET	143	6033344	183	6134302	173	6141270	174	6150200	177
48/3-4127	142	6033355	183	6134305	172	6141272	175	6150225	177
48/3-4142	142	6033366	183	6134307	173	6141275	174	6150250	177
48/3-4158	142	6033377	183	6134310	172	6141277	175	6150275	177
48/3-4166C	142	6033388	183	6134312	173	6141280	174	6150300	177
48/3-4174	142	6033399	183	6134315	172	6141282	175	6150325	177
48/3-4190	142	60TH	205	6134317	173	6141285	174	6150350	177
48/3-4206	142	6123300	184	6134320	172	6141287	175	6150375	177
48/3-4209C	142	6123305	184	6134322	173	6141290	174	6150400	177
48/3-4222	142	6123310	184	6134325	172	6141292	175	6150425	177
48/3-4238	142	6123315	184	6134327	173	6141295	174	6150450	177
48/3-4254	142	6123320	184	6134330	172	6141297	175	6150475	177
48/3-4264C	142	6130100	176	6134332	173	6141300	174	6150500	177
48/3-4286	142	6130150	176	6134335	172	6141302	175	6150525	177
48/3-4317	142	6130200	176	6134340	172	6141305	174	6150550	177
48/3-4332C	142	6130250	176	6140100	176	6141307	175	6150575	177
48/3-4349	142	6130300	176	6140125	176	6141310	174	6150600	177
48/3-SET	142	6133250	172	6140150	176	6141312	175	6150625	177
49001	202	6133252	173	6140175	176	6141315	174	6150650	177
49001-45	203	6133255	172	6140200	176	6141317	175	6150675	177
49003	202	6133257	173	6140225	176	6141320	174	6155101	178
49005	202	6133260	172	6140250	176	6141322	175	6155102	178
49011	202	6133262	173	6140275	176	6141325	174	6155103	178
49013	202	6133265	172	6140300	176	6141327	175	6155104	178
49015	202	6133267	173	6140325	176	6141330	174	6155105	178

Part No.	Page	Part No.	Page	Part No.	Page	Part No.	Page	Part No.	Page
6155106	.178	6275150	.160	6275360	.165	6390290	.166	6444295	.183
6155107	.178	6275155	.160	6275365	.165	6390295	.166	6445472	.183
6155108	.178	6275160	.160	6275370	.165	6390300	.166	6445490	.183
6155501	.178	6275165	.160	6275375	.165	6390305	.166	6446810	.183
6155502	.178	6275170	.160	6275380	.165	6390310	.166	6448510	.183
6155503	.178	6275175	.160	6390100	.162	6390315	.166	64500	.107
6155504	.178	6275180	.160	6390105	.162	6390320	.166	64625	.107
6155631	.178	6275185	.160	6390110	.162	6390325	.166	64750	.107
6155632	.178	6275190	.160	6390115	.162	6390330	.166	6551012	.182
6155633	.178	6275195	.160	6390120	.162	6390335	.166	6551080	.182
6155634	.178	6275200	.160	6390125	.162	6390340	.166	6552220	.182
6155635	.178	6275205	.160	6390130	.162	6390345	.166	6552230	.182
6155636	.178	6275210	.161	6390135	.162	6390350	.166	6552730	.182
6165101	.179	6275215	.161	6390140	.162	6390355	.166	6552745	.182
6165102	.179	6275220	.161	6390145	.162	6390360	.166	6553235	.182
6165103	.179	6275225	.161	6390150	.162	6390365	.167	6553252	.182
6165121	.179	6275230	.161	6390155	.162	6390370	.167	6554240	.182
6165122	.179	6275235	.161	6390160	.162	6390375	.167	6554260	.182
6165123	.179	6275240	.161	6390165	.162	6390380	.167	6555450	.182
6165141	.179	6275245	.161	6390170	.162	6390385	.167	6555475	.182
6165142	.179	6275250	.161	6390175	.162	6390390	.167	6556860	.182
6165143	.179	6275255	.164	6390180	.162	6390395	.167	6556890	.182
6165144	.179	6275260	.164	6390185	.162	6390400	.167	6558510	.182
6165341	.179	6275265	.164	6390190	.162	6390405	.167	6558570	.182
6165342	.179	6275270	.164	6390200	.162	64.05.046.051	.130	6561080	.182
6165343	.179	6275275	.164	6390205	.162	64110	.107	6562230	.182
6165801	.179	6275280	.164	6390210	.163	64250	.107	6562730	.182
6165802	.179	6275285	.164	6390215	.163	64375	.107	6563235	.182
6165803	.179	6275290	.164	6390220	.163	6442210	.183	6564240	.182
6165804	.179	6275295	.164	6390225	.163	6442236	.183	6565450	.182
6165805	.179	6275300	.164	6390230	.163	6442240	.183	6566860	.182
6166123	.180	6275305	.164	6390235	.163	6442258	.183	6568570	.182
6166124	.180	6275310	.164	6390240	.163	6442286	.183	6600060	.258
6275100	.160	6275315	.164	6390245	.163	6442734	.183	6601436	.258
6275105	.160	6275320	.164	6390250	.163	6442750	.183	6602117	.236
6275115	.160	6275325	.164	6390255	.166	6442780	.183	6602118	.236
6275120	.160	6275330	.164	6390260	.166	6442795	.183	6607029	.170
6275125	.160	6275335	.164	6390265	.166	6443246	.183	6607029	.251
6275130	.160	6275340	.165	6390270	.166	6443276	.183	6607029	.258
6275135	.160	6275345	.165	6390275	.166	6443290	.183	6607033	.170
6275140	.160	6275350	.165	6390280	.166	6444270	.183	6607033	.251
6275145	.160	6275355	.165	6390285	.166	6444282	.183	6607033	.258

Part No.	Page	Part No.	Page	Part No.	Page	Part No.	Page	Part No.	Page
6607037	.170	6675130	.168	6733225	.158	6811570	.270	7189060	.101
6607037	.251	6675135	.168	6733227	.158	6811580	.270	7189064	.101
6607037	.258	6675140	.168	6733230	.158	6811590	.270	7189068	.101
6607041	.170	6675145	.168	6733232	.158	6921235	.150	72225	.22
6607041	.251	6675150	.168	6733235	.158	6921236	.150	72227	.22
6607041	.258	6690125	.168	6733237	.158	6921237	.150	72231	.22
6607045	.170	6690130	.168	6733245	.158	6921238	.150	72233	.22
6607045	.251	6690135	.168	6733247	.158	6921239	.150	72253	.22
6607045	.258	6690140	.168	6733255	.158	6921240	.150	72255	.22
6607901	.170	6690145	.168	6733257	.158	6921241	.150	72257	.22
6607901	.251	6690150	.168	6733265	.158	6921242	.150	72261	.22
6607901	.258	6690155	.168	6733267	.158	6921243	.150	72281	.28
6607905	.170	6690160	.168	67375	.102	6922243	.150	72285	.28
6607905	.251	6690165	.168	67500	.102	6943333	.150	72287	.28
6607905	.258	6690170	.168	67625	.102	6943334	.150	72311	.28
6608011	.250	6690175	.168	67750	.102	6943335	.150	72313	.28
6608011	.258	6690180	.168	6811210	.270	6943336	.150	72317	.28
6608016	.250	67.05.046.001	.130	6811215	.270	6943337	.150	72321	.28
6608016	.258	6702119	.236	6811220	.270	6943338	.150	72711	.115
6608021	.250	6702120	.236	6811230	.270	6951234	.150	72711-4	.115
6608021	.258	6711225	.157	6811235	.270	6962234	.150	72711-6	.115
6608026	.250	6711235	.157	6811240	.270	6962235	.150	72713	.115
6608026	.258	6711245	.157	6811250	.270	6962236	.150	72713-4	.115
6608031	.250	6711255	.157	6811255	.270	6962238	.150	72713-6	.115
6608031	.258	6711265	.157	6811256	.270	6972215	.150	72715	.115
6608036	.250	6711275	.157	6811257	.270	6972236	.150	72715-4	.115
6608036	.258	6712119	.233	6811259	.270	6972237	.150	72715-6	.115
66102	.30	6712120	.233	6811260	.270	6991230	.149	72717	.115
66103	.30	67130-0.125-2.5	.85	6811262	.270	6991235	.148	72717-4	.115
66104-105	.30	67130-0.1875-2.5	.85	6811266	.270	6991240	.150	72721	.117
66106-105	.30	67130-0.25-2.5	.85	6811270	.270	71010	.107	72721-3.5	.117
66106-60	.30	67130-0.375-2.5	.85	6811280	.270	71011	.107	72721-5.5	.117
66106-90	.30	67130-0.5-2.5	.85	6811290	.270	71100	.107	72723	.117
66109-60	.30	67130-0.625-2.5	.85	6811310	.270	71250	.107	72723-4	.117
66113-60	.30	67130-0.75-3	.85	6811320	.270	71312	.107	72723-6	.117
66113-90	.30	6722225	.157	6811410	.270	71375	.107	72725	.117
66115	.30	6722235	.157	6811510	.270	71500	.107	72725-3.5	.117
6612117	.233	6722245	.157	6811520	.270	71625	.107	72725-6	.117
6612118	.233	6722255	.157	6811530	.270	71750	.107	72727	.117
66610	.118	6722265	.157	6811540	.270	7189027	.101	72727-4	.117
66612-2	.118	6722275	.157	6811550	.270	7189036	.101	72727-6	.117
6675125	.168	67250	.102	6811560	.270	7189042	.101	72727-8	.117

Part No.	Page	Part No.	Page	Part No.	Page	Part No.	Page	Part No.	Page
72729	117	7607061	251	8167755	253	83512-5/16	70	84063-17/32	68
72729-4	117	7607061	259	8167766	253	83512-7/16	70	84063-19/32	68
72917	79	7607065	251	8167777	253	83531-1/2	70	84063-21/32	68
72917-4.63	79	7607065	259	8167788	253	83531-1/4	70	84063-23/32	68
72919	79	7607069	251	8168811	248	83531-1/8	70	84063-25(SET)	68
72920	79	7607069	259	8168812	248	83531-10	70	84063-25/32	68
72920-5.75	79	7607073	251	8168813	248	83531-16	70	84063-27/32	68
72921	79	7607073	259	8168821	248	83531-3/16	70	84063-29/32	68
72921-5	79	7607077	251	8168822	248	83531-3/8	70	84063-3/4	68
72925	79	7607077	259	8168823	248	83531-5/16	70	84063-3/8	68
72925-6	79	7607909	251	8177711	253	83531-5/8	70	84063-31/32	68
72927	79	7607909	258	8177722	253	83531-7/16	70	84063-5/16	68
72927-4	79	7607913	251	8177733	253	83531-9/16	70	84063-5/8	68
72927-6	79	7607913	258	8177744	253	83632	70	84063-7/16	68
72929	79	7608011	250	8177755	253	83634	70	84063-7/8	68
72937	84	7608011	258	8177766	253	83634-L	70	84063-9/16	68
72937-6	84	7608016	250	8177777	253	83868-1	70	84063-9/32	68
72939	84	7608016	259	8177788	253	83868-1/2	70	84126-06	124
72939-6	84	7608021	250	8178831	248	83868-1/4	70	84126-08	124
72941	84	7608021	259	8178832	248	83868-1/8	70	84126-1/2	124
72941-1.44	84	7608026	250	8178833	248	83868-10	70	84126-1/4	124
72941-3	84	7608026	259	8178841	248	83868-16	70	84126-1/8	124
72941-6	84	7608031	250	8178842	248	83868-20	70	84126-10	124
72945	84	7608031	259	8178843	248	83868-25	70	84126-12	124
72945-2.62	84	79011F	97	8188851	249	83868-3/16	70	84126-3/16	124
72945-6	84	79021F	97	8188852	249	83868-3/4	70	84126-3/8	124
72947	84	79027B	97	8188861	249	83868-3/8	70	84126-5/16	124
72947-2.62	84	79027F	97	8188862	249	83868-5/16	70	84126-5/8	124
72947-6	84	79036B	97	8188873	249	83868-5/8	70	84126-7/16	124
72947-8	84	79036B	97	8188881	249	83868-7/16	70	84126-9/16	124
72949	84	79036F	97	8188882	249	83868-7/8	70	84127-08	124
72949-8	84	79042F	97	8188883	249	83868-9/16	70	84127-1	124
73202G	123	79046F	97	83508-1/4	70	84012	66	84127-1/2	124
73210G	123	8148871	249	83508-1/8	70	84063-1	68	84127-1/4	124
73214G	123	8148872	249	83508-3/16	70	84063-1/2	68	84127-1/8	124
73222G	123	8157711	254	83508-NUT	70	84063-1/4	68	84127-10	124
73528	104	8157722	254	83512-1/2	70	84063-11/16	68	84127-12	124
73538	104	8157733	254	83512-1/4	70	84063-11/32	68	84127-14	124
73548	104	8167711	253	83512-1/8	70	84063-13/16	68	84127-16	124
73568	104	8167722	253	83512-10	70	84063-13/32	68	84127-20	124
73588	104	8167733	253	83512-3/16	70	84063-15/16	68	84127-25	124
750-19	203	8167744	253	83512-3/8	70	84063-15/32	68	84127-3/16	124

Part No.	Page	Part No.	Page	Part No.	Page	Part No.	Page	Part No.	Page
84127-3/4	124	8655512	252	93116	104	9319345	220	9345222	270
84127-3/8	124	8655523	252	93117	104	9319345	270	9345333	270
84127-5/16	124	8655534	252	93117B	105	9319345	270	93500	120
84127-5/8	124	8655545	252	93118	104	9319446	270	93501	120
84127-7/16	124	8665511	252	93119	104	9319547	270	93502	120
84127-7/8	124	8665522	252	93119B	105	9319648	270	93510	120
84127-9/16	124	8665533	252	93120	104	9322111	270	93520	120
86062	108	8665544	252	93121	104	9322116	270	93530	120
86064	108	8669911	246	93121B	105	9322121	270	9353123	218
86066	108	8669912	246	9312345	270	9322126	270	9355111	270
8607241	251	8675555	252	93124	104	9333111	270	9355222	270
8607241	260	8675566	252	93124B	105	9333222	270	9355321	270
8607245	251	8675577	252	93126	104	9333252	270	9355333	270
8607245	260	8675588	252	93128	104	9333333	270	9355444	270
86076	108	8679921	246	93130	104	9333353	270	9355555	270
8607921	251	8679922	246	9313345	270	9333444	270	9355666	270
8607921	259	8689931	247	93135	104	9333555	270	9363123	214
8607925	251	8689932	247	93140	104	9333666	270	9396762	234
8607925	260	894-22	53	9314345	270	9333757	270	9396763	234
86080	108	894-22	204	93145	104	9333777	270	9396764	234
8608011	250	894-36	204	9315345	270	9333888	270	9396766	234
8608011	260	92002	37	9315446	270	9333999	270	9397764	234
8608016	250	92003	37	9316446	232	9335111	270	9398765	234
8608016	260	92004	37	9316446	270	9335222	270	9474123	218
8608831	255	92005	37	9316547	270	9335333	270	9484123	214
8608831	256	9202123	218	9317345	270	9344111	270	95901	120
8608831	259	9212124	218	9317446	221	9344222	270	95903	120
8608836	255	9223123	214	9317446	270	9344333	270	95905	120
8608836	256	9233124	214	9317547	270	9344444	270	95907	120
8608836	259	9311311	270	9318345	213	9344454	270	99528	103
86090	108	93113B	105	9318345	270	9344555	270	99538	103
86092	108	9311455	270	9318446	270	9344666	270	99548	103
86094	108	93114B	105	9318547	221	9344777	270	99568	103
8649941	247	93115	104	9318547	270	9344888	270	99588	103
8649942	247	93115B	105	9319345	212	9345111	270		